

INGO MAURER

Ingo Maurer GmbH
Kaiserstrasse 47
80801 München
Germany
T. +49.89.381606-0
F. +49.89.381606 20
info@ingo-maurer.com
www.ingo-maurer.com

Juli 2019



Made in Germany

Ringelpiez Flying Disc Instructions

Important instructions for assembly - please read!

The assembly and all electrical work must be carried out by a qualified electrician.

Switch off or remove the mains fuse before beginning the assembly. Take care to ascertain the exact position of all electrical wiring, so as to avoid accidentally drilling into a power cable. Do not attach the lamp to a damp and/or conductive surface. Any repairs that may become necessary must be carried out by a qualified electrician. In the event of damage to the external power cord, replacements may only be fitted by Ingo Maurer GmbH.

► Cleaning

The lamp can be cleaned with a dry microfiber cloth. DO NOT use cleaning agents containing solvents or chlorine.

► Technical specification

220-240/100-125 V, 50/60 Hz. Secondary 36 V.

25 W LED, 0.92 cos, rated current 700 mA, 1643 lm, 2700 K,

CRI>90, dimmable. With transformer integrated in the ceiling box. According to the manufacturer, the LEDs have an average life of 25 000 hours.

The lamp is supplied with built-in LEDs of energy class

A+, which cannot be replaced by the user.

Ceiling assembly / drill three holes triangular into the ceiling

1

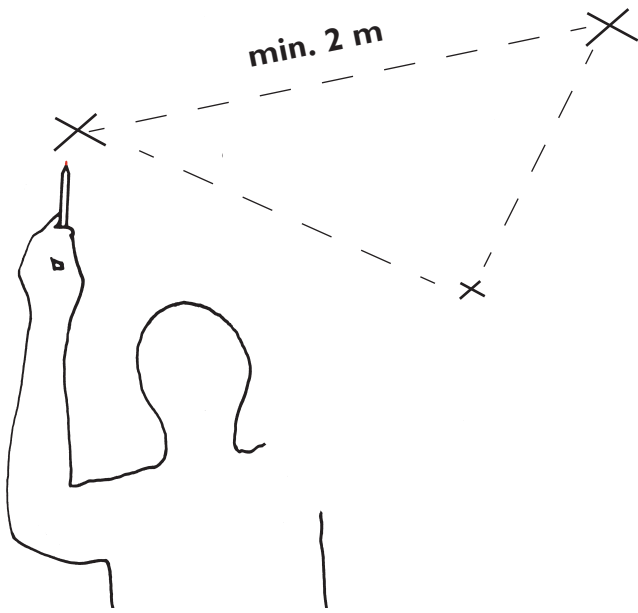

adjust the screw and the cable holder / insert the cable into the cableholder (fig. 3A)

Important: Do not pull the cable through the holder when it is taut; otherwise it will become twisted.

2

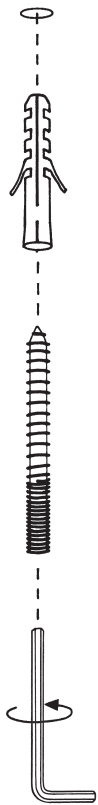

3 X

3

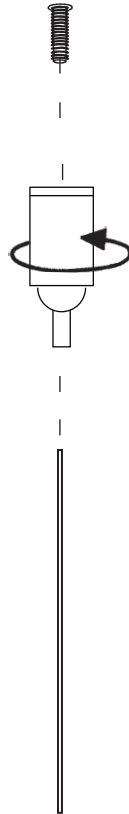

3 X

3A

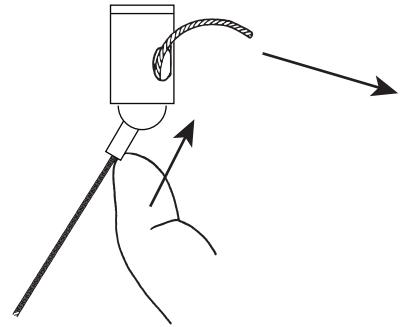

lift the disc by using white handcloves and insert the cable into the cable holder.
To adjust the height of the lamp, press the cable holder (fig. **4A**) to release the cable, which can then be pulled up or let down as required. The release mechanism will only work if the cable is slack. **4B** Finally shorten the cable.

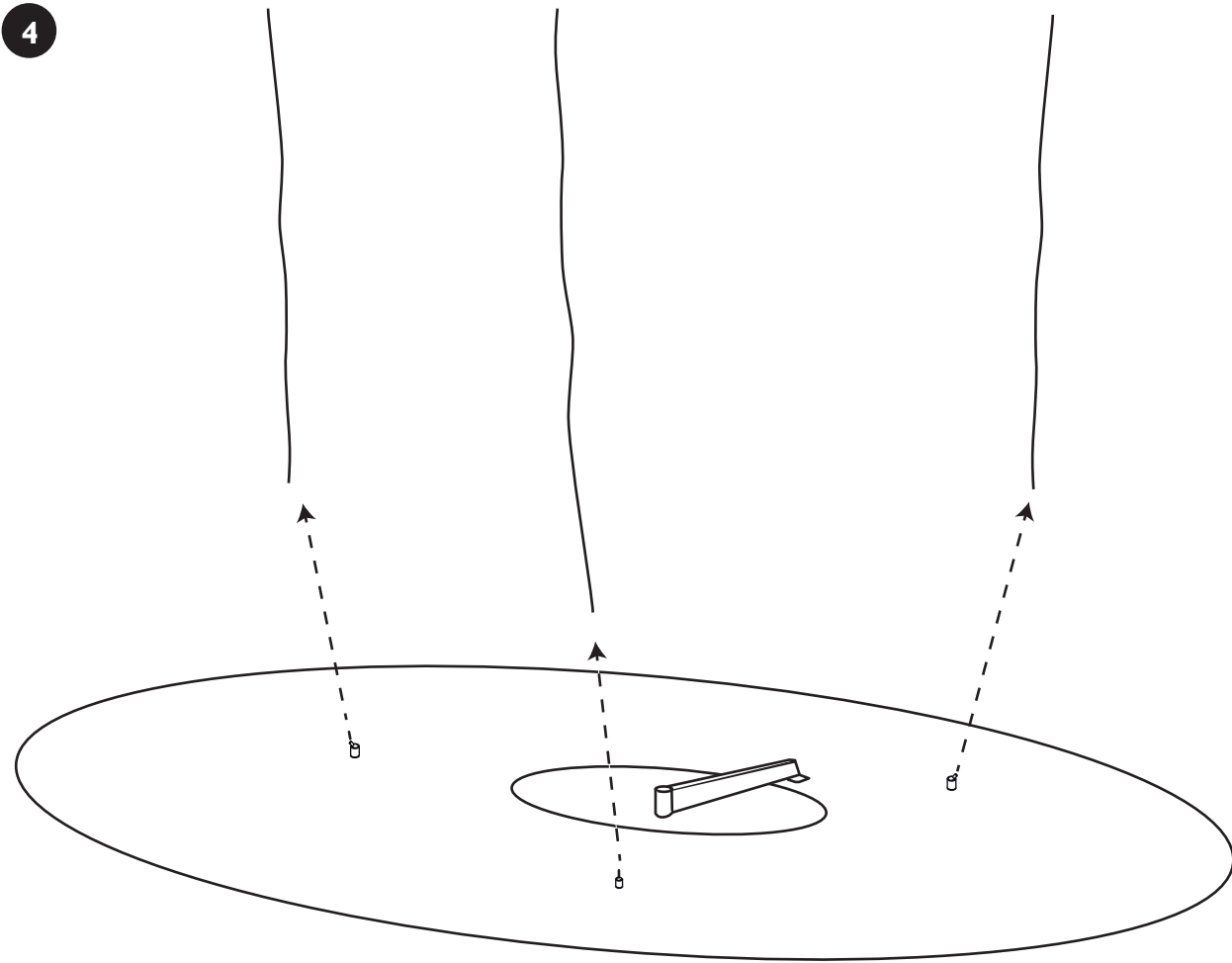

4A

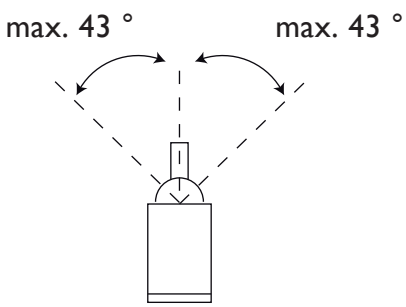

4B

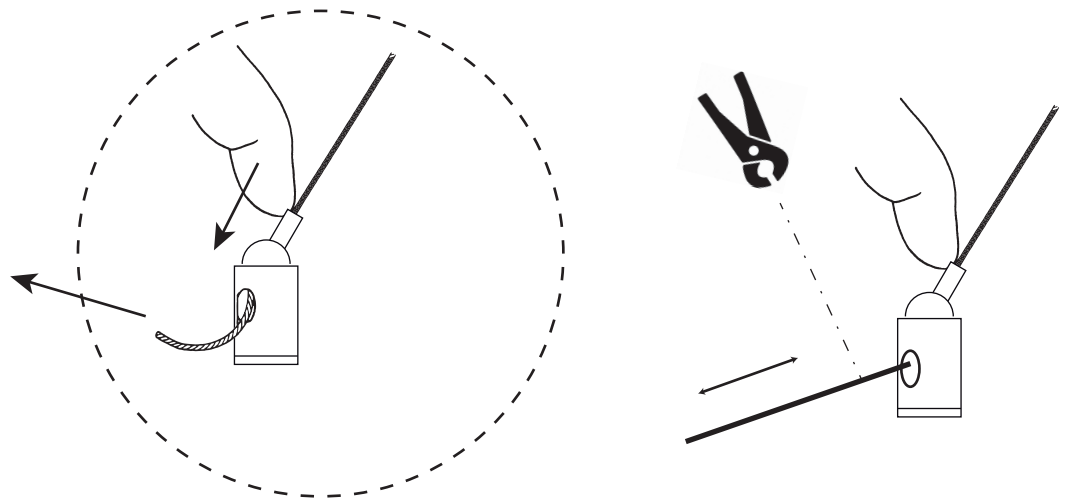

5 Place the pole into the holder. Start with the cable. **5A** Fix the pole by tighten the two screws

5

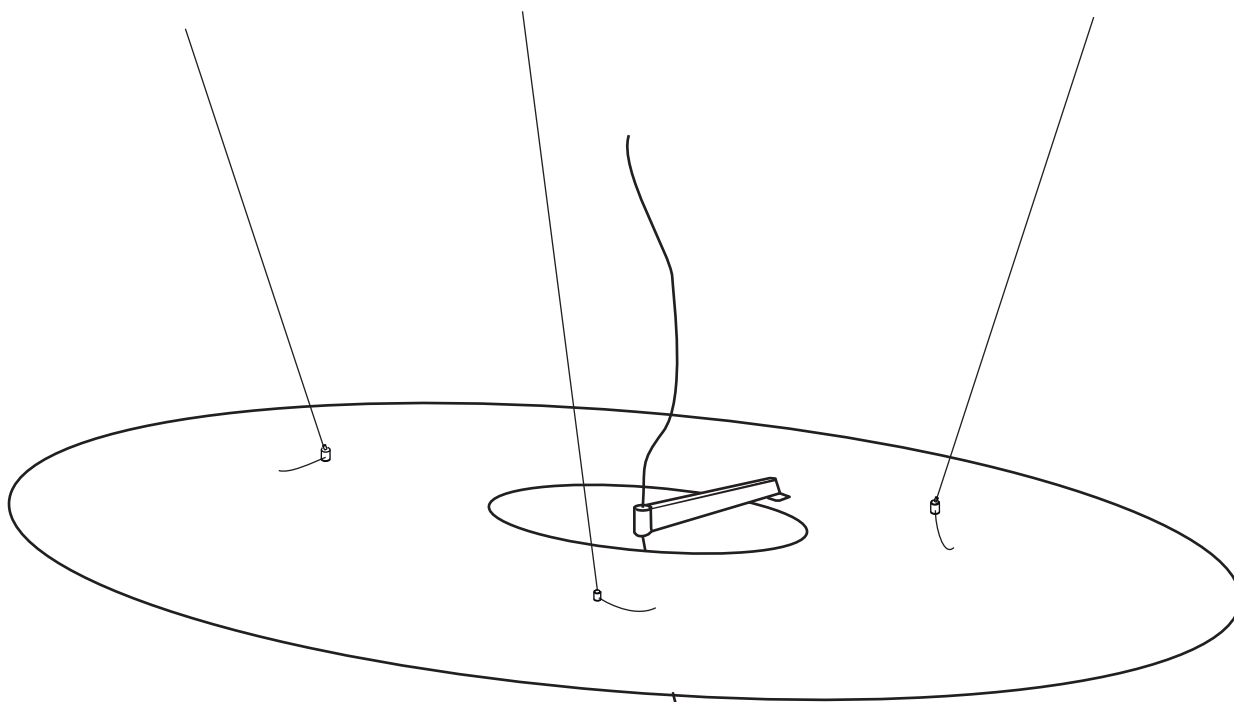

5A

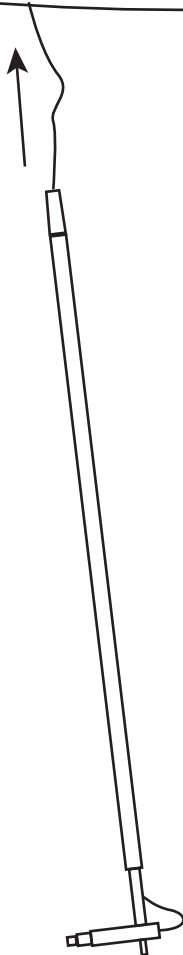
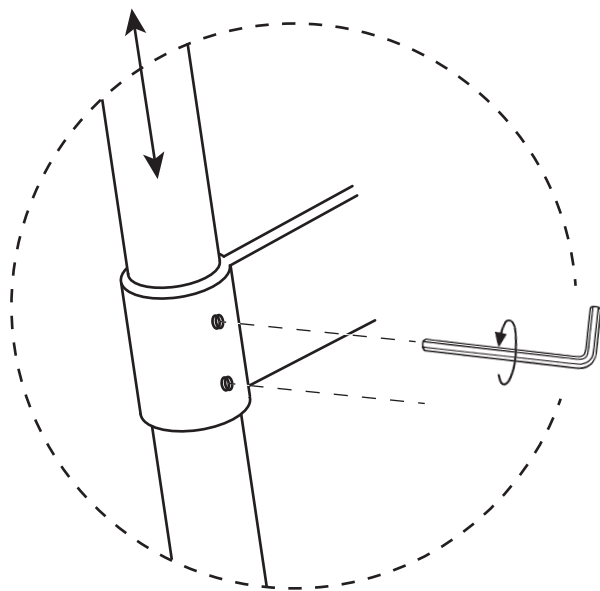

6 Assemble the tapered rod / Screw the tapered rod into the lamp pole.
Fit the ring over the rod, so that the LEDs directed upwards.

7 Attach the ring by by connecting the two fixtures together.

6

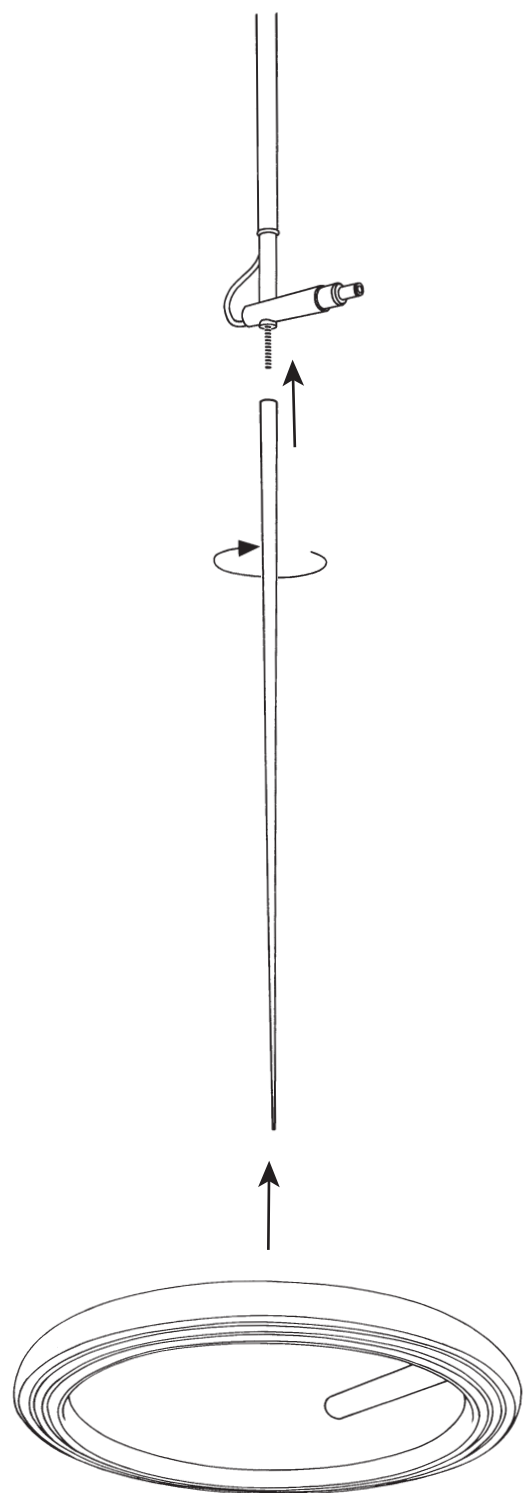

7

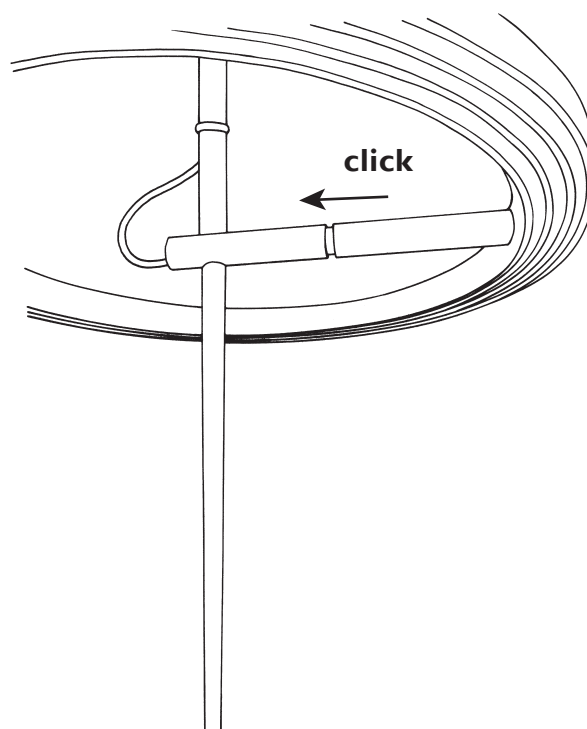

8 The telescopic fitting is adjustable by up to 60 cm

8

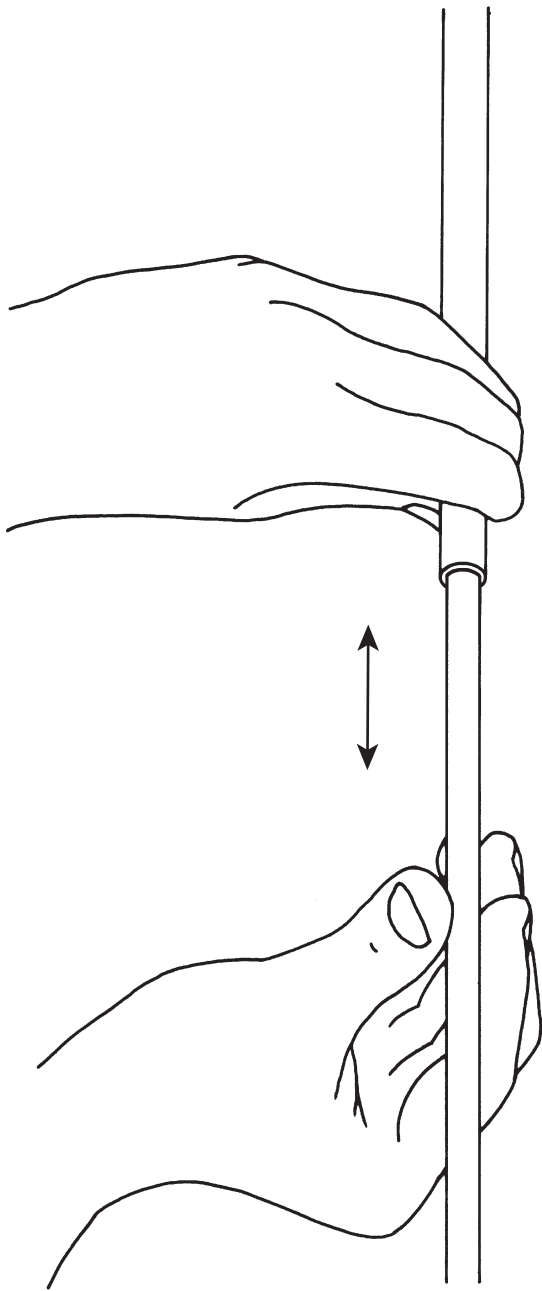

9 Mounting the ceiling box

Open the ceiling box with the allen key. Drill two 6 mm-diameter holes, insert the plugs and attach the box. Connect the phase (L) and neutral (N) wires to the mark contacts in the terminal.

9

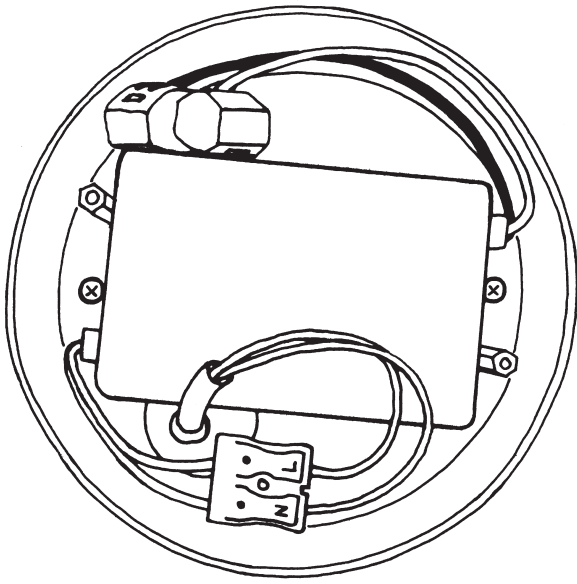

10 Connect the wires to the two terminal clamps and pay attention that the polarity is correct.

Important: The red wire must be connected to the terminal clamp on the red lead, and the black wire to the terminal on the black lead!

11 Close the ceiling box / Attach the cover to the ceiling box with the screws provided.

10

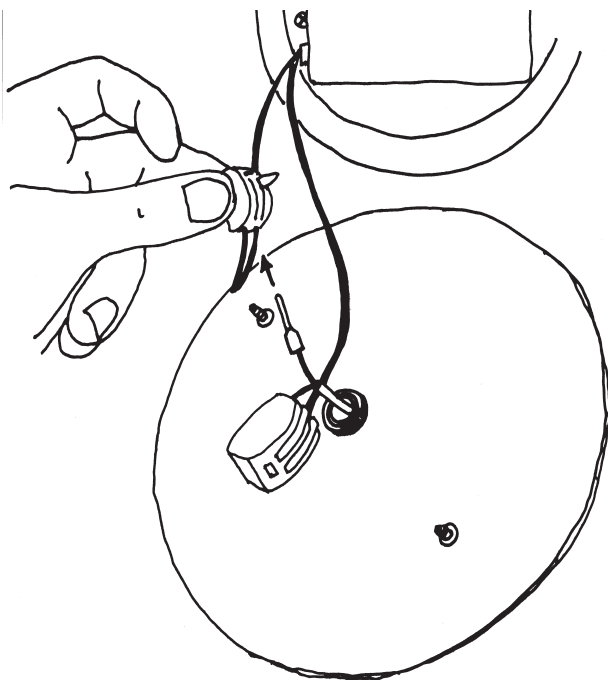

11

