



CC20W350-500CG Triac/CC20W500-700CG Triac/CC20W700-900CG Triac



**Constant Current & Dimmable Driver**

**Model:** CC20W350-500CG Triac  
 CC20W500-700CG Triac  
 CC20W700-900CG Triac



Model	Output Current (230V Full Load)	Input Current (230V Full Load)	Input Power (230V Full Load)	Output Power Range	PF (Full Load)	Efficiency (Full Load)	Output Voltage	No load Voltage
CC20W350-500CG Triac	500mA	0.15A	25W	9.1-19W	0.92	84%	26-38V	55V
CC20W500-700CG Triac	700mA	0.15A	25W	7.5-19.6W	0.92	84%	15-28V	43V
CC20W700-900CG Triac	900mA	0.15A	25W	9.8-19.8W	0.92	84%	14-22V	35V

## 1. Parameters

category	Item	Technical Norm
Features	Output Type	Constant Current
	Dimming Type	Phase dimming
	Dimming Range	10%-100%
	IP Grade	IP20
	Insulation Class	Class II
Input	Rated Input Voltage	220-240VAC
	Range of Input Voltage	198-264VAC
	Frequency	50/60Hz
	Input Current	≤0.15A (198VAC, full load)
	Input Power	≤25W (230VAC, full load)
	Power Factor	≥0.92 (230VAC, full load)
	THD	≤20% (230VAC, full load)
	No-load Power Consumption	≤0.5W @230VAC
	Inrush Current	≤20A/10us (230VAC, full load)
	Connected quantity of 16A Breaker :	11pcs/type B ; 18pcs/type C @ 230Vac
Output Voltage	CC20W350-500CG Triac	26-38V
	CC20W500-700CG Triac	15-28V
	CC20W700-900CG Triac	14-22V
Output Current	CC20W350-500CG Triac	350mA/400mA/450mA/500mA
	CC20W500-700CG Triac	500mA/550mA/600mA/700mA
	CC20W700-900CG Triac	700mA/800mA/850mA/900mA
No Load	CC20W350-500CG Triac	55VDC Max.



## CC20W350-500CG Triac/CC20W500-700CG Triac/CC20W700-900CG Triac

Voltage	CC20W500-700CG Triac	43VDC Max.
	CC20W700-900CG Triac	35VDC Max.
Output	Max. Output Power	19.8W
	Efficiency	≥84% (230VAC, full load)
	Current Ripple	± 10% (230VAC, full load)
	Current Accuracy	± 5%
	Started Delay Time	≤0.5S (230VAC, full load)
Protection	Short Circuit Protection	Auto Recovery
	Overload Protection	Auto Recovery
	No-load Protection	Auto Recovery
	Insulation voltage	I/P to O/P , 3.75KVac/1min
	Ta/Operation Temperature	-25....+50 °C
Environment	Ts/Storage Temperature	-40....+85 °C
	Tc/Enclosure Temperature	85 °C
	Humidity	10%....90%RH
	Atmosphere	86-108KPa
	Connection Method	Push-in Terminal
Construction	Installation	Independent & Built in
	PRI Wire preparation	0.75-1.5 <sup>□</sup>
	SEC Wire preparation	0.5-1.5 <sup>□</sup>
	Dimension	Independent:137.6*44*30mm (L*W*H) Built in:97.8*44*30mm(L*W*H)
	Certification	complied to CE ENEC SAA
Standards	Safety Standards	EN61347-1:2015,EN61347-2-13:2014/A1:2017 ,EN62493:2015,AS/NZSIEC61347.2.13:2013, AS/NZS 61347.1:2016
	EMC Standards	EN55015:2013/A1:2015,EN61000-3-2:2014,E N61000-3-3:2013,EN61547:2009
	Performance	EN62384
	Surge	L-N/1KV
	RoHS	complied to 2011/65/EU
Others	Life Time	50000h @50 °C (Ta) / 85 °C (Tc)
	Warranty	5years , F.R. < 10000ppm

Remark: 1. Specific instructions are not all parameters are not connect dimmer input voltage 230 vac / 50 Hz and 25 °C ambient temperature measured.

2. LED Driver is a component of the luminaires, Luminaires and wire layout will affect the EMC, please check the EMC with end products again.

3. Leading edge & trailing edge dimmable.

**2. Trailing Edge Dimmer list approved by KGP**

<b>Manufacturer</b>	<b>Model</b>	<b>Q'ty of parallel connection</b>
ABB	6519 U	12
ABB	6526 U	11
JUNG	1224 LED UDE	12
Berker	2861	12
JUNG	254 UDIE 1	13
JUNG	225 TDE	12
EGANT	U321V2	12
Schneider	SBD200LED	13
Schneider	SBD315RC	12
Merten	SBD200LED	13
Berker	2874	12
Eltako	EUD61NPL-230V	10
Eltako	EUD12NPN-UC	10
Eltako	EUD12D-UC	10
Eltako	EUD61NP-230V	10
Eltako	DTD55L-230V-wg	10
GIRA	Universal-LED-Dimmer Mini2440 00	10
EHMANN	LED-Dimmer T46.08	9
JUNG	Drehldimmer Unlversal LED1731DD	10
EHMANN	LED-Dimmer T46.03	10

***Leading Edge Dimmer list only on request -/ or confirmed by KGP Electronics***

### 3. Label



**KGP** LED Dimmable Driver  
 KGP Electronics GmbH  
 Hueckstraße 19  
 DE-58511 Lüdenscheid

**CC20W350-500CG Triac** R,C

Constant Current Type For LED modules only



$U_N = 220-240\text{Vac}$  50/60Hz  $\lambda: \geq 0.92\text{C}$   
 $U_{out} = \text{Max. } 55\text{Vdc SELV}$

PIN1	PIN2	Io (mA)	Po (W)	Uout(V)	Ii (A)
OFF	OFF	350	13.3	26-38	0.13
OFF	ON	400	15.2		0.15
ON	OFF	450	17.1		
ON	ON	500	19		

8mm  
 PRI 0. 75-1. 5 □  
 SECO. 5-1. 5 □  
 ●  $t_c = 85^\circ\text{C}$   
 $t_a = -20^\circ\text{C} - +50^\circ\text{C}$

**EAC**



**KGP** LED Dimmable Driver  
 KGP Electronics GmbH  
 Hueckstraße 19  
 DE-58511 Lüdenscheid

**CC20W500-700CG Triac** R,C



Constant Current Type For LED modules only



$U_N = 220-240\text{Vac}$  50/60Hz  $\lambda: \geq 0.92\text{C}$   
 $U_{out} = \text{Max. } 43\text{Vdc SELV}$

PIN1	PIN2	Io (mA)	Po (W)	Uout(V)	Ii (A)
OFF	OFF	500	14	15-28	0.13
OFF	ON	550	15.4		0.15
ON	OFF	600	16.8		
ON	ON	700	19.6		

8mm  
 PRI 0. 75-1. 5 □  
 SECO. 5-1. 5 □  
 ●  $t_c = 85^\circ\text{C}$   
 $t_a = -20^\circ\text{C} - +50^\circ\text{C}$

**EAC**

**KGP** LED Dimmable Driver  
 KGP Electronics GmbH  
 Hueckstraße 19  
 DE-58511 Lüdenscheid

**CC20W700-900CG Triac** R,C

Constant Current Type For LED modules only

$U_N = 220-240\text{Vac}$  50/60Hz  $\lambda: \geq 0.92\text{C}$   
 $U_{out} = \text{Max. } 35\text{Vdc SELV}$

PIN1	PIN2	Io (mA)	Po (W)	Uout(V)	Ii (A)
OFF	OFF	700	15.4	14-22	0.13
OFF	ON	800	17.6		0.15
ON	OFF	850	18.7		
ON	ON	900	19.8		

8mm  
 PRI 0. 75-1. 5 □  
 SECO. 5-1. 5 □  
 ●  $t_c = 85^\circ\text{C}$   
 $t_a = -20^\circ\text{C} - +50^\circ\text{C}$

**EAC**



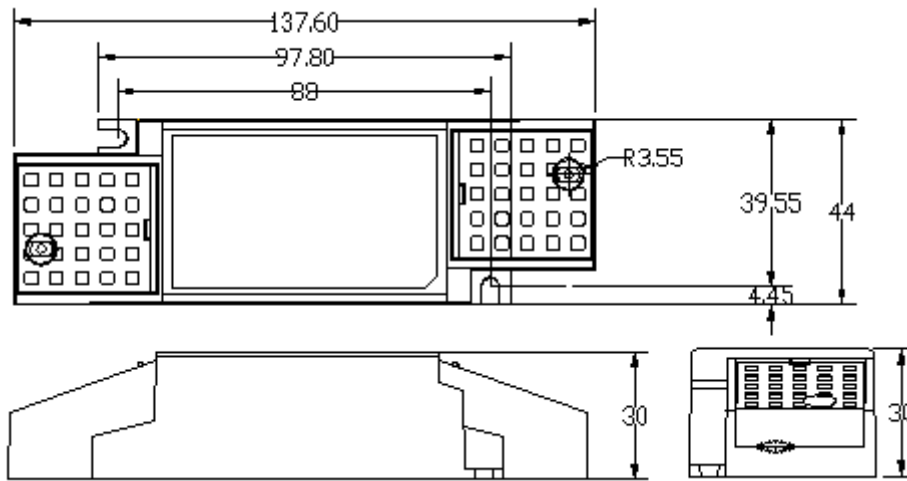

## 4. Dimension (Unit: mm)

Independent type:

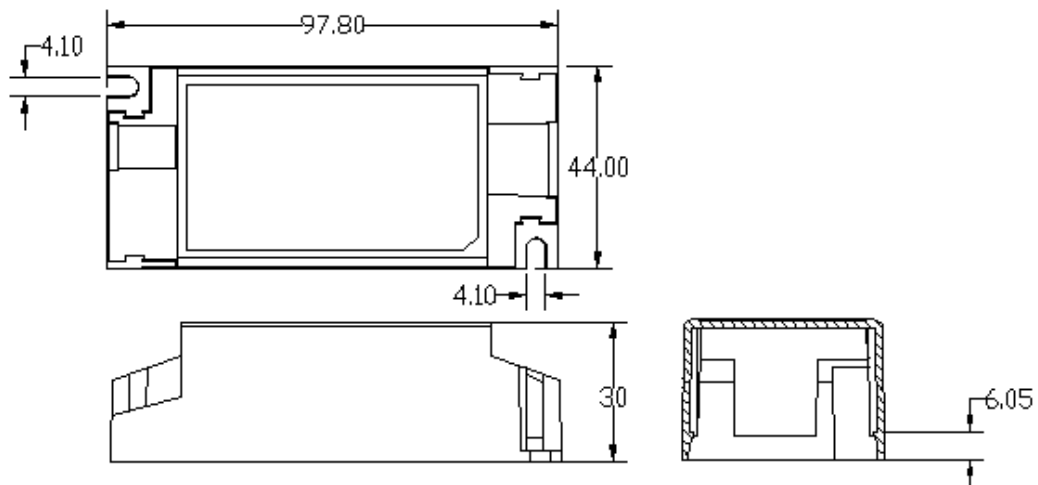

Built in type:



## 5. Packing information

Carton L*W*H(mm)	Pcs/Carton	Net weight/ Pcs(kg)	Net weight/ Carton(kg)	Gross weight / Carton(kg)
450*240*200	70	0.105	7.35	9

## 6. Wiring Diagram

Independent type:

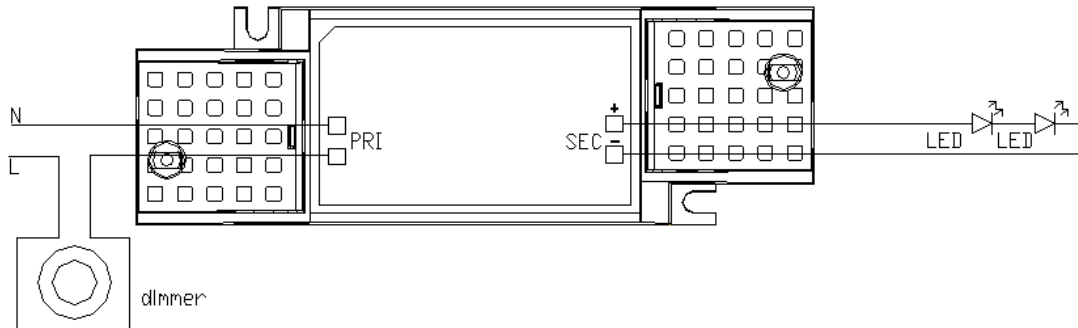

Built in type:

