

Luna Black Round M  
2869.350

Before mounting this mirror go to  
[deknudtmirrors.com](https://deknudtmirrors.com) | Products | Luna Black Round M | scroll to WATCH INSTRUCTION VIDEO

suspension accessories delivered with the mirror

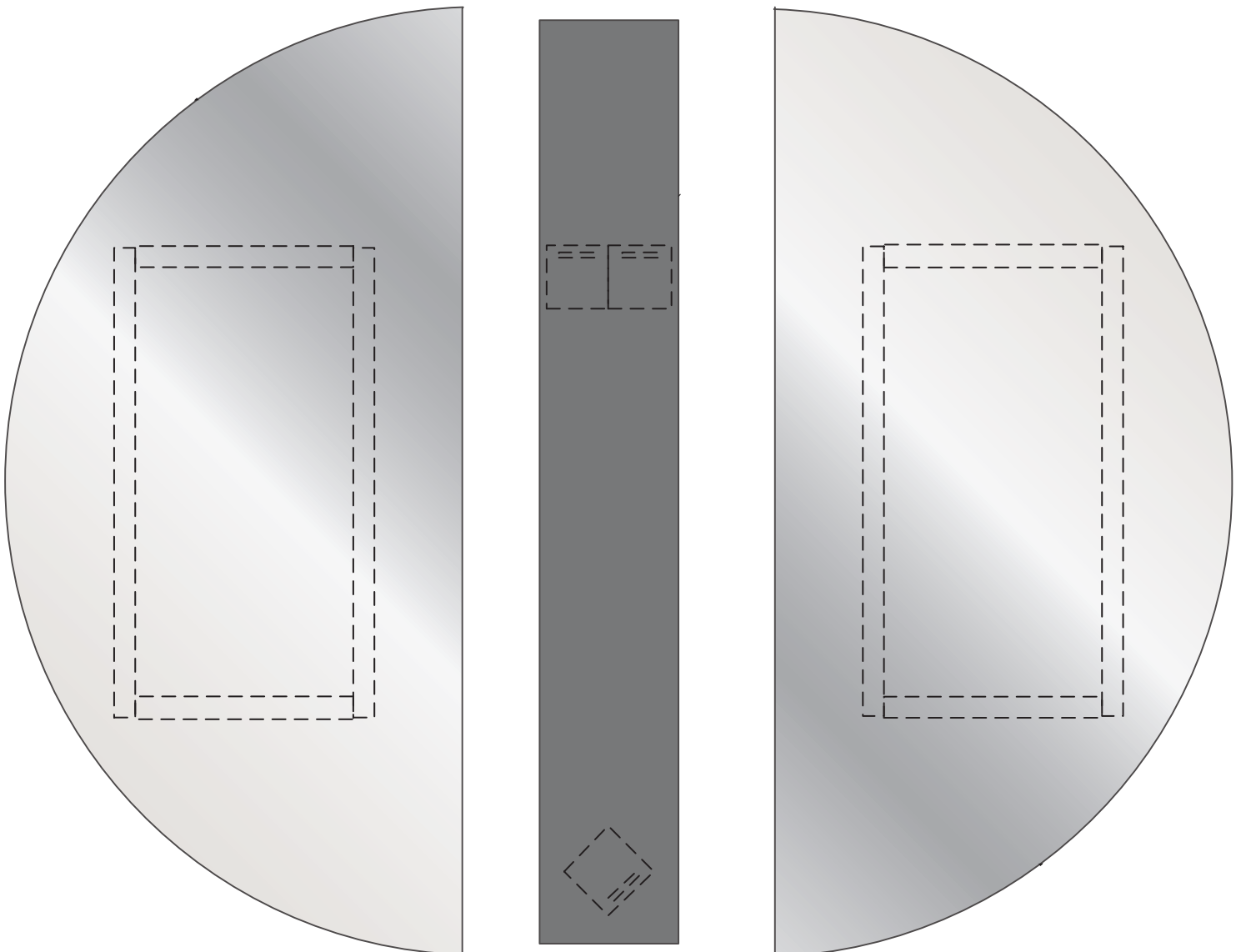
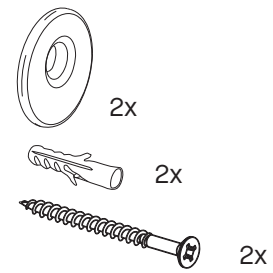
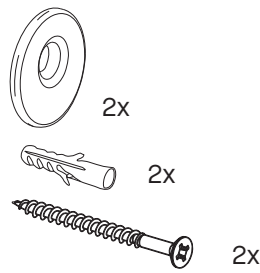
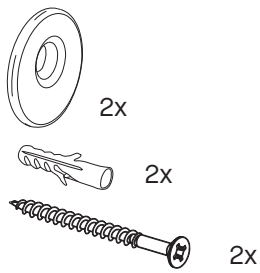

mark the suspension point on your wall  
drill holes and place the plugs, washers and screws

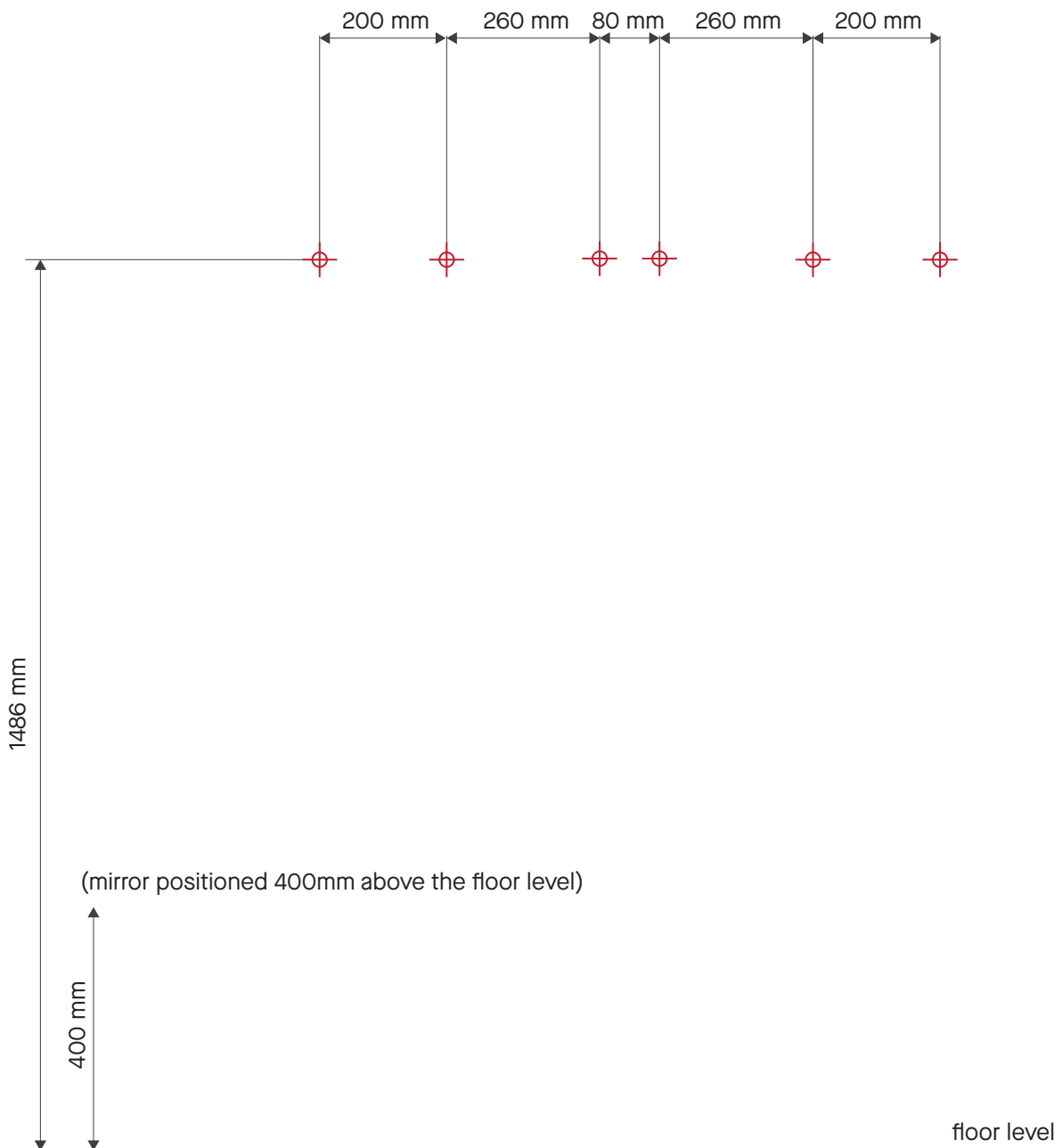
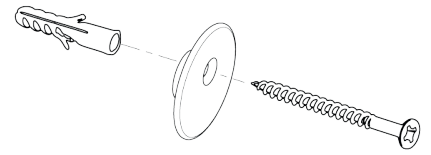

place the mirrors on the washers in the 'open' position  
once all pieces are placed on the wall slide the left and right mirror toward the central mirror  
leave a 5cm gap between the big mirrors in order to show the black mirror

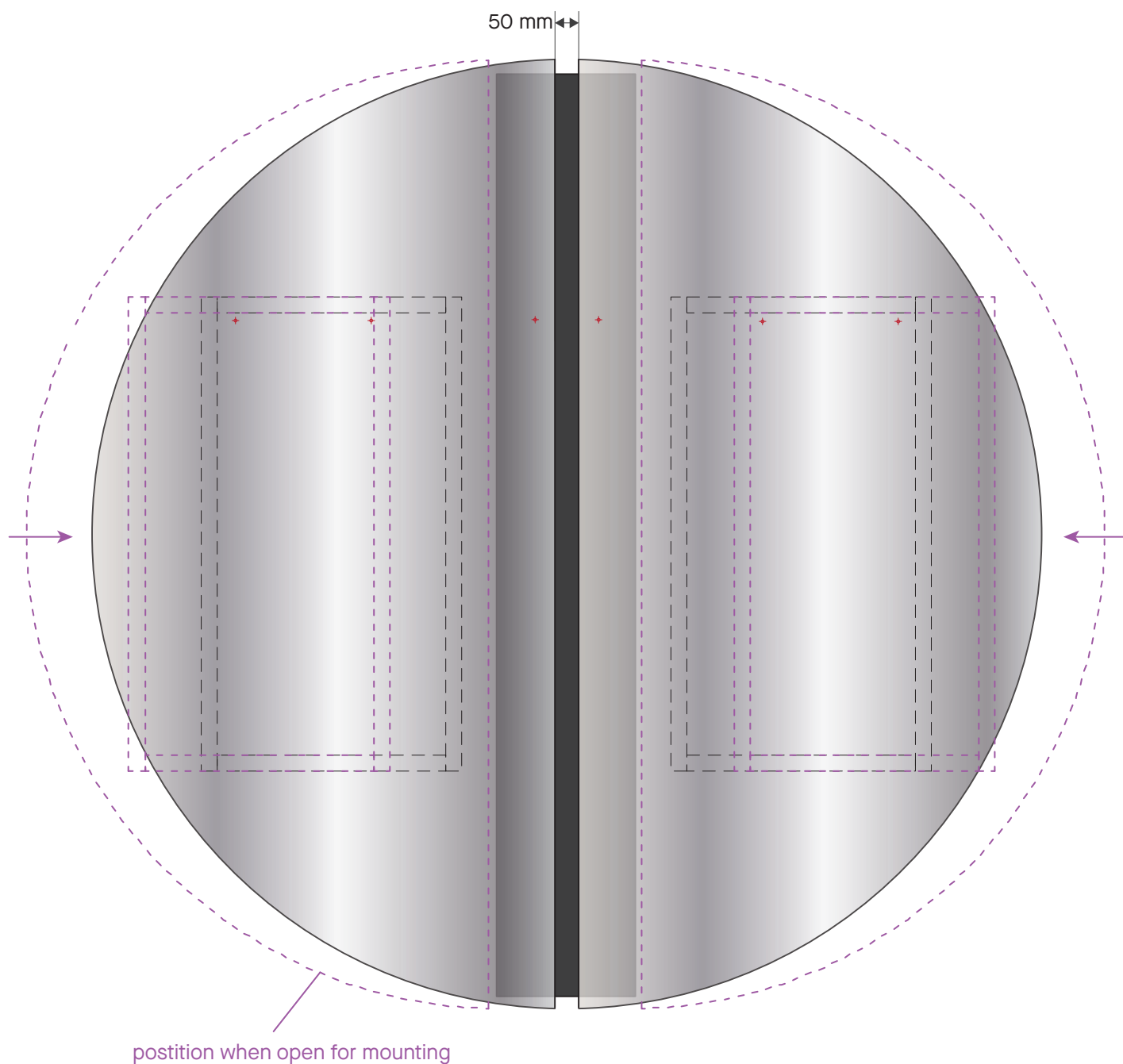

Luna Black Rect. M  
2869.250



Before mounting this mirror go to [deknudtmirrors.com](https://www.deknudtmirrors.com) | Products | Luna Black Rect. M | scroll to WATCH INSTRUCTION VIDEO

suspension accessories delivered with the mirror

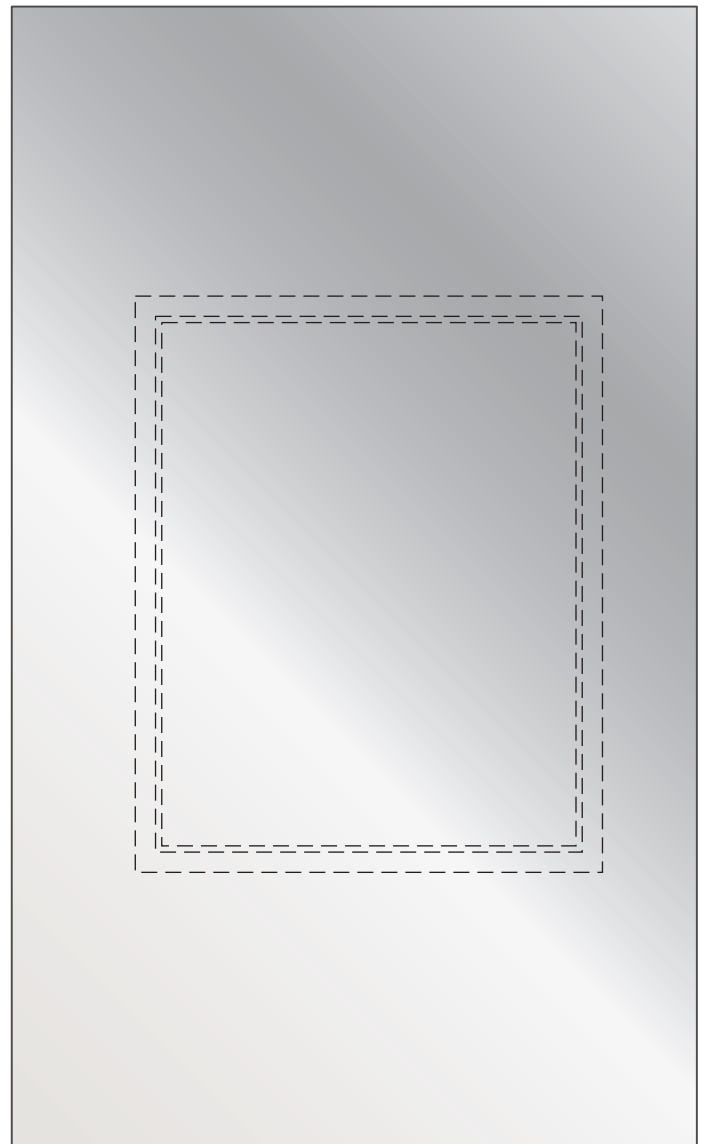
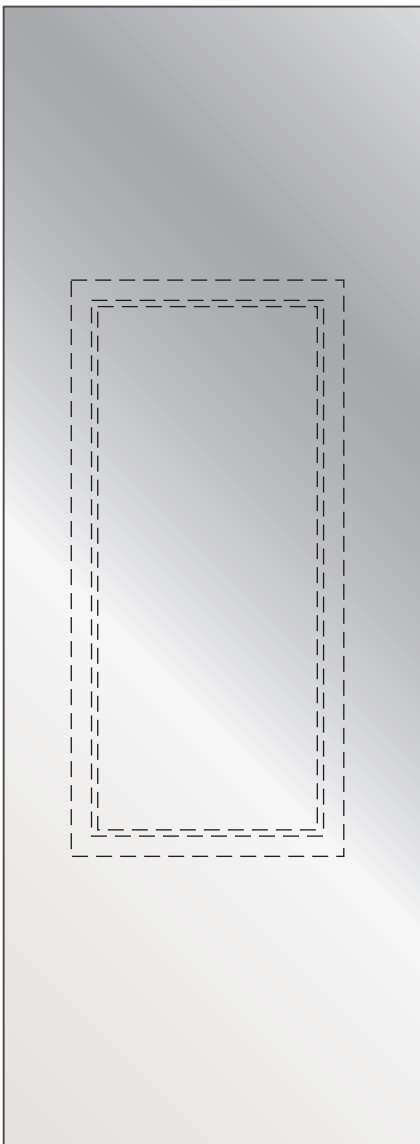
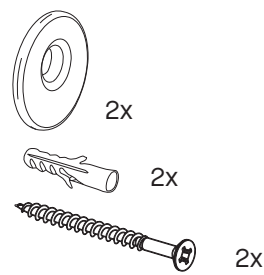
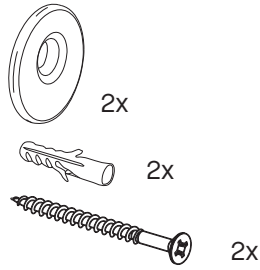
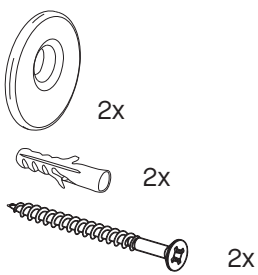

mark the suspension point on your wall  
drill holes and place the plugs, washers and screws

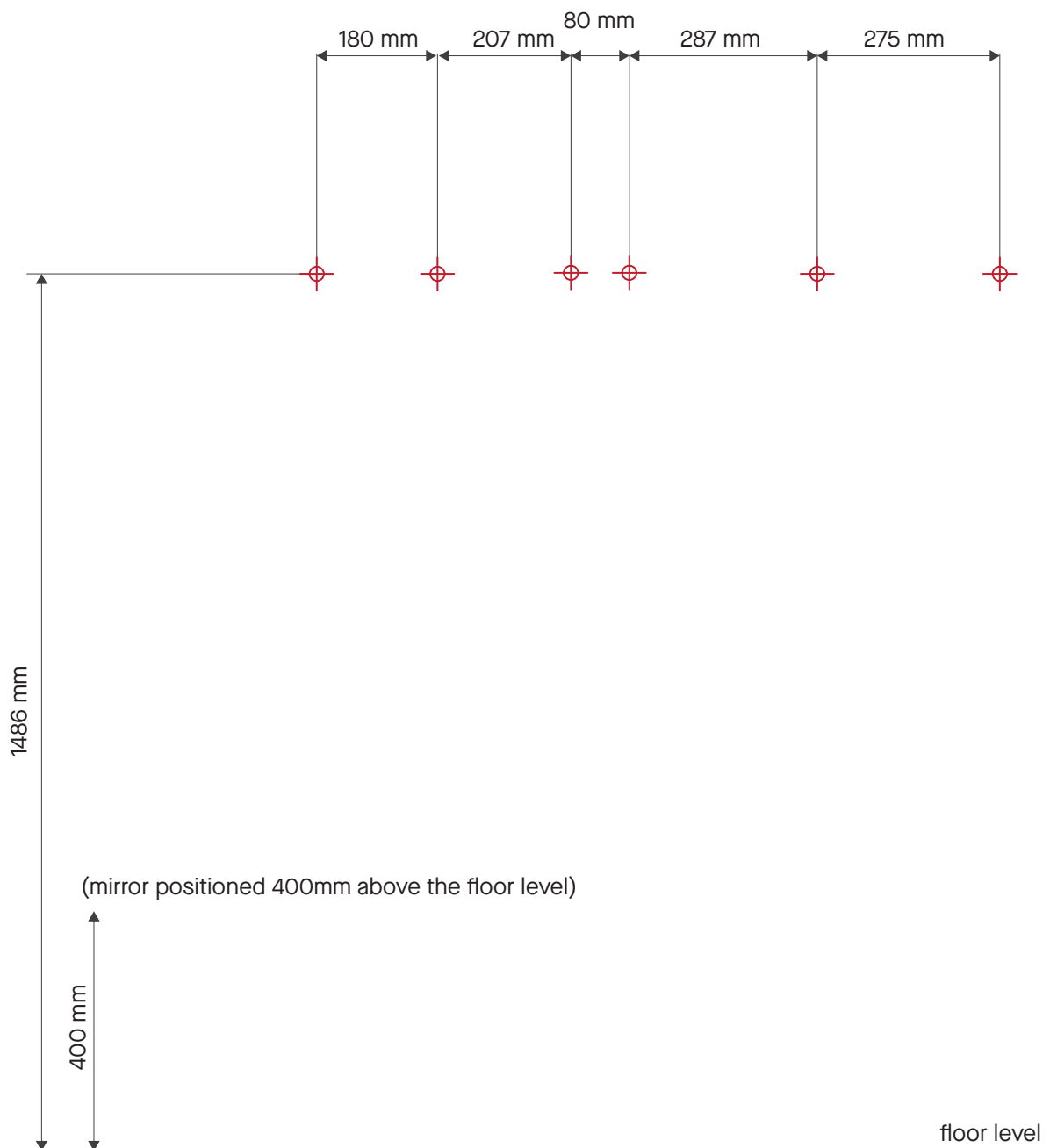
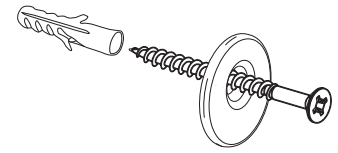

place the mirrors on the washers in the 'open' position  
once all pieces are placed on the wall slide the left and right mirror toward the central mirror  
leave a 5cm gap between the big mirrors in order to show the black mirror

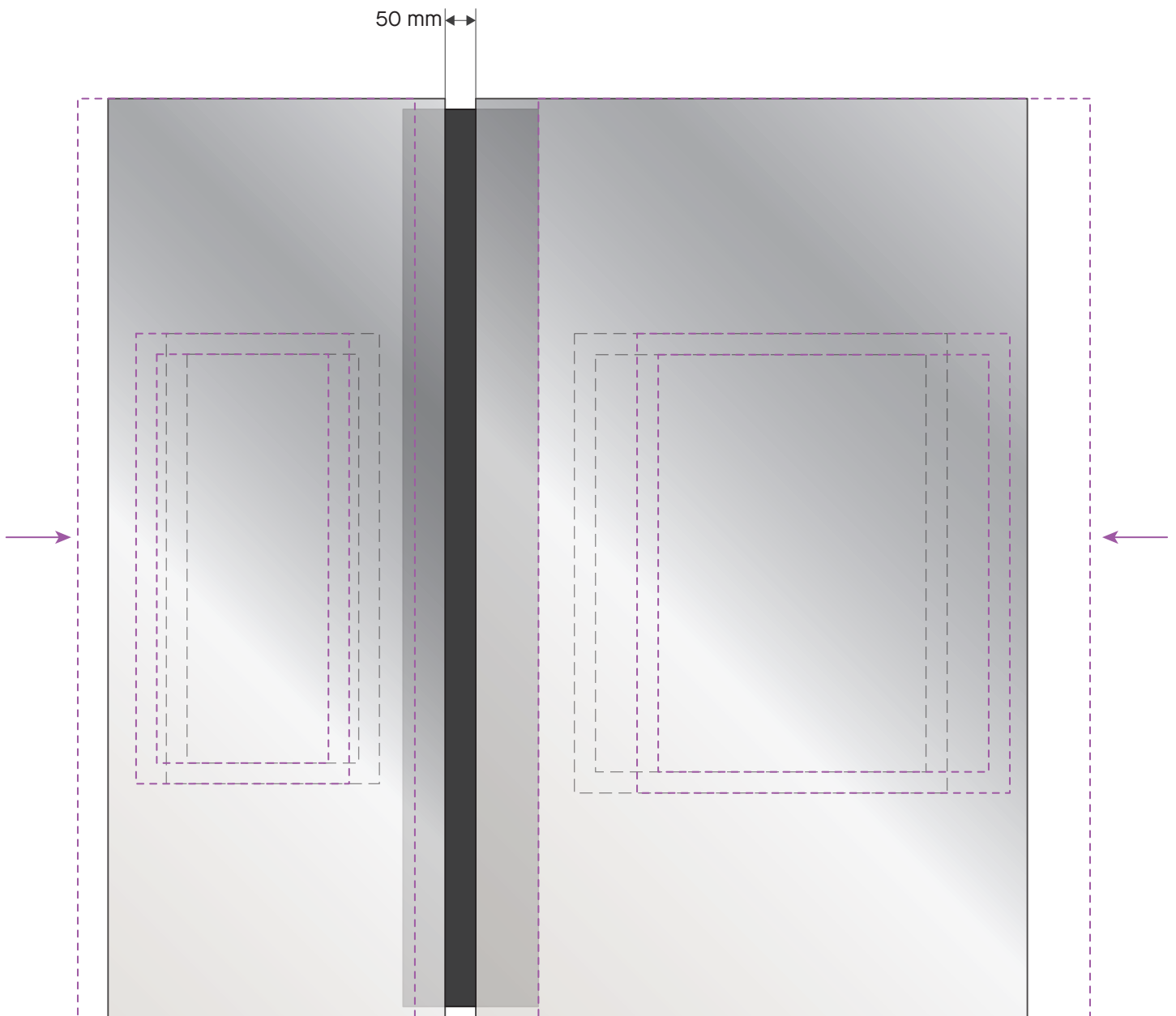

position when open for mounting