

FLOS

F011D40D055 Polished Stainless Steel

Captain Flint Outdoor B1 NEW

Designed by Michael Anastassiades

9.5W - 699lm - 4000K - CRI> 80 - Beam° 112



Integrated ON/OFF or dimmable 220-240V power supply. For mains connection, the light source is equipped with watertight cable. Box for ground or cobblestone installations requiring concrete plinth is available upon request. 2200K available on request.

Are you a professional and your project needs consulting and support?

[BOOK AN APPOINTMENT](#)

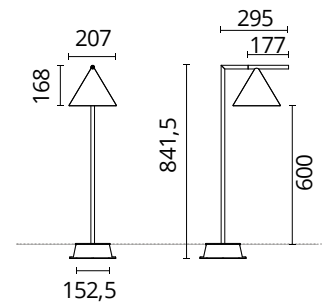

Main specifications

EAN	8059607736104
Mounting	Ground
Environments	Outdoor wet location
LED type	LED array
Number of heads	1
Power (W)	9.5
Source flux (lm)	1099
System flux (lm)	699

Physical

Colour	Polished Stainless Steel
Orientation	Adjustable
Transversal tilting (°)	270
Net weight (kg)	2.23
Package height (mm)	1080
Package width (mm)	460
Package length (mm)	320
Package volume (m3)	0.16
IP internal	65

Download

[Mounting instructions](#)  ZIP

Photometric Files

Technical Drawings

[2D](#)  ZIP

[3D](#)  ZIP

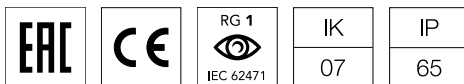

Ecodesign and Energy Labelling

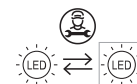

Replaceable (LED only) light source by a professional

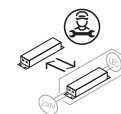

Replaceable control gear by a professional

Schematic light drawing

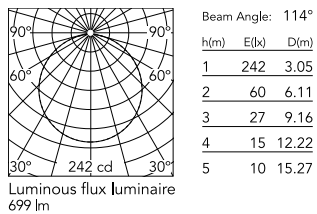

Photometric

Lighting type	Direct
Light distribution	Symmetric
CCT (K)	4000
CRI>	80
Beam angle C0-180 (°)	112
Beam angle C90-270 (°)	112

Electrical

Insulation class	II
Frequency (Hz)	50-60
Main voltage (Vac)	220-240
Driver	Remote included
Dimmable	Yes
Dimming type	Dimmable DALI 1
Dimming interface	Dimmer Integrated

Accessories & Power Supply



REQUIRED
Accessory

F018Z000000

Box for ground installation

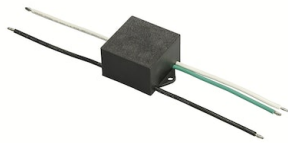

OPTIONAL
Accessory

F990E00A000

S.P.D. (SURGE PROTECTION
DEVICE)