

# SQUBE 1.0 ON 1 PHASE TRACK

20-Apr.-2019

## 1.0 LED

**LED** 6W | 220-240VAC | 50-60Hz | COB3-step | incl. PS | phase-cut dim | incl. 1-phase track adapter

CE  $\oplus$   $\wedge$  38° IP20  $\square$  960°C  $\downarrow$  0.3m  $\oplus$   $\uparrow$  90°  $\curvearrowright$  355°

white texture 144164W.  
black texture 144164B.

### LIGHT COLOUR

2700K | >80CRI | 350lm 2  
3000K | >80CRI | 380lm 4  
1800-3000K | >80CRI | 350lm 9

1-phase track accessories on second page

## 1.0 PAR16

**PAR16** max. 12W | GU10 | 100-240VAC | 50-60Hz | incl. 1-phase track adapter

CE  $\oplus$  IP20  $\square$  960°C  $\downarrow$  0.9m  $\oplus$   $\uparrow$  90°  $\curvearrowright$  355°

white texture 144120W0  
black texture 144120B0

### OPTIONAL

for PAR16 lamps see our catalogue  
1-phase track accessories on second page

④

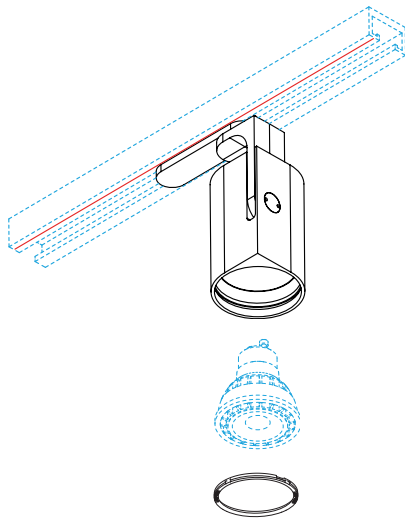

①

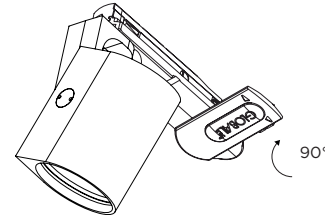

②



**SAFETY ISSUE!**  
**INSTALL THE FIXTURE**  
**CORRECTLY ON THE TRACK**  
(see remark 2)

③

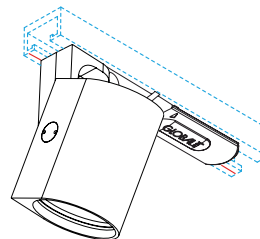

## DIMENSIONS

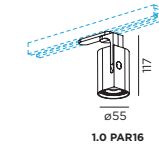
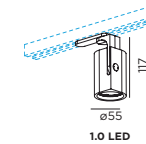

## MOUNTING INSTRUCTION

- ① Turn the handle, which is mounted on the fixture, 90°.
- ② Push the fixture into the track. Make sure the  $\oplus$  icon on the inside of the adaptor is faced towards the track side with the small line craved in it. (marked red in the drawing)



Make sure the handle is turned 90° when inserting the adapter into the track.

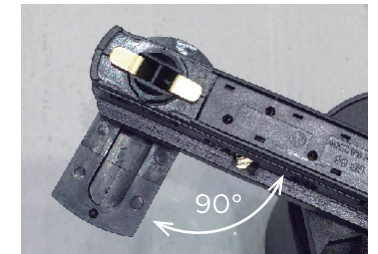

- ③ Turn the handle back into the original position.
- ④ For PAR16: mount the lamp into the fixture



**WEVER & DUCRÉ**  
LIGHTING

[www.weverducre.com](http://www.weverducre.com)

Wever & Ducre bvba Spinnerijstraat 99/21 8500 Kortrijk

**INSTALLATION  
INSTRUCTIONS**

PAGE 1/2

# SQUBE 1.0 ON 1 PHASE TRACK

ACCESSORIES

## TRACK PROFILE 1M recessed

white  
black

90014118  
90014119

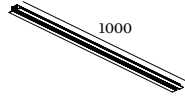
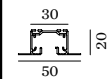

## COVERPLATE END FEEDS

white  
black

90014124  
90014125

only use with recessed tracks



## X-CONNECTOR

white  
black

90014049  
90014050

can be used as feed



## TRACK PROFILE 1M surface

white  
black

90014001  
90014007

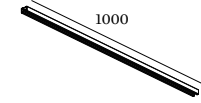

## TRACK PROFILE 2M recessed

white  
black

90014120  
90014121

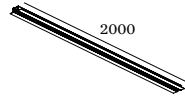
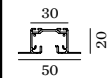

## T-CONNECTOR

white  
black

90014010  
90014011

can be used as feed



## FLEXIBLE CORNER

white  
black

90014042  
90014041



## TRACK PROFILE 2M surface

white  
black

90014002  
90014008

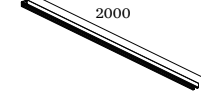

## TRACK PROFILE 3M recessed

white  
black

90014122  
90014123

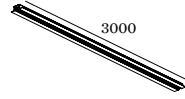
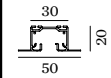

## T-CONNECTOR

white  
black

90014012  
90014013

can be used as feed



## HEIGHT ADJ. SLEEVE

90014040



## TRACK PROFILE 3M surface

white  
black

90014003  
90014009

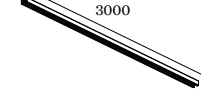

## TRACK ADAPTER

white  
black

90014044  
90014043

no space for driver  
for suspension power cable  
incl. strain relief



## T-CONNECTOR

white  
black

90014014  
90014015

can be used as feed



## SUSPENSION CLAMP

90014038



## COVERPLATE I/L/T/X

white  
black

90014126  
90014127

only use with recessed tracks

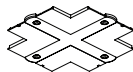

## T-CONNECTOR

white  
black

90014016  
90014017

can be used as feed



## WIRE SUSPENSION

1.5m

white 90014047  
black 90014039

3.0m

white 90014053  
black 90014082

incl. ceiling fixation  
bracket | suitable  
also for 1-phase track



WEVER & DUCRÉ  
LIGHTING

[www.weverducre.com](http://www.weverducre.com)

Wever & Ducre bvba Spinnerijstraat 99/21 8500 Kortrijk

INSTALLATION  
INSTRUCTIONS

PAGE 2/2