

Designed by Flos Outdoor

Klein Pro

ITALIANO / ENGLISH

FLOS
Outdoor

Klein Pro

Designed by Flos Outdoor







Klein Pro

Famiglia / Family

Klein Pro



Power Led

11W

294 lm - 2700K/CRI 80

304 lm - 3000K/CRI 80

325 lm - 4000K/CRI 80

Colori / Colours



01 White

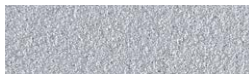

06 Grey

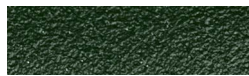

12 Forest Green



18 Deep Brown



30 Black



33 Anthracite



70 Anodized Natural



71 Anodized Black



73 Anodized Gold*

* Solo per schermo. / Only for pole screen.

Klein Pro

Descrizione / Description

Il corpo del paletto Klein Pro è stato realizzato in alluminio estruso mentre la base e il diffusore sono in alluminio pressofuso EN AB-47100 con un basso tenore di rame.

Rivestimento ad alta resistenza: il trattamento esterno viene applicato con un doppio strato di polveri epossidiche conformemente alla norma QUALICOAT. Il primo strato di polvere fornisce una resistenza chimica e meccanica; un secondo strato di finitura di polvere di poliestere garantisce la resistenza.

È disponibile anche con finitura anodizzata.

The body of Klein Pro bollard is made of extruded aluminium, base and diffuser in die-cast aluminium EN AB-47100 with a low copper content.

High-resistance coating: the external coating is applied with a double layer with epoxy powders according to the QUALICOAT standard. The first layer of epoxy powder gives chemical and mechanical resistance, the second finishing layer of polyester powder ensures resistance.

Also available in anodized finishes.

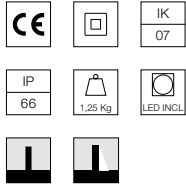
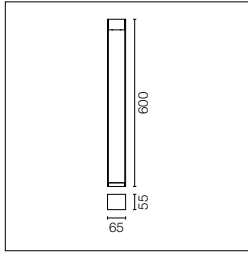

Alimentazione elettrica 220-240V integrata. Gli accessori per installazione su superficie solida o per fissaggio al terreno sono da ordinare a parte. Ogni apparecchio di illuminazione è dotato di un segmento di 1000 mm di cavo in uscita e un kit di cablaggio.

220-240V power supply integrated. Solid surface or ground installation accessories to be ordered separately. Each luminaire is equipped with 1000 mm length outgoing cable and a wiring kit.

Power Led: 11W - 1089 lm ≠ FIXT 294 lm - 2700K/CRI 80 - 220-240V / 11W - 1126 lm ≠ FIXT 304 lm - 3000K/CRI 80 - 220-240V / 11W - 1211 lm ≠ FIXT 325 lm - 4000K/CRI 80 - 220-240V

2700K

Non Dimmable

- F002A20A001.B
- F002A20A006.B
- F002A20A012.B
- F002A20A018.B
- F002A20A030.B
- F002A20A033.B
- F002A21A070.B
- F002A21A071.B

1-10V

- F002A20B001.B
- F002A20B006.B
- F002A20B012.B
- F002A20B018.B
- F002A20B030.B
- F002A20B033.B
- F002A21B070.B
- F002A21B071.B

Dali

- F002A20D001.B
- F002A20D006.B
- F002A20D012.B
- F002A20D018.B
- F002A20D030.B
- F002A20D033.B
- F002A21D070.B
- F002A21D071.B

3000K

Non Dimmable

- F002A30A001.B
- F002A30A006.B
- F002A30A012.B
- F002A30A018.B
- F002A30A030.B
- F002A30A033.B
- F002A31A070.B
- F002A31A071.B

1-10V

- F002A30B001.B
- F002A30B006.B
- F002A30B012.B
- F002A30B018.B
- F002A30B030.B
- F002A30B033.B
- F002A31B070.B
- F002A31B071.B

Dali

- F002A30D001.B
- F002A30D006.B
- F002A30D012.B
- F002A30D018.B
- F002A30D030.B
- F002A30D033.B
- F002A31D070.B
- F002A31D071.B

4000K

Non Dimmable

- F002A40A001.A
- F002A40A006.A
- F002A40A012.A
- F002A40A018.A
- F002A40A030.A
- F002A40A033.A
- F002A41A070.A
- F002A41A071.A

1-10V

- F002A40B001.A
- F002A40B006.A
- F002A40B012.A
- F002A40B018.A
- F002A40B030.A
- F002A40B033.A
- F002A41B070.A
- F002A41B071.A

Dali

- F002A40D001.A
- F002A40D006.A
- F002A40D012.A
- F002A40D018.A
- F002A40D030.A
- F002A40D033.A
- F002A41D070.A
- F002A41D071.A

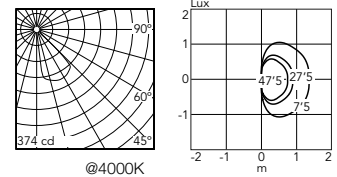

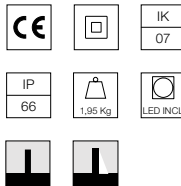
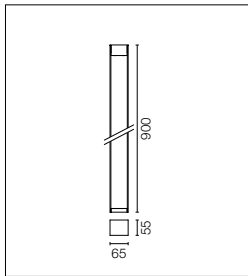

Alimentazione elettrica 220-240V integrata. Gli accessori per installazione su superficie solida o per fissaggio al terreno sono da ordinare a parte. Ogni apparecchio di illuminazione è dotato di un segmento di 1000 mm di cavo in uscita e un kit di cablaggio.

220-240V power supply integrated. Solid surface or ground installation accessories to be ordered separately. Each luminaire is equipped with 1000 mm length outgoing cable and a wiring kit.

Power Led: 11W - 1089 lm ≠ FIXT 294 lm - 2700K/CRI 80 - 220-240V / 11W - 1126 lm ≠ FIXT 304 lm - 3000K/CRI 80 - 220-240V / 11W - 1211 lm ≠ FIXT 325 lm - 4000K/CRI 80 - 220-240V

2700K

Non Dimmable

- F002B20A001.B
- F002B20A006.B
- F002B20A012.B
- F002B20A018.B
- F002B20A030.B
- F002B20A033.B
- F002B21A070.B
- F002B21A071.B

1-10V

- F002B20B001.B
- F002B20B006.B
- F002B20B012.B
- F002B20B018.B
- F002B20B030.B
- F002B20B033.B
- F002B21B070.B
- F002B21B071.B

Dali

- F002B20D001.B
- F002B20D006.B
- F002B20D012.B
- F002B20D018.B
- F002B20D030.B
- F002B20D033.B
- F002B21D070.B
- F002B21D071.B

3000K

Non Dimmable

- F002B30A001.B
- F002B30A006.B
- F002B30A012.B
- F002B30A018.B
- F002B30A030.B
- F002B30A033.B
- F002B31A070.B
- F002B31A071.B

1-10V

- F002B30B001.B
- F002B30B006.B
- F002B30B012.B
- F002B30B018.B
- F002B30B030.B
- F002B30B033.B
- F002B31B070.B
- F002B31B071.B

Dali

- F002B30D001.B
- F002B30D006.B
- F002B30D012.B
- F002B30D018.B
- F002B30D030.B
- F002B30D033.B
- F002B31D070.B
- F002B31D071.B

4000K

Non Dimmable

- F002B40A001.A
- F002B40A006.A
- F002B40A012.A
- F002B40A018.A
- F002B40A030.A
- F002B40A033.A
- F002B41A070.A
- F002B41A071.A

1-10V



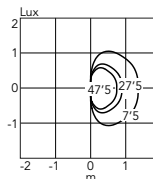
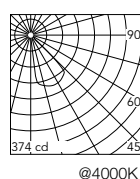

- F002B40B001.A
- F002B40B006.A
- F002B40B012.A
- F002B40B018.A
- F002B40B030.A
- F002B40B033.A
- F002B41B070.A
- F002B41B071.A

Dali

- F002B40D001.A
- F002B40D006.A
- F002B40D012.A
- F002B40D018.A
- F002B40D030.A
- F002B40D033.A
- F002B41D070.A
- F002B41D071.A

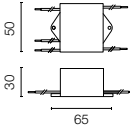

Klein Pro: Accessori / Accessories

Base di fissaggio per superfici solide.	Fixing base for solid surfaces.	<ul style="list-style-type: none"> ○ F002Z010001.A ● F002Z010006.A ● F002Z010012.A ● F002Z010018.A ● F002Z010030.A ● F002Z010033.A 	
Piastra di fissaggio a terra Minimal Klein Pro, 47x57xH160 mm.	Minimal Klein Pro ground fixation plate, 47x57xH160 mm.	F002Z030000.A	
Piastra di fissaggio a terra e tirafondi Klein Pro 85x85xH160mm.	Klein Pro base plate and fixing bolts 85x85xH160 mm.	F002Z020000	
Schermo estetico anodizzato.	Anodized aestetical pole screen.	<ul style="list-style-type: none"> H 600 mm ● F002Z040070 ● F002Z040071 ● F002Z040073 H 900 mm ● F002Z050070 ● F002Z050071 ● F002Z050073 	
Dispositivo di protezione per il sovraccarico. 240 Vac. Corrente massima di scarica 10KA (8/29us). Massima corrente operativa 5A. Adatto per la connessione in serie. IP66.	Surge protection device. 275Vac. Maximum discharge current 10KA (8/20us). Maximum operating current 5A. Suitable for series connection. IP66.	F990E00A000	 

Opzioni Montaggio / Installation Options

Option 1
Con tirafondi /
Fixing anchor bolts

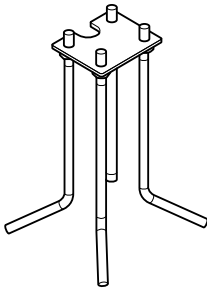
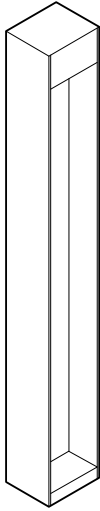

cod. F002Z030000.A

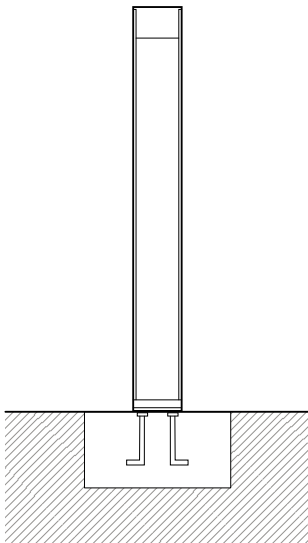

Option 2
Con base e tirafondi /
With base and fixing anchor bolts

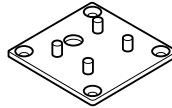
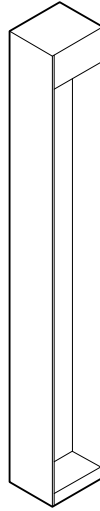

cod. F002Z0100.A

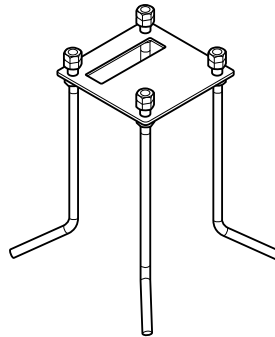

cod. F002Z020000

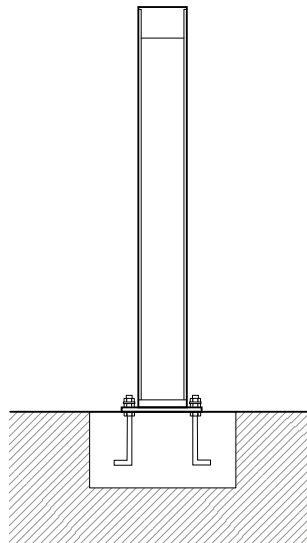

Option 3
Base per fissaggio con tasselli (non inclusi) /
With base for bolts (not included)

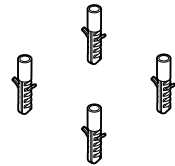
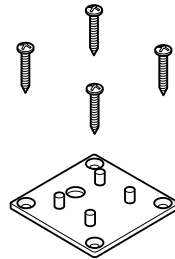

cod. F002Z0100.A

