



Designed by Piero Lissoni

Landlord

ITALIANO / ENGLISH

FLOS

Outdoor

Landlord

Designed by Piero Lissoni





Landlord Ground



Landlord Soft



Landlord Spot + Pole

Famiglia / Family

Landlord Spot



Landlord Spot + Pole



Landlord Soft



Landlord Ground



Power Led

2,3W

130 lm - 2700K/CRI 80

135 lm - 3000K/CRI 80

140 lm - 4000K/CRI 80

2200K available on request.

Power Led

3,4W

135 lm - 2700K/CRI 80

140 lm - 3000K/CRI 80

145 lm - 4000K/CRI 80

2200K available on request.

Power Led

5W

242 lm - 2700K/CRI 80

252 lm - 3000K/CRI 80

269 lm - 4000K/CRI 80

2200K available on request.

Power Led

2,3W

121 lm - 2700K/CRI 80

125 lm - 3000K/CRI 80

130 lm - 4000K/CRI 80

2200K available on request.

Power Led

7,2W

442 lm - 2700K/CRI 80

457 lm - 3000K/CRI 80

492 lm - 4000K/CRI 80

Power Led

3,4W

183 lm - 2700K/CRI 80

189 lm - 3000K/CRI 80

196 lm - 4000K/CRI 80

2200K available on request.

Colori / Colours

Landlord Spot / Soft



01 White



06 Grey



12 Forest Green



18 Deep Brown



30 Black



33 Anthracite



71 Anodized Black

Landlord Ground

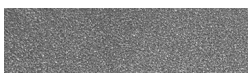

56 Matt Stainless Steel

Landlord

Landlord Spot

Proiettore IP66 per uso esterno composto da un corpo in alluminio tornito e alimentato a 24V, disponibile con temperature di colore da 2700K, 3000K e 4000K. Sull'asse orizzontale è possibile orientare il faretto di 359°, sull'asse verticale fino a 30° verso il basso e fino a 90° verso l'alto. I faretti Landlord sono disponibili in due dimensioni, con testa ø40 e ø50, entrambe dotate di ghiera anteriore smontabile, per installare lenti flood oppure fino a due honeycomb per il massimo comfort visivo.

I faretti Landlord possono essere installati su picchetti per terreni rigidi, con la possibilità di un picchetto opzionale, su base in muratura, oppure sull'innovativa cintura per alberi, progettata per fissare l'apparecchio d'illuminazione direttamente ai rami delle piante.

Landlord Soft

Proiettore IP65 per uso esterno, progettato per offrire una luce diffusa.

È caratterizzato da una testa a forma di disco in alluminio, con un fascio orientabile fino a 20° e bloccabile nella posizione desiderata; da alimentare a 24V e disponibile con temperature di colore da 2700K, 3000K e 4000K.

È lo strumento perfetto per illuminare siepi, aiuole e aree di transito con un fascio di luce diffusa omogenea.

Landlord Soft può essere installato su picchetti per terreni rigidi, con la possibilità di un picchetto opzionale.

Landlord Ground

Apparecchi d'illuminazione IP66 / IP67 da incasso a terra, alimentato a 24V. Corpo in alluminio anodizzato e poi resinato, anello esterno in acciaio inossidabile pallinato, che contiene tutta l'elettronica di controllo. Testa disponibile in due dimensioni, ø49 mm e ø64 mm, con emissione frontale o radente (uno, due o quattro fasci).

Le versioni a emissione frontale sono disponibili con ottica spot o media, o con honeycomb integrato non rimovibile, per un comfort visibile massimo.

Da installare mediante la propria scatola d'installazione.

Landlord Spot

IP66 projector for external use made of turned aluminium body and powered at 24V, and available in 2700K, 3000K and 4000K colour temperatures. With reference to the horizontal axis the spotlight can be swivelled by 359°, on the vertical axis by up to 30° down and up to 90° up.

Landlord Spots are available in two sizes, ø40 and ø50 head, both equipped with desmontable front ferrule, in order to install flood lens or up to two honeycombs for maximum visual confort.

Landlord Spots can be installed on solid ground spikes, with the possibility of an optional picket, on wall base, or on the innovative tree belt, designed to fix the luminaries directly on tree branches.

Landlord Soft

IP65 projector for external use, designed to offer diffuse lighting.

It is characterized by an aluminium disk shape head, orientable up to 20° beam and lockable in position, to be powered at 24V, and available in 2700K, 3000K and 4000K colour temperature.

It is the perfect tool to light bushes, flowerbed and transit areas with an homogenous diffuse light beam.

Landlord Soft can be installed on solid ground spikes, with the possibility of an optional picket.

Landlord Ground

IP66 / IP67 luminaries for ground recessed installation, powered 24V. Body in anodized, then resined aluminium, external ring in shot-peened stainless steel, encasing the entire control electronics. Head available in two sizes, ø49 mm, and ø64 mm, with frontal or grazing emission (one, two or four beams).

Frontal emission version are available with spot or medium optic, or with integrated non removable honeycomb, for maximum visual confort.

To be installed in its installation box.

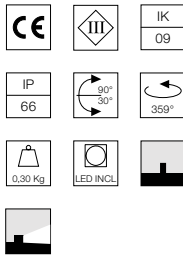
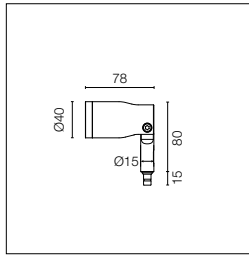

Testa del faretto orientabile per l'installazione su paletti a terra o su base in muratura. I paletti e la base devono essere ordinati come accessori separati. Le teste sono dotate di una ghiera smontabile, per inserire lenti flood o fino a due honeycomb (da ordinare come accessori separati). Alimentazione elettrica remota 24V da ordinare separatamente. Ogni testa è dotata di un segmento di cavo in uscita da 2000 mm e kit di cablaggio.

Spot adjustable head for installation on ground poles or on wall base. Poles and base to be ordered as separated accessories. Heads are equipped with a dismantlable ferrule, to insert flood lens or up to two honeycombs, (to be ordered as separate accessories). 24V remote power supply to be ordered separately. Each head comes with a 2000 mm length outgoing cable and a wiring kit.

2200K disponibile su richiesta.

2200K available on request.

Optic Spot 12°

Power Led: 2,3W - 188 lm ≠ *FIXT 130 lm - 2700K/CRI 80 - 24V / 2,3W - 195 lm ≠ *FIXT 135 lm - 3000K/CRI 80 - 24V / 2,3W - 202 lm ≠ *FIXT 140 lm - 4000K/CRI 80 - 24V

2700K

PWM Dimmable

- F004D21A001
- F004D21A006
- F004D21A012
- F004D21A018
- F004D21A030
- F004D21A033
- F004F21A071

3000K

PWM Dimmable

- F004D31A001
- F004D31A006
- F004D31A012
- F004D31A018
- F004D31A030
- F004D31A033
- F004F31A071

4000K

PWM Dimmable

- F004D41A001
- F004D41A006
- F004D41A012
- F004D41A018
- F004D41A030
- F004D41A033
- F004F41A071

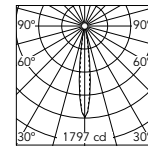

Beam Angle: 12°

h(m)	E(lx)	D(m)
1	1797	0.24
2	449	0.48
3	200	0.72
4	112	0.97
5	72	1.21

@4000K

Optic Medium 34°

Power Led: 2,3W - 188 lm ≠ *FIXT 122 lm - 2700K/CRI 80 - 24V / 2,3W - 195 lm ≠ *FIXT 127 lm - 3000K/CRI 80 - 24V / 2,3W - 202 lm ≠ *FIXT 131lm - 4000K/CRI 80 - 24V

2700K

PWM Dimmable

- F004D22A001
- F004D22A006
- F004D22A012
- F004D22A018
- F004D22A030
- F004D22A033
- F004F22A071

3000K

PWM Dimmable

- F004D32A001
- F004D32A006
- F004D32A012
- F004D32A018
- F004D32A030
- F004D32A033
- F004F32A071

4000K

- F004D42A001
- F004D42A006
- F004D42A012
- F004D42A018
- F004D42A030
- F004D42A033
- F004F42A071

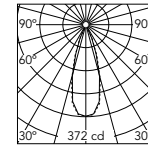

Beam Angle: 34°

h(m)	E(lx)	D(m)
1	372	0.59
2	93	1.18
3	41	1.77
4	23	2.36
5	15	2.95

@4000K

* Numero massimo di apparecchi per alimentatore / Maximum number of luminaires per power supply.

Numero massimo di apparecchi per alimentatore (Vin220÷240). Dati indicativi da verificare con le specifiche condizioni di installazione.

Maximum number of luminaires per power supply. (220÷240 V). These data must be checked taking into account the specific installation conditions.

Non Dimmable

Acc. RF25754	3
Acc. RF25748	3
Acc. RF25747	4
Acc. RF25757	4
Acc. F990B23AZ00	12
Acc. F990B28A000	17
Acc. F990B27A000	27

Dimmable

Acc. F990B02A000	13
Acc. F990B03A000	13
Acc. F990B16A000	13
Acc. F990B04A000	28
Acc. F990B05A000	28
Acc. F990B17A000	28

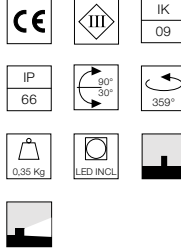
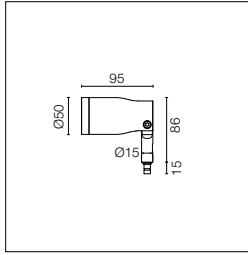

Testa del faretto orientabile per l'installazione su paletti a terra o su base in muratura. I paletti e la base devono essere ordinati come accessori separati. Le teste sono dotate di una ghiera smontabile, per inserire lenti flood o fino a due honeycomb (da ordinare come accessori separati). Alimentazione elettrica remota 24V da ordinare separatamente. Ogni testa è dotata di un segmento di cavo in uscita da 2000 mm e kit di cablaggio.

Spot adjustable head for installation on ground poles or on wall base. Poles and base to be ordered as separated accessories. Heads are equipped with a dismountable ferrule, to insert flood lens or up to two honeycombs, (to be ordered as separate accessories). 24V remote power supply to be ordered separately. Each head comes with a 2000 mm length outgoing cable and a wiring kit.

Optic Narrow Spot
2200K disponibile su richiesta.

Optic Narrow Spot
2200K available on request.

Optic Narrow Spot 7°

Power Led: 3,4W - 251 lm ≠ FIXT 135 lm - 2700K/CRI 80 - 24V / 3,4W - 260 lm ≠ FIXT 140 lm - 3000K/CRI 80 - 24V / 3,4W - 270 lm ≠ FIXT 145 lm - 4000K/CRI 80 - 24V

2700K

PWM Dimmable

- F004E21A001
- F004E21A006
- F004E21A012
- F004E21A018
- F004E21A030
- F004E21A033
- F004G21A071

3000K

PWM Dimmable

- F004E31A001
- F004E31A006
- F004E31A012
- F004E31A018
- F004E31A030
- F004E31A033
- F004G31A071

4000K

PWM Dimmable

- F004E41A001
- F004E41A006
- F004E41A012
- F004E41A018
- F004E41A030
- F004E41A033
- F004G41A071

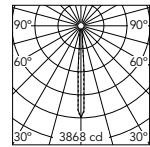

Beam Angle: 7°

h(m)	Ef(x)	D(m)
1	3868	0.14
2	967	0.28
3	430	0.41
4	242	0.55
5	155	0.69

@4000K

* Numero massimo di apparecchi per alimentatore / Maximum number of luminaires per power supply.

Numero massimo di apparecchi per alimentatore (Vin220÷240). Dati indicativi da verificare con le specifiche condizioni di installazione.

Maximum number of luminaires per power supply. (220÷240 V). These data must be checked taking into account the specific installation conditions.

Non Dimmable

Acc. RF25754	1
Acc. RF25748	1
Acc. RF25747	3
Acc. RF25757	3
Acc. F990B23AZ00	7
Acc. F990B28A000	9
Acc. F990B27A000	17

Dimmable

Acc. F990B02A000	7
Acc. F990B03A000	7
Acc. F990B16A000	7
Acc. F990B04A000	17
Acc. F990B05A000	17
Acc. F990B17A000	17

Optic Medium 24°

Power Led: 7,2W - 666 lm ≠ FIXT 442 lm - 2700K/CRI 80 - 24V / 7,2W - 689 lm ≠ FIXT 457 lm - 3000K/CRI 80 - 24V / 7,2W - 741 lm ≠ FIXT 492 lm - 4000K/CRI 80 - 24V

2700K

PWM Dimmable

- F004E22A001.A
- F004E22A006.A
- F004E22A012.A
- F004E22A018.A
- F004E22A030.A
- F004E22A033.A
- F004G22A071.A

3000K

PWM Dimmable

- F004E32A001
- F004E32A006
- F004E32A012
- F004E32A018
- F004E32A030
- F004E32A033
- F004G32A071

4000K

PWM Dimmable

- F004E42A001
- F004E42A006
- F004E42A012
- F004E42A018
- F004E42A030
- F004E42A033
- F004G42A071

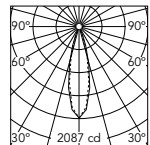

Beam Angle: 24°

h(m)	Ef(x)	D(m)
1	2087	0.47
2	522	0.94
3	232	1.41
4	130	1.88
5	83	2.35

@4000K

* Numero massimo di apparecchi per alimentatore / Maximum number of luminaires per power supply.

Numero massimo di apparecchi per alimentatore (Vin220÷240). Dati indicativi da verificare con le specifiche condizioni di installazione.

Maximum number of luminaires per power supply. (220÷240 V). These data must be checked taking into account the specific installation conditions.

Non Dimmable

Acc. RF25754	1
Acc. RF25748	1
Acc. RF25747	1
Acc. RF25757	1
Acc. F990B23AZ00	3
Acc. F990B28A000	6
Acc. F990B27A000	9

Dimmable

Acc. F990B02A000	3
Acc. F990B03A000	3
Acc. F990B16A000	3
Acc. F990B04A000	7
Acc. F990B05A000	7
Acc. F990B17A000	7

Landlord Spot: Testa + accessorio paletto / Head + pole accessory

Spot Ø40

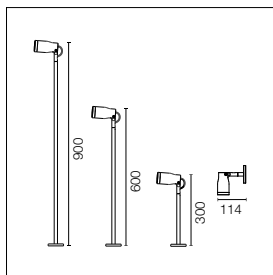

Paletto con base.
Pronta per l'installazione su superficie solida.
Per l'installazione a terra, completare con il picchetto da ordinare separatamente.

Pole with base.
Ready for installation on solid surface.
Ground installation needs earth stick use, to be ordered as separated item.

H 300 mm

- F004Z010001
- F004Z010006
- F004Z010012
- F004Z010018
- F004Z010030
- F004Z010033
- F004Z0D0071

H 600 mm

- F004Z020001
- F004Z020006
- F004Z020012
- F004Z020018
- F004Z020030
- F004Z020033
- F004Z0E0071

H 900 mm

- F004Z030001
- F004Z030006
- F004Z030012
- F004Z030018
- F004Z030030
- F004Z030033
- F004Z0F0071

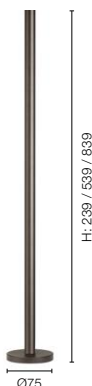

Spot Ø50

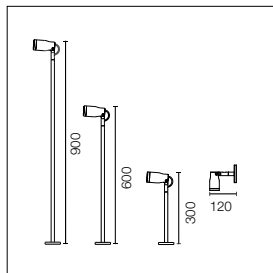

Landlord Spot: Accessori / Accessories

Base da parete.

Wall base.

- F004Z040001
- F004Z040006
- F004Z040012
- F004Z040018
- F004Z040030
- F004Z040033
- F004Z0A0071



Picchetto.
Da montare sui paletti con base.

Earth stick.
To be mounted on poles with base.

F004Z060000



Honeycomb.

Honeycomb.

Landlord Spot Ø40
F004Z0B0000
Landlord Spot Ø50
F004Z0L0000



Lente flood.

Flood lens.

Landlord Spot Ø40
F004Z0C0000
Landlord Spot Ø50
F004Z0H0000



Cinghia per alberi.
Accessorio per installazione spot direttamente sul ramo di un albero, da ø30 mm fino a ø100 mm.
Finitura Deep Brown.

Tree strap.
Accessory for spot installation directly on tree branch, from ø30mm up to ø100mm.
Deep Brown finishing.

F004Z070000



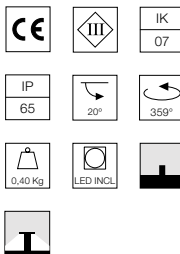
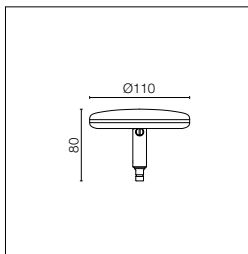

Testa orientabile a 20° per l'installazione su paletti a terra. I paletti devono essere ordinati come accessori separati. Alimentazione elettrica 24V da ordinare separatamente. Ogni testa è dotata di un segmento di cavo in uscita da 2000 mm e kit di cablaggio.

20° adjustable head for installation on ground poles. Poles to be ordered as separated accessories. 24V remote power supply to be ordered separately. Each head comes with a 2000 mm length outgoing cable and a wiring kit.

2200K disponibile su richiesta.

2200K available on request.

Top Led: 5W - 379 lm ≠ FIXT 242 lm - 2700K/CRI 80 - 24V / 5W - 395 lm ≠ FIXT 252 lm - 3000K/CRI 80 - 24V / 5W - 421 lm ≠ FIXT 269 lm - 4000K/CRI 80 - 24V

2700K

PWM Dimmable

- F004C20A001
- F004C20A006
- F004C20A012
- F004C20A018
- F004C20A030
- F004C20A033
- F004H20A071

3000K

PWM Dimmable

- F004C30A001
- F004C30A006
- F004C30A012
- F004C30A018
- F004C30A030
- F004C30A033
- F004H30A071

4000K

PWM Dimmable

- F004C40A001
- F004C40A006
- F004C40A012
- F004C40A018
- F004C40A030
- F004C40A033
- F004H40A071

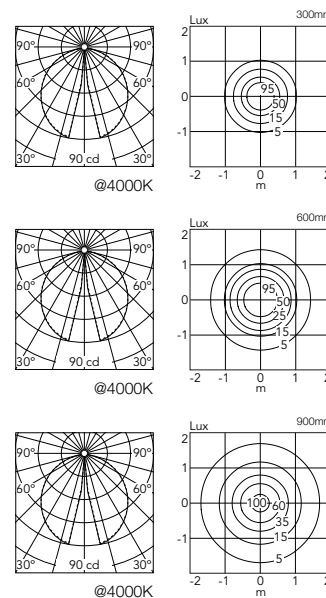

* Numero massimo di apparecchi per alimentatore / Maximum number of luminaires per power supply.

Numero massimo di apparecchi per alimentatore (Vin220÷240). Dati indicativi da verificare con le specifiche condizioni di installazione.

Maximum number of luminaires per power supply. (220÷240 V). These data must be checked taking into account the specific installation conditions.

Non Dimmable		Dimmable	
Acc. RF25754	1	Acc. RF26387.A	3
Acc. RF25748	1	Acc. F990B02A000	5
Acc. RF25747	1	Acc. F990B03A000	5
Acc. RF25757	1	Acc. F990B16A000	5
Acc. F990B23AZ00	3	Acc. F990B04A000	12
Acc. F990B28A000	6	Acc. F990B05A000	12
Acc. F990B27A000	9	Acc. F990B17A000	12

Landlord Soft: Testa + accessorio paletto / Head + pole accessory

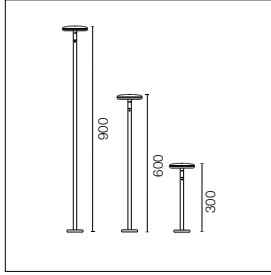

Paletto con base.
Pronta per l'installazione su
superficie solida.
Per l'installazione a terra,
completare con il picchetto da
ordinare separatamente.

Pole with base.
Ready for installation on solid surface.
Ground installation needs earth stick
use, to be ordered as separated item.



H 300 mm

- F004Z010001
- F004Z010006
- F004Z010012
- F004Z010018
- F004Z010030
- F004Z010033
- F004Z0D0071

H 600 mm

- F004Z020001
- F004Z020006
- F004Z020012
- F004Z020018
- F004Z020030
- F004Z020033
- F004Z0E0071

H 900 mm

- F004Z030001
- F004Z030006
- F004Z030012
- F004Z030018
- F004Z030030
- F004Z030033
- F004Z0F0071

Landlord Soft: Accessori / Accessories

Picchetto.
Da montare sui paletti con
base.

Earth stick.
To be mounted on poles with
base.

F004Z060000



Sistema di giunzione IP68
H2O Stop anti-condensa a
3/4 vie 4 poli. (Ø5,5÷12mm
cavo).

3/4 way terminal block 4 poles
IP68 H2O Stop. (ø5,5÷12mm
cable).

F990C010000



Sistema di giunzione IP68
H2O Stop anti-condensa a 2
vie 4 poli. (Ø5,5÷12mm cavo).

2 way terminal block 4 poles
IP68 H2O Stop. (ø5,5÷12mm
cable).

F990C00A000

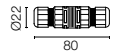

Alimentatore per installazione
remota 24Vdc 20W / 110-
240Vdc (15W@110V) IP67
Classe II selv.

Power supply for remote
installation 24Vdc 20W / 110-
240Vdc (15W@110V) IP67
Class II selv.

Landlord Soft
Only for Dali version
RF26387.A
Dimmable DALI



190

Esempi di Configurazione / Examples of Configuration

ON-OFF (non dimmerabile) = codice prodotto (F004C30A001 + F004Z010001) + alimentatore 8W / 110-240Vac / 24Vdc ON-OFF IP65 (RF25748)

ON-OFF (non dimmable) = luminaire code (F004C30A001 + F004Z010001) + power supply 8W / 110-240Vac / 24Vdc ON-OFF IP65 (RF25748)

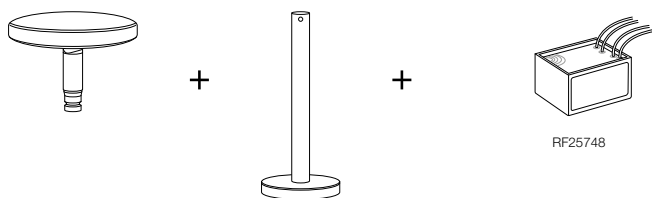

Dimmerabile 1-10V = codice prodotto (F004C30A001 + F004Z010001) + alimentatore 35W / 120-270Vac / 24Vdc 1-10V PWM control IP67 (F990B02A000)

Dimmable 1-10V = luminaire code (F004C30A001 + F004Z010001) + power supply 35W / 120-270Vac / 24Vdc 1-10V PWM control IP67 (F990B02A000)

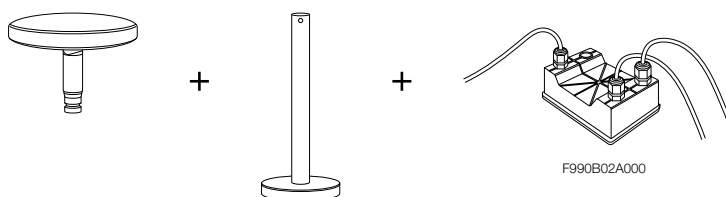

Dimmerabile 1-10V: interfaccia PWM + alimentatore = codice prodotto (F004C30A001 + F004Z010001) + interfaccia di controllo 1-10V PWM 24Vdc 120W IP67 (F990B00A000) + alimentatore 8W / 110-240Vac / 24Vdc ON-OFF IP65 (RF25748) o altro alimentatore remoto 24Vdc

Dimmable 1-10V : PWM control interface + power supply = luminaire code (F004C30A001 + F004Z010001) + PWM control interface 1-10V PWM 24Vdc 120W IP67 (F990B00A000) + power supply 8W / 110-240Vac / 24Vdc ON-OFF IP65 (RF25748) or other remote power supply

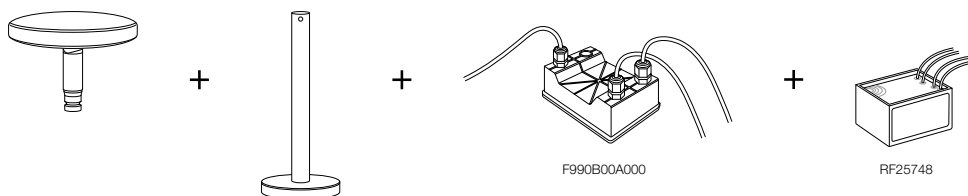

Dimmerabile DALI = codice prodotto (F004C30A001 + F004Z010001) + alimentatore 35W / 120-270Vac / 24Vdc DALI PWM control IP67 (F990B03A000)

Dimmable DALI = luminaire code (F004C30A001 + F004Z010001) + power supply 35W / 120-270Vac / 24Vdc DALI PWM control IP67 (F990B03A000)

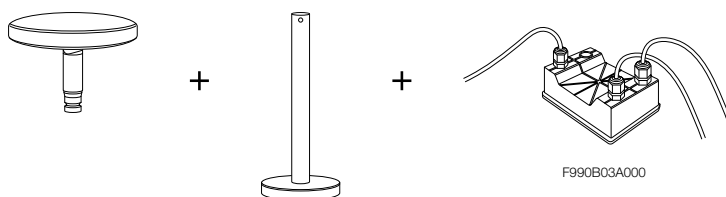

Dimmerabile DALI: interfaccia PWM + alimentatore = codice prodotto (F004C30A001 + F004Z010001) + interfaccia di controllo DALI PWM 24Vdc 120W IP67 (F990B01A000) + alimentatore 8W / 110-240Vac / 24Vdc ON-OFF IP65 (RF25748) o altro alimentatore remoto 24Vdc

Dimmable DALI: PWM control interface + power supply = luminaire code (F004C30A001 + F004Z010001) + PWM control interface DALI PWM 24Vdc 120W IP67 (F990B01A000) + power supply 8W / 110-240Vac / 24Vdc ON-OFF IP65 (RF25748) or other remote power supply

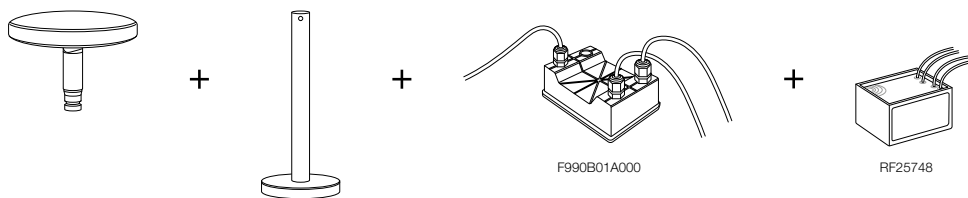

Landlord Ground 49

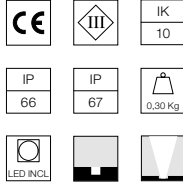
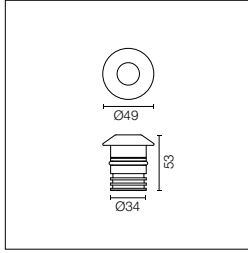

Alimentazione elettrica remota 24V da ordinare separatamente. Necessaria cassaforma per installazione, da ordinare separatamente.

24V remote power supply to be ordered separately. Necessary box for installation, to be ordered separately.

2200K disponibile su richiesta.

2200K available on request.

Power Led: 2,3W - 188 lm ≠ *FIXT 121 lm - 2700K/CRI 80 - 24V / 2,3W - 195 lm ≠ *FIXT 125 lm - 3000K/CRI 80 - 24V / 2,3W - 202 lm ≠ *FIXT 130 lm - 4000K/CRI 80 - 24V
*FIXT lm = Spot Optic

Optic Spot 14°

2700K

Non Dimmable

① F004A21A056

PWM Dimmable

① F004A21H056

Non Dimmable with honeycomb

① F004A26A05601

3000K

Non Dimmable

① F004A31A056

PWM Dimmable

① F004A31H056

Non Dimmable with honeycomb

① F004A36A05601

4000K

Non Dimmable

① F004A41A056

PWM Dimmable

① F004A41H056

Non Dimmable with honeycomb

① F004A46A05601

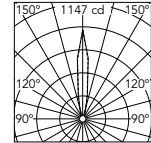

Beam Angle: 14°

h(m)	E(lx)	D(m)
1	1147	0.26
2	287	0.51
3	127	0.77
4	72	1.02
5	46	1.28

@4000K

Optic Medium 40°

2700K

Non Dimmable

① F004A22A056

PWM Dimmable

① F004A22H056

Non Dimmable with honeycomb

① F004A27A05602

3000K

Non Dimmable

① F004A32A056

PWM Dimmable

① F004A32H056

Non Dimmable with honeycomb

① F004A37A05602

4000K

Non Dimmable

① F004A42A056

PWM Dimmable

① F004A42H056

Non Dimmable with honeycomb

① F004A47A05602

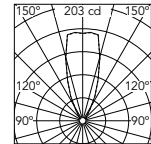

Beam Angle: 40°

h(m)	E(lx)	D(m)
1	203	0.72
2	51	1.44
3	23	2.16
4	13	2.88
5	8	3.61

@4000K

Landlord Ground 49 1 Beam

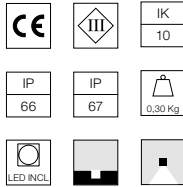
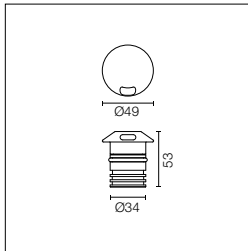

Alimentazione elettrica remota 24V da ordinare separatamente. Necessaria cassaforma per installazione, da ordinare separatamente.

24V remote power supply to be ordered separately. Necessary box for installation, to be ordered separately.

2200K disponibile su richiesta.

2200K available on request.

Power Led: 2,3W - 188 lm ≠ FIXT 8 lm - 2700K/CRI 80 - 24V / 2,3W - 195 lm ≠ FIXT 9 lm - 3000K/CRI 80 - 24V / 2,3W - 202 lm ≠ FIXT 9 lm - 4000K/CRI 80 - 24V

2700K

Non Dimmable

① F004A23A056

PWM Dimmable

① F004A23H056

3000K

Non Dimmable

① F004A33A056

PWM Dimmable

① F004A33H056

4000K

Non Dimmable

① F004A43A056

PWM Dimmable

① F004A43H056

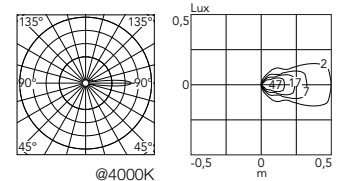

@4000K

Landlord Ground 49 2 Beams

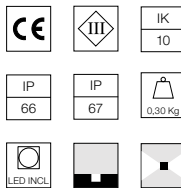
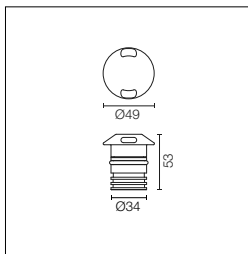

Alimentazione elettrica remota 24V da ordinare separatamente. Necessaria cassaforma per installazione, da ordinare separatamente.

24V remote power supply to be ordered separately. Necessary box for installation, to be ordered separately.

2200K disponibile su richiesta.

2200K available on request.

Power Led: 2,3W - 188 lm ≠ FIXT 16 lm - 2700K/CRI 80 - 24V / 2,3W - 195 lm ≠ FIXT 17 lm - 3000K/CRI 80 - 24V / 2,3W - 202 lm ≠ FIXT 18 lm - 4000K/CRI 80 - 24V

2700K

Non Dimmable

- ① F004A24A056
- PWM Dimmable
- ① F004A24H056

3000K

Non Dimmable

- ① F004A34A056
- PWM Dimmable
- ① F004A34H056

4000K

Non Dimmable

- ① F004A44A056
- PWM Dimmable
- ① F004A44H056

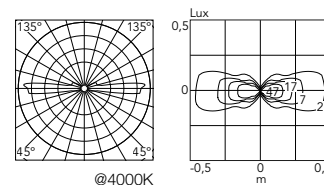

Landlord Ground 49 4 Beams

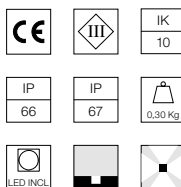
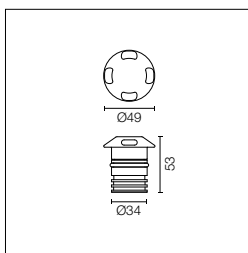

Alimentazione elettrica remota 24V da ordinare separatamente. Necessaria cassaforma per installazione, da ordinare separatamente.

24V remote power supply to be ordered separately. Necessary box for installation, to be ordered separately.

2200K disponibile su richiesta.

2200K available on request.

Power Led: 2,3W - 188 lm ≠ FIXT 32 lm - 2700K/CRI 80 - 24V / 2,3W - 195 lm ≠ FIXT 34 lm - 3000K/CRI 80 - 24V / 2,3W - 202 lm ≠ FIXT 36 lm - 4000K/CRI 80 - 24V

2700K

Non Dimmable

- ① F004A25A056
- PWM Dimmable
- ① F004A25H056

3000K

Non Dimmable

- ① F004A35A056
- PWM Dimmable
- ① F004A35H056

4000K

Non Dimmable

- ① F004A45A056
- PWM Dimmable
- ① F004A45H056

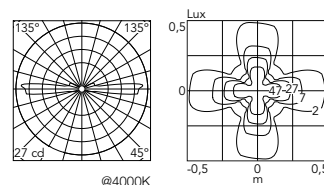

* Numero massimo di apparecchi per alimentatore / Maximum number of luminaires per power supply.

Numero massimo di apparecchi per alimentatore (Vin220÷240). Dati indicativi da verificare con le specifiche condizioni di installazione.

Maximum number of luminaires per power supply. (220÷240 V). These data must be checked taking into account the specific installation conditions.

Non Dimmable		Dimmable	
Acc. RF25754	2	Acc. F990B02A000	13
Acc. RF25748	2	Acc. F990B03A000	13
Acc. RF25747	3	Acc. F990B16A000	13
Acc. RF25757	3	Acc. F990B04A000	28
Acc. F990B23AZ00	9	Acc. F990B05A000	28
Acc. F990B28A000	14	Acc. F990B17A000	28
Acc. F990B27A000	29		

Landlord Ground Ø49: Accessori / Accessories

Cassaforma.

Box for installation.

F004Z0J0000

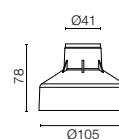

Landlord Ground 64

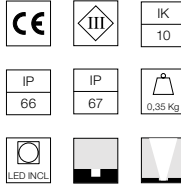
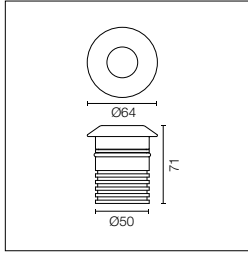

Alimentazione elettrica remota 24V da ordinare separatamente. Necessaria cassaforma per installazione, da ordinare separatamente.

24V remote power supply to be ordered separately. Necessary box for installation, to be ordered separately.

2200K disponibile su richiesta.

2200K available on request.

Power Led: 3,4W - 251 lm ≠ *FIXT 183 lm - 2700K/CRI 80 - 24V / 3,4W - 260 lm ≠ *FIXT 189 lm - 3000K/CRI 80 - 24V / 3,4W - 270 lm ≠ *FIXT 196 lm - 4000K/CRI 80 - 24V
*FIXT lm = Spot Optic

Optic Spot 15°

2700K

Non Dimmable

① F004B21A056

PWM Dimmable

① F004B21H056

Non Dimmable with honeycomb

① F004B26A05601

3000K

Non Dimmable

① F004B31A056

PWM Dimmable

① F004B31H056

Non Dimmable with honeycomb

① F004B36A05601

4000K

Non Dimmable

① F004B41A056

PWM Dimmable

① F004B41H056

Non Dimmable with honeycomb

① F004B46A05601

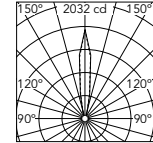

Beam Angle: 15°

h(m)	E(lx)	D(m)
1	2032	0.27
2	508	0.53
3	226	0.80
4	127	1.06
5	81	1.33

@4000K

Optic Medium 25°

2700K

Non Dimmable

① F004B22A056

PWM Dimmable

① F004B22H056

Non Dimmable with honeycomb

① F004B27A05602

3000K

Non Dimmable

① F004B32A056

PWM Dimmable

① F004B32H056

Non Dimmable with honeycomb

① F004B37A05602

4000K

Non Dimmable

① F004B42A056

PWM Dimmable

① F004B42H056

Non Dimmable with honeycomb

① F004B47A05602

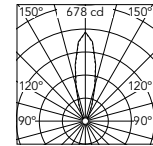

Beam Angle: 25°

h(m)	E(lx)	D(m)
1	678	0.46
2	169	0.92
3	75	1.38
4	42	1.84
5	27	2.30

@4000K

Landlord Ground 64 1 Beam

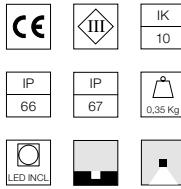
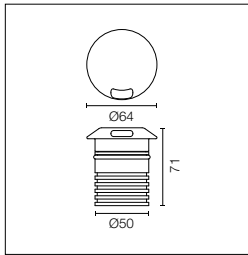

Alimentazione elettrica remota 24V da ordinare separatamente. Necessaria cassaforma per installazione, da ordinare separatamente.

24V remote power supply to be ordered separately. Necessary box for installation, to be ordered separately.

2200K disponibile su richiesta.

2200K available on request.

Power Led: 3,4W - 251 lm ≠ FIXT 11 lm - 2700K/CRI 80 - 24V / 3,4W - 260 lm ≠ FIXT 12 lm - 3000K/CRI 80 - 24V / 3,4W - 270 lm ≠ FIXT 12 lm - 4000K/CRI 80 - 24V

2700K

Non Dimmable

① F004B23A056

PWM Dimmable

① F004B23H056

3000K

Non Dimmable

① F004B33A056

PWM Dimmable

① F004B33H056

4000K

Non Dimmable

① F004B43A056

PWM Dimmable

① F004B43H056

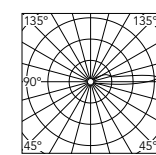

@4000K

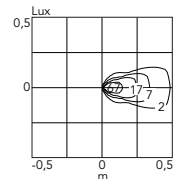

Landlord Ground 64 2 Beams

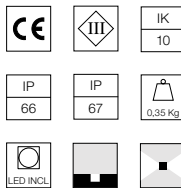
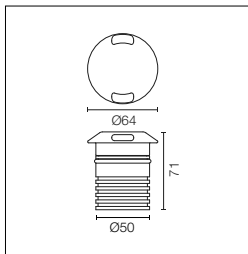

Alimentazione elettrica remota
24V da ordinare separatamente.
Necessaria cassaforma per
installazione, da ordinare
separatamente.

24V remote power supply to be
ordered separately.
Necessary box for installation,
to be ordered separately.

2200K disponibile su richiesta.

2200K available on request.

Power Led: 3,4W - 251 lm ≠ FIXT 22 lm - 2700K/CRI 80 - 24V / 3,4W - 260 lm ≠ FIXT 23 lm - 3000K/CRI 80 - 24V / 3,4W - 270 lm ≠ FIXT 24 lm - 4000K/CRI 80 - 24V

2700K

Non Dimmable

- F004B24A056
- PWM Dimmable
- F004B24H056

3000K

Non Dimmable

- F004B34A056
- PWM Dimmable
- F004B34H056

4000K

Non Dimmable

- F004B44A056
- PWM Dimmable
- F004B44H056

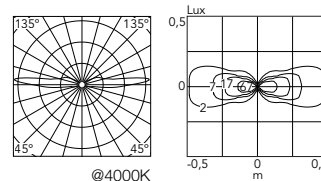

Landlord Ground 64 4 Beams

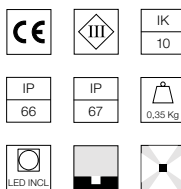
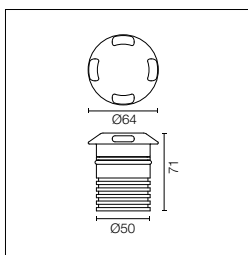

Alimentazione elettrica remota
24V da ordinare separatamente.
Necessaria cassaforma per
installazione, da ordinare
separatamente.

24V remote power supply to be
ordered separately.
Necessary box for installation, to
be ordered separately.

2200K disponibile su richiesta.

2200K available on request.

Power Led: 3,4W - 251 lm ≠ FIXT 44 lm - 2700K/CRI 80 - 24V / 3,4W - 260 lm ≠ FIXT 46 lm - 3000K/CRI 80 - 24V / 3,4W - 270 lm ≠ FIXT 48 lm - 4000K/CRI 80 - 24V

2700K

Non Dimmable

- F004B25A056
- PWM Dimmable
- F004B25H056

3000K

Non Dimmable

- F004B35A056
- PWM Dimmable
- F004B35H056

4000K

Non Dimmable

- F004B45A056
- PWM Dimmable
- F004B45H056

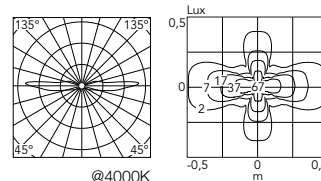

* Numero massimo di apparecchi per alimentatore / Maximum number of luminaires per power supply.

Numero massimo di apparecchi per alimentatore (Vin220÷240). Dati indicativi da verificare con le specifiche condizioni di installazione.

Maximum number of luminaires per power supply. (220÷240 V). These data must be checked taking into account the specific installation conditions.

Non Dimmable		Dimmable	
Acc. RF25754	1	Acc. F990B02A000	7
Acc. RF25748	1	Acc. F990B03A000	7
Acc. RF25747	3	Acc. F990B16A000	7
Acc. RF25757	3	Acc. F990B04A000	17
Acc. F990B23AZ00	7	Acc. F990B05A000	17
Acc. F990B28A000	9	Acc. F990B17A000	17
Acc. F990B27A000	17		

Landlord Ground Ø64: Accessori / Accessories

Cassaforma.

Box for installation.

F004Z0K0000

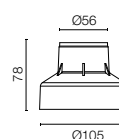

Landlord: Accessori / Accessories

Sistema di giunzione IP68 a 2 vie 2 poli. (Ø4÷6,9mm cavo).
2 way terminal block 2 poles IP68. (Ø4÷6,9mm cable).

F990C050000

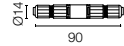

Non può essere alloggiato nella scatola per incasso.

It can't be placed in the recessed box for installation.

Landlord (all versions): Power Supply Dimmable

Alimentatore 24V PWM con interfaccia di controllo 1-10V IP67 Classe II. Vin 120-270 Vac.

Power supply 24V PWM with 1-10V control interface IP67 Class II. Vin 120-270 Vac.

35W
*F990B02A000
70W
*F990B04A000

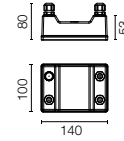

Alimentatore 24V PWM con interfaccia di controllo DALI IP67 Classe II. Vin 120-270 Vac.

Power supply 24V PWM with DALI control interface IP67 Class II. Vin 120-270 Vac.

35W
*F990B03A000
70W
*F990B05A000

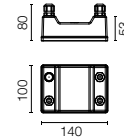
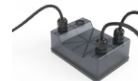

Alimentatore 24V PWM con interfaccia di controllo PUSH IP67 Classe II. Vin 120-270 Vac.

Power supply 24V PWM with PUSH control interface IP67 Class II. Vin 120-270 Vac.

35W
*F990B16A000
70W
*F990B17A000

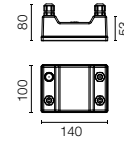
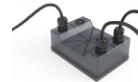

Interfaccia di controllo 24V PWM - 1-10V IP67 Class III. Vin 24Vdc 120W (Fonte di alimentazione non inclusa).

Control interface 24V PWM - 1-10V IP67 Class III. Vin 24Vdc 120W (Power supply not included).

F990B00A000

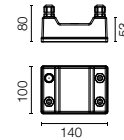
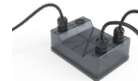

Interfaccia di controllo 24V PWM - Dali IP67 Class III. Vin 24Vdc 120W (Fonte di alimentazione non inclusa).

Control interface 24V PWM - Dali IP67 Class III. Vin 24Vdc 120W (Power supply not included).

F990B01A000

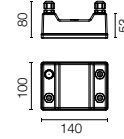
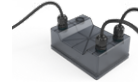

Interfaccia di controllo 24V PWM - Push IP67 Class III. Vin 24Vdc 120W (Fonte di alimentazione non inclusa).

Control interface 24V PWM - Push IP67 Class III. Vin 24Vdc 120W (Power supply not included).

F990B18A000

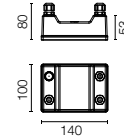
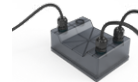

Landlord: Power Supply Non Dimmable

Alimentatore doppia funzione 24V / 350mA IP20 Classe II selv. no dimmerabile.	Power supply dual function 24V / 350mA IP20 Class II selv no dimmable.	*RF25754		
Alimentatore doppia funzione 24V / Iout 350mA 110-240V IP65.	Power supply dual function 24V / Iout 350mA 110-240V IP65.	*RF25748		
Alimentatore 24V 10W / 110- 240V IP20 Classe II selv.	Power supply 24V 10W /110- 240V IP20 Class II selv.	*RF25747		
Alimentatore 24V 10W / 110- 240V IP67 Classe II selv.	Power supply 24V 10W / 110-240V IP67 Class II selv.	*RF25757		
Alimentatore 24Vdc 35W / 120-270V IP67 Classe II selv.	Power supply 24Vdc 35W / 120-270V IP67 Class II selv.	F990B23AZ00		
Alimentatore 24Vdc 50W / 120-240V IP67 Classe II selv.	Power supply 24Vdc 50W / 120-240V IP67 Class II selv.	*F990B28A000		
Alimentatore 24Vdc 70W / 220-240V IP67 Classe II selv.	Power supply 24Vdc 70W / 220-240V IP67 Class II selv.	*F990B27A000		

