



Designed by Piero Lissoni

# Real Matter

ITALIANO / ENGLISH

FLOS  
Outdoor

**Real Matter**

Designed by Piero Lissoni





Real Matter



## Famiglia / Family

---

Real Matter



### Low - Power Led

3W

71 lm - 2700K/CRI 80

82 lm - 3000K/CRI 80

2200K available on request.

## Colori / Colours

---



44 Brushed Gold



47 Brushed Bronze



55 Brushed Stainless  
Steel



66 Polished Copper

Real Matter

## Descrizione / Description

---

Apparecchio da esterni per installazione a incasso a parete con fonte di luce a LED.

Corpo in acciaio inox AISI 316L trattato con processo PVD (Physical Vapour Deposition). Grazie a questo innovativo trattamento, dopo il processo di lucidatura o spazzolatura secondo la finitura scelta, le superfici del Real Matter sono ricoperte da un sottile film di metalli come zirconio e titanio che, combinandosi con l'acciaio a livello molecolare, ne aumentano le caratteristiche di resistenza sia meccanica che agli agenti atmosferici, permettendo la realizzazione di finiture pregiate e durevoli.

Diffusore in policarbonato stabilizzato ai raggi UV.

L'apparecchio è fornito con due cavi di alimentazione uscenti L 200mm e con un kit per la connessione a tenuta IP. È necessario utilizzare una cassaforma, da ordinare separatamente.

L'alimentatore elettrico a 24V può essere installato in remoto o alloggiato posteriormente all'apparecchio nella cassaforma.

Prodotto in 3 differenti versioni in base alla modalità di installazione:

- in muratura o in cemento con apposita cassaforma da incasso.
- in parete di cartongesso con apposite molle.
- in muratura o in cemento senza cassaforma da incasso: l'apparecchio viene incollato direttamente sulla superficie.

Luminaire for outdoor use for built-in installation on the wall with LED light source.

Body made of stainless steel AISI 316L treated with the PVD process (Physical Vapour Deposition). Thanks to this innovative treatment, after the polishing or brushing process, according to the finishing choice, the surfaces of Real Matter are coated with a thin film of metals such as zirconium and titanium which, combining with the steel at the molecular level, increase the characteristics of resistance to both mechanical and to atmospheric agents, allowing the realization of elegant and durable finishings.

UV-stabilized polycarbonate diffuser.

The luminaire is provided with two L 200 mm length outgoing power cables and with a kit for the hermetic IP connection. It is necessary to use an installation box, to be ordered separately.

24V power supply may be installed remotely or housed at the back of the luminaire in the box for installation.

3 version available select the model suitable for your type of installation:

- in concrete surface with recessed box to.
- in plasterboard surface supplied with springs.
- on solid surface no recessed box needed, the fixtures is directly glued on the surface.

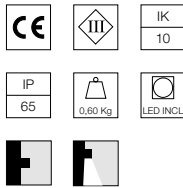
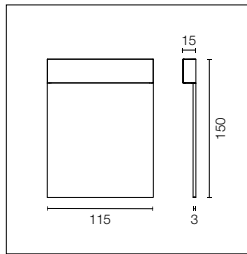

Alimentazione elettrica remota 24V da ordinare separatamente. Apparecchio fornito con due cavi di alimentazione da 200 mm e kit per la connessione IP. Prodotto in 3 differenti versioni; ordinare il codice corretto in base alla modalità di installazione:

- in muratura o in cemento con apposita cassaforma da incasso da ordinare separatamente.
- in parete di cartongesso con apposite molle incluse (per contropareti spessore min 5 mm- max 20 mm).
- in muratura o in cemento senza cassaforma da incasso: l'apparecchio viene incollato direttamente sulla superficie (collante da scegliere a cura dell'installatore in base al materiale su cui andrà installato l'apparecchio).

Remote power supply 24V to be ordered separately. The fixture is prewired with 200mm cable and an IP connection kit. 3 version available (select the model suitable for your type of installation):

- in concrete surface with recessed box to be ordered separately.
- in plasterboard surface (surface thickness min 5mm- max20mm) model supplied with springs.
- on solid surface no recessed box needed, the fixtures is directly glued on the surface (type of gluing to be select by the operator based on the type of surface).

2200K disponibile su richiesta.

2200K available on request.

Low-Power Led: 3W - 180 lm ≠ FIXT 71 lm - 2700K/CRI 80 - 24V / 3W - 200 lm ≠ FIXT 82 lm - 3000K/CRI 80 - 24V

**2700K**

Installazione in muratura con cassaforma/  
Installation in masonry with box for installation

- F5960044
- F5960047
- F5960055
- F5960066

**3000K**

- F5961044
- F5961047
- F5961055
- F5961066

Installazione in parete di cartongesso (min 5mm - max 20mm)/  
Installation in plasterboard wall

- F5980044
- F5980047
- F5980055
- F5980066

- F5981044
- F5981047
- F5981055
- F5981066

Installazione in muratura senza cassaforma/  
Installation in masonry without box for installation

- F5970044
- F5970047
- F5970055
- F5970066

- F5971044
- F5971047
- F5971055
- F5971066

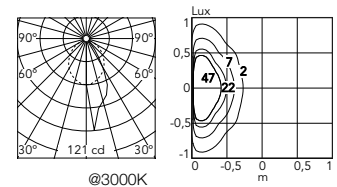



## Real Matter: Accessori / Accessories

Cassaforma per muratura o parete in cemento.

Box for installation for masonry or concrete wall.

F5962000

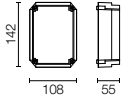

### Installazione in Muratura con Cassaforma / Installation in Masonry with Box for Installation

cassaforma a filo parete  
flush with the installation surface

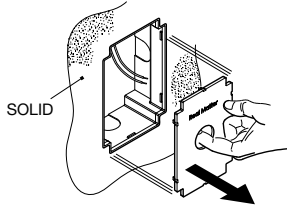

cassaforma / box for installation  
cod.F5962000

cablaggio con alimentatore remoto  
wiring with remote power supply

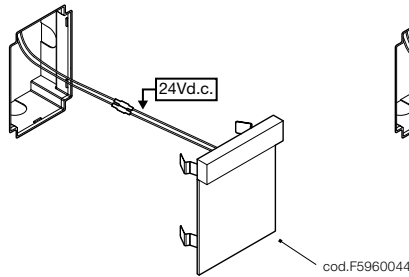

opzionale / optional  
cablaggio con alimentatore / wiring with power supply  
cod.RF25748

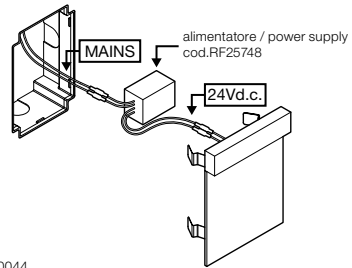

### Installazione in Parete di Cartongesso / Installation in Plasterboard Wall

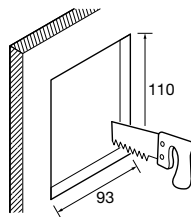

min 5 - max 20

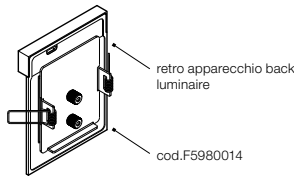

cablaggio con alimentatore remoto wiring  
with remote power supply

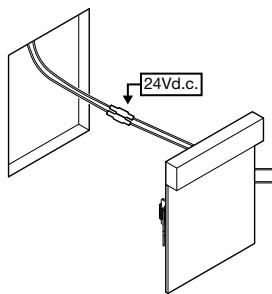

opzionale / optional  
cablaggio con alimentatore / wiring with power supply  
cod.RF25748

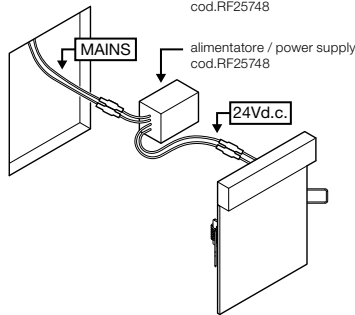

posizione corretta schermo  
cover correct positioning

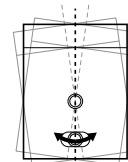

ruotabile / adjustable

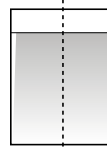

### Installazione in Muratura senza Cassaforma / Installation in Masonry without Box for Installation

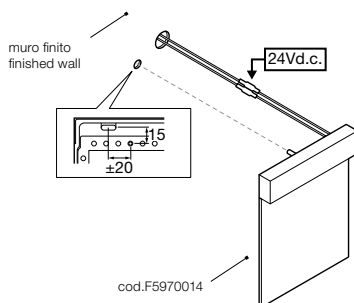

cod.F5970014

retro apparecchio back  
luminaire

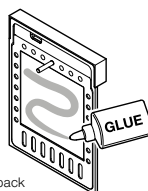



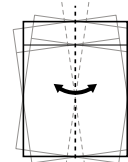



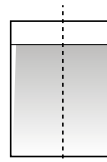

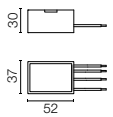

posizione corretta schermo  
cover correct positioning

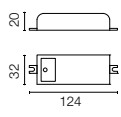

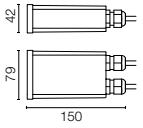
ruotabile / adjustable

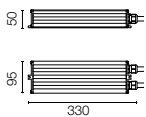

## Real Matter: Driver / Drivers

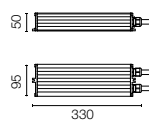
Alimentatore 24Vdc 8W / 110-240V IP65 Classe II selv.	Power supply 24Vdc 8W / 110-240V IP65 Class II selv.	*RF25748		
Può essere alloggiato nella cassaforma F5962000.	It can be housed in installation box F5962000.			
Alimentatore per installazione remota 24Vdc 10W / 110-240V IP20 Classe II selv.	Power supply for remote installation 24Vdc 10W / 110-240V IP20 Class II selv.	*RF25747		
Alimentatore per installazione remota 24Vdc 20W / 220-240V IP67 Classe II selv.	Power supply for remote installation 24Vdc 20W / 220-240V IP67 Class II selv.	*RF25752		
Alimentatore per installazione remota 24Vdc 50W / 120-240V IP67 Classe II selv.	Power supply for remote installation 24Vdc 50W / 120-240V IP67 Class II selv.	*F990B28A000		
Alimentatore 24Vdc 35W / 120-270V IP67 Classe II selv.	Power supply 24Vdc 35W / 120-270V IP67 Class II selv.	*F990B23AZ00		
Alimentatore per installazione remota 24Vdc 70W / 220-240V IP67 Classe II selv.	Power supply for remote installation 24Vdc 70W / 220-240V IP67 Class II selv.	*F990B27A000		
Alimentatore per installazione remota 24Vdc 96W / 120-240V IP67 Classe II selv.	Power supply for remote installation 24Vdc 96W / 120-240V IP67 Class II selv.	*F990B29A000		

\* Numero massimo di apparecchi per alimentatore / Maximum number of luminaires per power supply.

Numero massimo di apparecchi per alimentatore (Vin220÷240). Dati indicativi da verificare con le specifiche condizioni di installazione.	Maximum number of luminaires per power supply. (220÷240 V). These data must be checked taking into account the specific installation conditions.	Acc.	
		Acc. RF25748	2
		Acc. RF25747	3
		Acc. RF25757	3
		Acc. RF25752	5
		Acc. F990B23AZ00	9
		Acc. F990B28A000	13
		Acc. F990B27A000	19
		Acc. F990B29A000	27

## Real Matter: Driver / Drivers

Alimentatore per installazione remota 24Vdc 17W / 110-240V (15W@110V) IP20 Classe II selv.

Power supply for remote installation 24Vdc 17W / 110-240V (15W@110V) IP20 Class II selv.

\*RF25750  
 Dimmable 1-10V

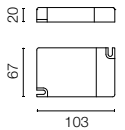

Alimentatore per installazione remota 24Vdc 20W / 110-240Vdc (15W@110V) IP67 Classe II selv.

Power supply for remote installation 24Vdc 20W / 110-240Vdc (15W@110V) IP67 Class II selv.

\*RF26387.A  
 Dimmable DALI

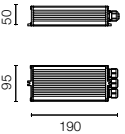

\* Numero massimo di apparecchi per alimentatore / Maximum number of luminaires per power supply.

Numero massimo di apparecchi per alimentatore (Vin220÷240). Dati indicativi da verificare con le specifiche condizioni di installazione.

Maximum number of luminaires per power supply. (220÷240 V). These data must be checked taking into account the specific installation conditions.

Acc. RF25750	4
Acc. RF26387.A	5

