

LEVEL

Pendelleuchte / hanging lamp / lampe à suspension / luce a sospensione

Lieferumfang:
Scope of supply:
contenu de la livraison:
consegna

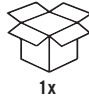

1

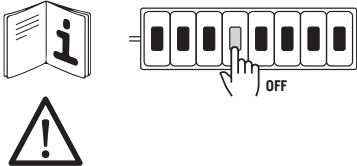

2

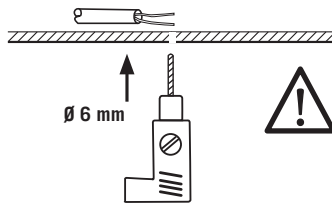

3

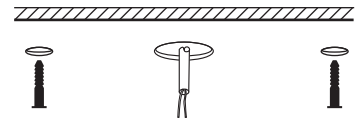

4

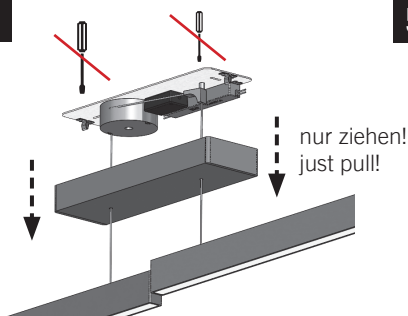

5

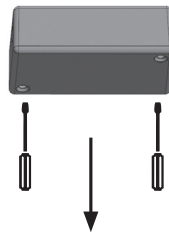

6

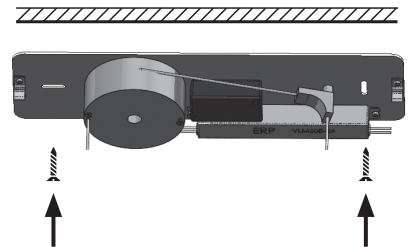

7

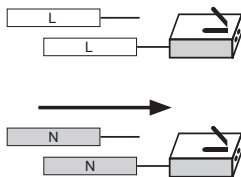

8

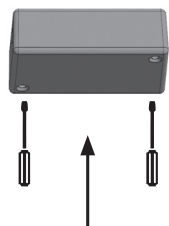

9

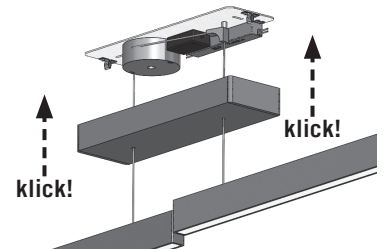

10



11

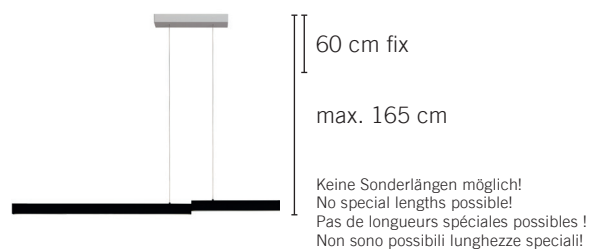

12

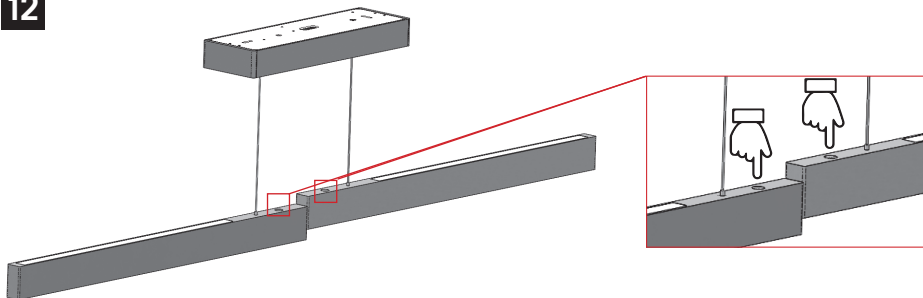

5.000 K
2.300 K

D

Ober-/ Unterlicht getrennt
dimm- und farbsteuerbar
über 2 Taster:
1 x drücken + halten = dimmen
2 x drücken + halten = Farbwechsel

GB

Up / down light separately
dimmable and colour controllable
via 2 push-buttons:
press once + hold = dim
press twice + hold = color change

F

L'éclairage supérieur/inférieur
peut être gradué et commandé
en couleur séparément par 2 bou-
tons-poussoirs:
1 x pression + maintien = dim
Appuyer + maintenir 2 x =
changement de couleur

IT

Luce superiore/inferiore dimmerabile
separatamente e colore regolabile
tramite 2 pulsanti:
1 x premere + tenere premuto = dim
Premere + tenere premuto 2 x =
cambio di colore

LEVEL

Pendelleuchte / hanging lamp / lampe à suspension / luce a sospensione

13

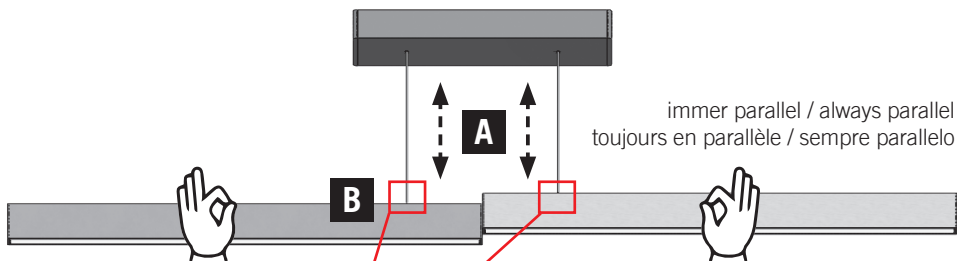

B

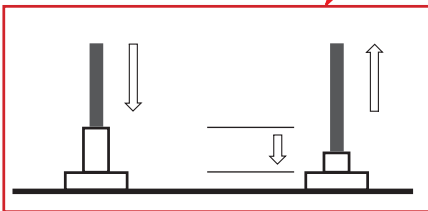

FEINJUSTIERUNG: Wenn das Pendelelement nicht ausbalanciert ist, kann dies an den Seilen korrigiert werden, indem etwas Kabel in das Pendel eingeschoben wird.

FINE ADJUSTMENT: If the pendulum element is not balanced, this can be corrected at the ropes by inserting some cable into the pendulum.

AJUSTEMENT FIN : Si l'élément pendulaire n'est pas équilibré, cela peut être corrigé au niveau des câbles en insérant un peu de câble dans le pendule.

REGOLAZIONE FINE: Se l'elemento del pendolo non è bilanciato, questo può essere corretto alle corde inserendo un cavo nel pendolo.

A

HÖHENVERSTELLUNG DURCH LIFTSYSTEM

- Die Montage des Gehäuses an der Decke fertigstellen.
- Prüfen Sie die Kabelführung im Deckengehäuse auf Freigängigkeit.
- Die Kabel müssen durch das Gewicht der Leuchte gespannt sein und während der Betätigung gespannt bleiben.
- Mit beiden Händen die Leuchte mittig nach unten und oben bewegen.
- Zu rasche Bewegungen vermeiden
- Seitliches Ziehen vermeiden.

> Bei Nichtbeachtung der Hinweise können die Kabel oder die Höhenverstellung beschädigt werden.

RÉGLAGE DE LA HAUTEUR PAR SYSTÈME D'ASCENSEUR

- Terminer le montage du boîtier au plafond.
- Vérifier la liberté de mouvement des câbles dans le boîtier au plafond.
- Les câbles doivent être tendus par le poids du luminaire et rester tendus pendant l'actionnement.
- Avec les deux mains, déplacer le luminaire vers le bas et vers le haut en le centrant.
- Éviter les mouvements trop brusques.
- Éviter de tirer sur les côtés.

> Le non-respect de ces consignes peut endommager les câbles ou le réglage de la hauteur.

HEIGHT ADJUSTMENT BY LIFT SYSTEM

- Complete the mounting of the housing on the ceiling.
- Check the cable routing in the ceiling housing for free movement.
- The cables must be tensioned by the weight of the luminaire and remain tensioned during operation.
- Use both hands to move the luminaire centrally downwards and upwards.
- Avoid too rapid movements.
- Avoid pulling sideways

> Failure to observe the instructions may result in damage to the cables or the height adjustment.

REGOLAZIONE DELL'ALTEZZA TRAMITE SISTEMA DI SOLLEVAMENTO

- Completare il montaggio dell'alloggiamento sul soffitto.
- Controllare che il passaggio dei cavi nell'alloggiamento del soffitto sia libero di muoversi.
- I cavi devono essere messi in tensione dal peso dell'apparecchio e rimanere in tensione durante il funzionamento.
- Utilizzare entrambe le mani per spostare l'apparecchio centralmente verso il basso e verso l'alto.
- Evitare movimenti troppo rapidi.
- Evitare di tirare di lato.

> Se non si seguono le istruzioni, i cavi o la regolazione dell'altezza potrebbero danneggiarsi.

Technische Angaben / technical data / specifications techniques / specifiche tecniche

02.2024

Art. Nr.: 138 602 00 / 139 602 00 / 141 602 00

230V ~ 50Hz; 4.368 lm - 2.300 K; 5.250 lm - 5.000 K (41 W cpl.); Ra90

Art. Nr.: 138 902 00 / 139 902 00 / 141 902 00

230V ~ 50Hz; 6.032 lm - 2.300 K; 7.250 lm - 5.000 K (57 W cpl.); Ra90

