



Dooku

ITALIANO / ENGLISH

FLOS

Outdoor

Dooku







Famiglia / Family

Dooku 400 Wall



Power Led

up to 39W
up to 2946 lm - 2700K/CRI 80
up to 3168 lm - 3000K/CRI 80
up to 3374 lm - 4000K/CRI 80

* Net lumen output

2200K available on request.

Dooku 400 Pole/Double Pole Ø76

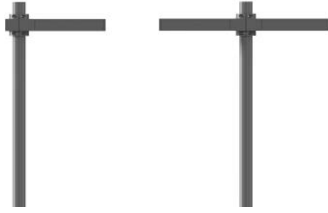

Power Led

up to 39W
up to 3389 lm - 2700K/CRI 80
up to 3631 lm - 3000K/CRI 80
up to 3752 lm - 4000K/CRI 80

* Net lumen output

2200K available on request.

Power Led

up to 2x39W
up to 2x3389 lm - 2700K/CRI 80
up to 2x3631 lm - 3000K/CRI 80
up to 2x3752 lm - 4000K/CRI 80

* Net lumen output

2200K available on request.

Dooku 400 Pole/Double Pole Ø102

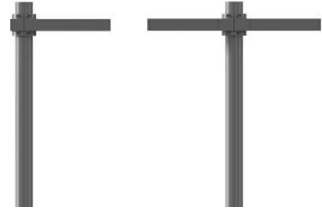

Power Led

up to 39W
up to 3389 lm - 2700K/CRI 80
up to 3631 lm - 3000K/CRI 80
up to 3752 lm - 4000K/CRI 80

* Net lumen output

2200K available on request.

Power Led

up to 2x39W
up to 2x3389 lm - 2700K/CRI 80
up to 2x3631 lm - 3000K/CRI 80
up to 2x3752 lm - 4000K/CRI 80

* Net lumen output

2200K available on request.

Dooku 600 Pole/Double Pole Ø76



Power Led

up to 78W
up to 6779 lm - 2700K/CRI 80
up to 7263 lm - 3000K/CRI 80
up to 7505 lm - 4000K/CRI 80

* Net lumen output

2200K available on request.

Power Led

up to 2x78W
up to 2x6779 lm - 2700K/CRI 80
up to 2x7263 lm - 3000K/CRI 80
up to 2x7505 lm - 4000K/CRI 80

* Net lumen output

2200K available on request.

Dooku 600 Pole/Double Pole Ø102

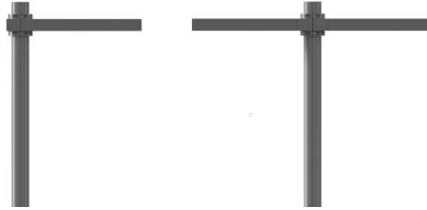

Power Led

up to 78W
up to 6779 lm - 2700K/CRI 80
up to 7263 lm - 3000K/CRI 80
up to 7505 lm - 4000K/CRI 80

* Net lumen output

2200K available on request.

Power Led

up to 2x78W
up to 2x6779 lm - 2700K/CRI 80
up to 2x7263 lm - 3000K/CRI 80
up to 2x7505 lm - 4000K/CRI 80

* Net lumen output

2200K available on request.

Colori / Colours



06 Grey



33 Anthracite

Descrizione / Description

Famiglia completa di apparecchi di illuminazione con sorgente luminosa a LED a proiezione, predisposti per installazione a parete e a palo come testapalo. Disponibile in due lunghezze e in varie ottiche per dimensione, comprese ottiche stradali per applicazioni in contesto urbano. Corpo in estruso di alluminio con parti di chiusura in alluminio pressofuso lega EN AB 47100 (a basso contenuto di rame). Diffusore in vetro extrachiaro con bordo segrigrafato, fissato attraverso un sistema di incollaggio robotizzato. Disponibile in differenti finiture con rivestimento a doppio strato di polveri e sottoposte a trattamento di conversione chimica superficiale per una elevata resistenza alla corrosione. L'apparecchio è dotato di uno spezzone di cavo uscente in neoprene e connettore IP68 per il cablaggio facile e sicuro a tenuta stagna.

Dooku 400 Wall

Apparecchi orientabili a proiezione, predisposti per installazione a parete, disponibili in due fasci di apertura: simmetrica e asimmetrica per aree pubbliche e private urbane, spazi ampi, parcheggi. L'apparecchio è dotato di uno spezzone di cavo uscente in neoprene e connettori IP68 per il cablaggio facile e sicuro a tenuta stagna. La staffa di fissaggio zincata permette una orientabilità di 90° circa sull'asse verticale.

Dooku 400 / 600 Top Pole

Apparecchi testapalo predisposti per installazione a palo, disponibili in due lunghezze con differenze potenze e quattro fasci di apertura: simmetrico, asimmetrico, ottica stradale standard e ottica stradale dedicata per percorsi ciclo-pedonali per inserimento in contesto urbano. L'apparecchio è dotato di uno spezzone di cavo uscente in neoprene e connettori IP68 per il cablaggio facile e sicuro a tenuta stagna. Completano la gamma una serie completa di pali cilindrici di diverso diametro ed altezza da interrare o con base di fissaggio e tirafondi.

Complete family of tiltable projection luminaires with LED source for wall mounting and installation on masts. Available in two lengths and with different optics for every dimension, including optics for urban uses. Extruded EN AB-47100 die cast aluminum body and closing parts (with low copper content). Extraclear glass diffuser with silkscreen edge, attached with a robotic gluing system. Available in different finishes, with double-layered powder coating and chemical conversion surface treatment to ensure high corrosion resistance. Equipped with a neoprene cable section and IP68 connector to guarantee an easy, safe, and watertight connection.

Dooku 400 Wall

Tiltable projection luminaires for wall mounting. Available with two beam angles: symmetrical and asymmetrical for public, private, and urban areas, open spaces, or parking lots. Equipped with a neoprene cable section and IP68 connector to guarantee an easy, safe, and watertight connection. The zinc fixing bracket allows for a tilting of approx. 90° on the vertical axis.

Dooku 400 / 600 Top Pole

Mast luminaires for mounting on poles. Available in two lengths, with different output and four beam angles: symmetrical, asymmetrical, urban standard beam and a specific urban beam for pedestrian and bicycle lanes in urban contexts. Equipped with a neoprene cable section and IP68 connectors to guarantee an easy, safe, and watertight connection. Completed with a series of cylinder posts in different diameters and heights that can be ground recessed or fixed with an anchor plate and lag screws.

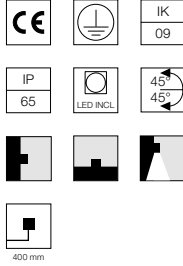
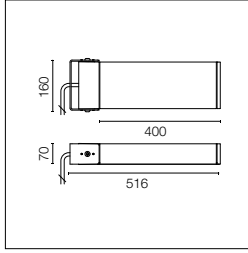

Sorgente a LED inclusa.
Alimentazione elettrica 220-240V ON/OFF e dimmerabile 1-10V o DALI integrata. Staffa di fissaggio inclusa. Dotato di spezzone di cavo uscente in neoprene 400 mm e connettore IP68.
Versione Smart- City a richiesta.

LED source included. Integrated power supply 220-240V ON/OFF and dimmable 1-10V or DALI. Fixing bracket included. Equipped with a 400mm protruding neoprene cable section and IP68 connectors.
Smart-City version available upon request.

2200K disponibile su richiesta.

2200K available on request.

Optic 120° (Wide Spaces - Public Areas - Parking Areas)

Power Led: 39W - 4122 lm ≠ OUTPUT 3389 lm - 2700K/CRI 80 - 220÷240V / 39W - 4416 lm ≠ OUTPUT 3631 lm - 3000K/CRI 80 - 220÷240V / 39W - 4563 lm ≠ OUTPUT 3752 lm - 4000K/CRI 80 - 220÷240V

2700K

- Non Dimmable
- FA53907606
- FA53907633
- 1-10V
- FA53907606-310
- FA53907633-310
- Dali
- FA53907606-300
- FA53907633-300

3000K

- Non Dimmable
- FA53907506
- FA53907533
- 1-10V
- FA53907506-310
- FA53907533-310
- Dali
- FA53907506-300
- FA53907533-300

4000K

- Non Dimmable
- FA53907406
- FA53907433
- 1-10V
- FA53907406-310
- FA53907433-310
- Dali
- FA53907406-300
- FA53907433-300

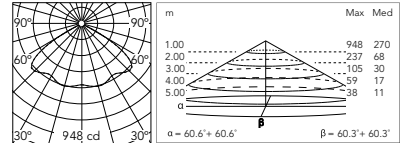

@ 3000K

Asymmetric Optic

Power Led: 39W - 4122 lm ≠ OUTPUT 3173 lm - 2700K/CRI 80 - 220÷240V / 39W - 4416 lm ≠ OUTPUT 3400 lm - 3000K/CRI 80 - 220÷240V / 39W - 4563 lm ≠ OUTPUT 3513 lm - 4000K/CRI 80 - 220÷240V

2700K

- Non Dimmable
- FA53913006
- FA53913033
- 1-10V
- FA53913006-310
- FA53913033-310
- Dali
- FA53913006-300
- FA53913033-300

3000K

- Non Dimmable
- FA53914806
- FA53914833
- 1-10V
- FA53914806-310
- FA53914833-310
- Dali
- FA53914806-300
- FA53914833-300

4000K

- Non Dimmable
- FA53916606
- FA53916633
- 1-10V
- FA53916606-310
- FA53916633-310
- Dali
- FA53916606-300
- FA53916633-300

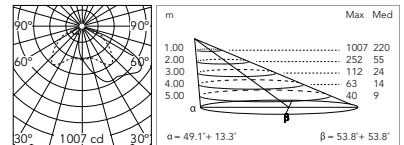

@ 3000K

Dooku 400 - Single Top Pole ø76

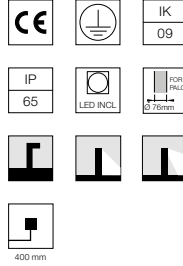
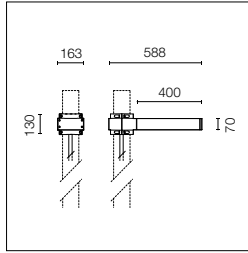

Sorgente a LED inclusa. Alimentazione elettrica 220-240V ON/OFF e dimmerabile 1-10V o DALI integrata. Staffa di fissaggio inclusa. Dotato di spezzone di cavo uscente in neoprene 400 mm e connettore IP68. Attacco singolo per pali diametro 76 mm, palo da ordinare separatamente. Versione Smart- City a richiesta.

LED source included. Integrated power supply 220-240V ON/OFF and dimmable 1-10V or DALI. Fixing bracket included. Equipped with a 400mm protruding neoprene cable section and IP68 connectors. Single socket for 76mm diameter post. The post must be ordered separately. Smart-City version available upon request.

2200K disponibile su richiesta.

2200K available on request.

Optic 120° (Wide Spaces - Public Areas - Parking Areas)

Power Led: 39W - 4122 lm ≠ OUTPUT 3389 lm - 2700K/CRI 80 - 220÷240V / 39W - 4416 lm ≠ OUTPUT 3631 lm - 3000K/CRI 80 - 220÷240V / 39W - 4563 lm ≠ OUTPUT 3752 lm - 4000K/CRI 80 - 220÷240V

2700K

Non Dimmable

- FA53907806
- FA53907833
- 1-10V
- FA53907806-310
- FA53907833-310
- Dali
- FA53907806-300
- FA53907833-300

3000K

Non Dimmable

- FA53903906
- FA53903933
- 1-10V
- FA53903906-310
- FA53903933-310
- Dali
- FA53903906-300
- FA53903933-300

4000K

Non Dimmable

- FA53903806
- FA53903833
- 1-10V
- FA53903806-310
- FA53903833-310
- Dali
- FA53903806-300
- FA53903833-300

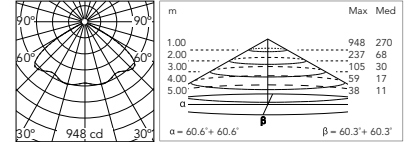

@ 3000K

Asymmetric Optic

Power Led: 39W - 4122 lm ≠ OUTPUT 3173 lm - 2700K/CRI 80 - 220÷240V / 39W - 4416 lm ≠ OUTPUT 3400 lm - 3000K/CRI 80 - 220÷240V / 39W - 4563 lm ≠ OUTPUT 3513 lm - 4000K/CRI 80 - 220÷240V

2700K

Non Dimmable

- FA53913206
- FA53913233
- 1-10V
- FA53913206-310
- FA53913233-310
- Dali
- FA53913206-300
- FA53913233-300

3000K

Non Dimmable

- FA53915006
- FA53915033
- 1-10V
- FA53915006-310
- FA53915033-310
- Dali
- FA53915006-300
- FA53915033-300

4000K

Non Dimmable

- FA53916806
- FA53916833
- 1-10V
- FA53916806-310
- FA53916833-310
- Dali
- FA53916806-300
- FA53916833-300

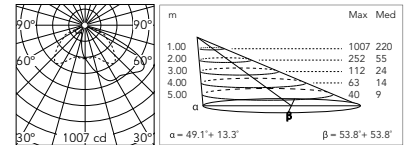

@ 3000K

Street Light Optic

Power Led: 39W - 4122 lm ≠ OUTPUT 3102 lm - 2700K/CRI 80 - 220÷240V / 39W - 4416 lm ≠ OUTPUT 3323 lm - 3000K/CRI 80 - 220÷240V / 39W - 4563 lm ≠ OUTPUT 3434 lm - 4000K/CRI 80 - 220÷240V

2700K

Non Dimmable

- FA53908006
- FA53908033
- 1-10V
- FA53908006-310
- FA53908033-310
- Dali
- FA53908006-300
- FA53908033-300

3000K

Non Dimmable

- FA53904206
- FA53904233
- 1-10V
- FA53904206-310
- FA53904233-310
- Dali
- FA53904206-300
- FA53904233-300

4000K

Non Dimmable

- FA53904106
- FA53904133
- 1-10V
- FA53904106-310
- FA53904133-310
- Dali
- FA53904106-300
- FA53904133-300

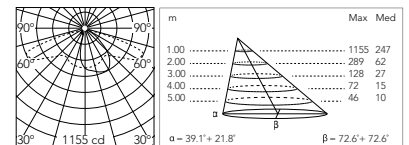

@ 3000K

Street Light Optic (Foot and Cycle Paths)

Power Led: 39W - 4122 lm ≠ OUTPUT 3130 lm - 2700K/CRI 80 - 220÷240V / 39W - 4416 lm ≠ OUTPUT 3354 lm - 3000K/CRI 80 - 220÷240V / 39W - 4563 lm ≠ OUTPUT 3466 lm - 4000K/CRI 80 - 220÷240V

2700K

Non Dimmable

- FA53908206
- FA53908233
- 1-10V
- FA53908206-310
- FA53908233-310
- Dali
- FA53908206-300
- FA53908233-300

3000K

Non Dimmable

- FA53904506
- FA53904533
- 1-10V
- FA53904506-310
- FA53904533-310
- Dali
- FA53904506-300
- FA53904533-300

4000K

Non Dimmable

- FA53904406
- FA53904433
- 1-10V
- FA53904406-310
- FA53904433-310
- Dali
- FA53904406-300
- FA53904433-300

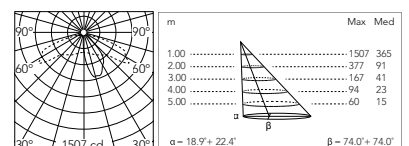

@ 3000K

Dooku 400 - Double Top Pole ø76

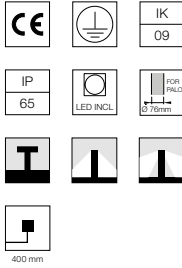
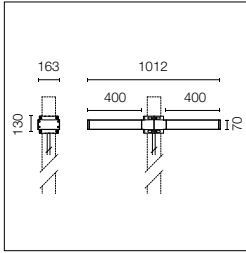

Sorgente a LED inclusa. Alimentazione elettrica 220-240V ON/OFF e dimmerabile 1-10V o DALI integrata. Staffa di fissaggio inclusa. Dotato di spezzone di cavo uscente in neoprene 400 mm e connettore IP68. Attacco doppio per pali diametro 76 mm, palo da ordinare separatamente. Versione Smart-City a richiesta.

LED source included. Integrated power supply 220-240V ON/OFF and dimmable 1-10V or DALI. Fixing bracket included. Equipped with a 400mm protruding neoprene cable section and IP68 connectors. Double socket for 76mm diameter post. The post must be ordered separately. Smart-City version available upon request.

2200K disponibile su richiesta.

2200K available on request.

Optic 120° (Wide Spaces - Public Areas - Parking Areas)

Power Led: 39W - 2x4122 lm ≠ OUTPUT 2x3389 lm - 2700K/CRI 80 - 220÷240V / 39W - 2x4416 lm ≠ OUTPUT 2x3631 lm - 3000K/CRI 80 - 220÷240V / 39W - 2x4563 lm ≠ OUTPUT 2x3752 lm - 4000K/CRI 80 - 220÷240V

2700K

- Non Dimmable
- FA53908406
 - FA53908433
- 1-10V
- FA53908406-310
 - FA53908433-310
- Dali
- FA53908406-300
 - FA53908433-300

3000K

- Non Dimmable
- FA53904806
 - FA53904833
- 1-10V
- FA53904806-310
 - FA53904833-310
- Dali
- FA53904806-300
 - FA53904833-300

4000K

- Non Dimmable
- FA53904706
 - FA53904733
- 1-10V
- FA53904706-310
 - FA53904733-310
- Dali
- FA53904706-300
 - FA53904733-300

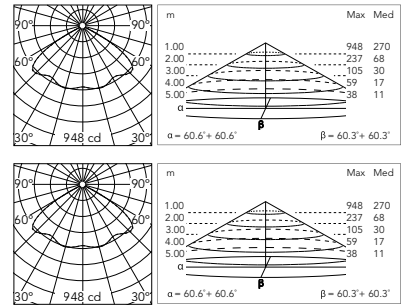

Asymmetric Optic

Power Led: 39W - 2x4122 lm ≠ OUTPUT 2x3173 lm - 2700K/CRI 80 - 220÷240V / 39W - 2x4416 lm ≠ OUTPUT 2x3400 lm - 3000K/CRI 80 - 220÷240V / 39W - 2x4563 lm ≠ OUTPUT 2x3513 lm - 4000K/CRI 80 - 220÷240V

2700K

- Non Dimmable
- FA53913406
 - FA53913433
- 1-10V
- FA53913406-310
 - FA53913433-310
- Dali
- FA53913406-300
 - FA53913433-300

3000K

- Non Dimmable
- FA53915206
 - FA53915233
- 1-10V
- FA53915206-310
 - FA53915233-310
- Dali
- FA53915206-300
 - FA53915233-300

4000K

- Non Dimmable
- FA53917006
 - FA53917033
- 1-10V
- FA53917006-310
 - FA53917033-310
- Dali
- FA53917006-300
 - FA53917033-300

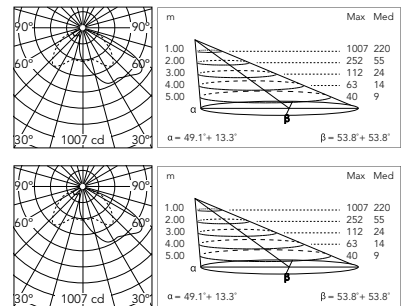

@ 3000K

@ 3000K

Street Light Optic

Power Led: 39W - 2x4122 lm ≠ OUTPUT 2x3102 lm - 2700K/CRI 80 - 220÷240V / 39W - 2x4416 lm ≠ OUTPUT 2x3323 lm - 3000K/CRI 80 - 220÷240V / 39W - 2x4563 lm ≠ OUTPUT 2x3434 lm - 4000K/CRI 80 - 220÷240V

2700K

- Non Dimmable
- FA53908606
 - FA53908633
- 1-10V
- FA53908606-310
 - FA53908633-310
- Dali
- FA53908606-300
 - FA53908633-300

3000K

- Non Dimmable
- FA53905106
 - FA53905133
- 1-10V
- FA53905106-310
 - FA53905133-310
- Dali
- FA53905106-300
 - FA53905133-300

4000K

- Non Dimmable
- FA53905006
 - FA53905033
- 1-10V
- FA53905006-310
 - FA53905033-310
- Dali
- FA53905006-300
 - FA53905033-300

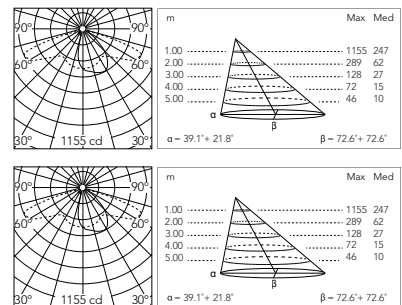

@ 3000K

Street Light Optic (Foot and Cycle Paths)

Power Led: 39W - 2x4122 lm ≠ OUTPUT 2x3130 lm - 2700K/CRI 80 - 220÷240V / 39W - 2x4416 lm ≠ OUTPUT 2x3354 lm - 3000K/CRI 80 - 220÷240V / 39W - 2x4563 lm ≠ OUTPUT 2x3466 lm - 4000K/CRI 80 - 220÷240V

2700K

- Non Dimmable
- FA53908806
 - FA53908833
- 1-10V
- FA53908806-310
 - FA53908833-310
- Dali
- FA53908806-300
 - FA53908833-300

3000K

- Non Dimmable
- FA53905406
 - FA53905433
- 1-10V
- FA53905406-310
 - FA53905433-310
- Dali
- FA53905406-300
 - FA53905433-300

4000K

- Non Dimmable
- FA53905306
 - FA53905333
- 1-10V
- FA53905306-310
 - FA53905333-310
- Dali
- FA53905306-300
 - FA53905333-300

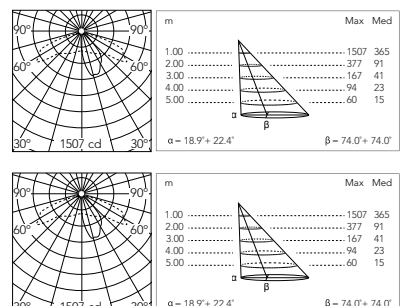

@ 3000K

Dooku 400 - Single Top Pole ø102

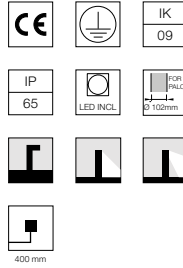
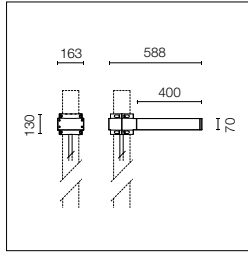

Sorgente a LED inclusa. Alimentazione elettrica 220-240V ON/OFF e dimmerabile 1-10V o DALI integrata. Staffa di fissaggio inclusa. Dotato di spezzone di cavo uscente in neoprene 400 mm e connettore IP68. Attacco singolo per pali diametro 102mm, palo da ordinare separatamente. Versione Smart- City a richiesta.

LED source included. Integrated power supply 220-240V ON/OFF and dimmable 1-10V or DALI. Fixing bracket included. Equipped with a 400mm protruding neoprene cable section and IP68 connectors. Smart-City version available upon request. Single socket for 102mm diameter post. The post must be ordered separately. Smart-City version available upon request.

2200K disponibile su richiesta.

2200K available on request.

Optic 120° (Wide Spaces - Public Areas - Parking Areas)

Power Led: 39W - 4122 lm ≠ OUTPUT 3389 lm - 2700K/CRI 80 - 220÷240V / 39W - 4416 lm ≠ OUTPUT 3631 lm - 3000K/CRI 80 - 220÷240V / 39W - 4563 lm ≠ OUTPUT 3752 lm - 4000K/CRI 80 - 220÷240V

2700K

Non Dimmable

- FA53909006
- FA53909033
- 1-10V
- FA53909006-310
- FA53909033-310
- Dali
- FA53909006-300
- FA53909033-300

3000K

Non Dimmable

- FA53905706
- FA53905733
- 1-10V
- FA53905706-310
- FA53905733-310
- Dali
- FA53905706-300
- FA53905733-300

4000K

Non Dimmable

- FA53905606
- FA53905633
- 1-10V
- FA53905606-310
- FA53905633-310
- Dali
- FA53905606-300
- FA53905633-300

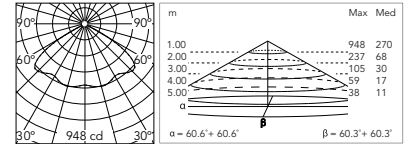

@ 3000K

Asymmetric Optic

Power Led: 39W - 4122 lm ≠ OUTPUT 3173 lm - 2700K/CRI 80 - 220÷240V / 39W - 4416 lm ≠ OUTPUT 3400 lm - 3000K/CRI 80 - 220÷240V / 39W - 4563 lm ≠ OUTPUT 3513 lm - 4000K/CRI 80 - 220÷240V

2700K

Non Dimmable

- FA53913606
- FA53913633
- 1-10V
- FA53913606-310
- FA53913633-310
- Dali
- FA53913606-300
- FA53913633-300

3000K

Non Dimmable

- FA53915406
- FA53915433
- 1-10V
- FA53915406-310
- FA53915433-310
- Dali
- FA53915406-300
- FA53915433-300

4000K

Non Dimmable

- FA53917206
- FA53917233
- 1-10V
- FA53917206-310
- FA53917233-310
- Dali
- FA53917206-300
- FA53917233-300

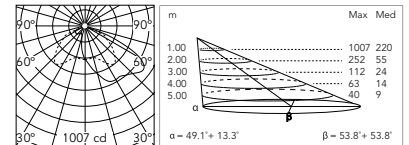

@ 3000K

Street Light Optic

Power Led: 39W - 4122 lm ≠ OUTPUT 3102 lm - 2700K/CRI 80 - 220÷240V / 39W - 4416 lm ≠ OUTPUT 3323 lm - 3000K/CRI 80 - 220÷240V / 39W - 4563 lm ≠ OUTPUT 3434 lm - 4000K/CRI 80 - 220÷240V

2700K

Non Dimmable

- FA53909206
- FA53909233
- 1-10V
- FA53909206-310
- FA53909233-310
- Dali
- FA53909206-300
- FA53909233-300

3000K

Non Dimmable

- FA53906006
- FA53906033
- 1-10V
- FA53906006-310
- FA53906033-310
- Dali
- FA53906006-300
- FA53906033-300

4000K

Non Dimmable

- FA53905906
- FA53905933
- 1-10V
- FA53905906-310
- FA53905933-310
- Dali
- FA53905906-300
- FA53905933-300

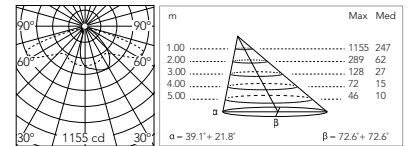

@ 3000K

Street Light Optic (Foot and Cycle Paths)

Power Led: 39W - 4122 lm ≠ OUTPUT 3130 lm - 2700K/CRI 80 - 220÷240V / 39W - 4416 lm ≠ OUTPUT 3354 lm - 3000K/CRI 80 - 220÷240V / 39W - 4563 lm ≠ OUTPUT 3466 lm - 4000K/CRI 80 - 220÷240V

2700K

Non Dimmable

- FA53909406
- FA53909433
- 1-10V
- FA53909406-310
- FA53909433-310
- Dali
- FA53909406-300
- FA53909433-300

3000K

Non Dimmable

- FA53906306
- FA53906333
- 1-10V
- FA53906306-310
- FA53906333-310
- Dali
- FA53906306-300
- FA53906333-300

4000K

Non Dimmable

- FA53906206
- FA53906233
- 1-10V
- FA53906206-310
- FA53906233-310
- Dali
- FA53906206-300
- FA53906233-300

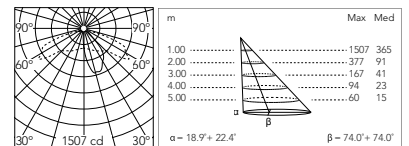

@ 3000K

Dooku 400 - Double Top Pole ø102

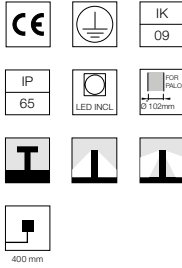
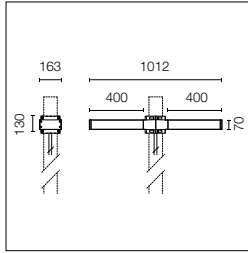

Sorgente a LED inclusa. Alimentazione elettrica 220-240V ON/OFF e dimmerabile 1-10V o DALI integrata. Staffa di fissaggio inclusa. Dotato di spezzone di cavo uscente in neoprene 400 mm e connettore IP68. Attacco doppio per pali diametro 102 mm, palo da ordinare separatamente. Versione Smart-City a richiesta.

LED source included. Integrated power supply 220-240V ON/OFF and dimmable 1-10V or DALI. Fixing bracket included. Equipped with a 400mm protruding neoprene cable section and IP68 connectors. Double socket for 102mm diameter post. The post must be ordered separately. Smart-City version available upon request.

2200K disponibile su richiesta.

2200K available on request.

Optic 120° (Wide Spaces - Public Areas - Parking Areas)

Power Led: 39W - 2x4122 lm ≠ OUTPUT 2x3389 lm - 2700K/CRI 80 - 220÷240V / 39W - 2x4416 lm ≠ OUTPUT 2x3631 lm - 3000K/CRI 80 - 220÷240V / 39W - 2x4563 lm ≠ OUTPUT 2x3752 lm - 4000K/CRI 80 - 220÷240V

2700K

- Non Dimmable
- FA53909606
- FA53909633
- 1-10V
- FA53909606-310
- FA53909633-310
- Dali
- FA53909606-300
- FA53909633-300

3000K

- Non Dimmable
- FA53906606
- FA53906633
- 1-10V
- FA53906606-310
- FA53906633-310
- Dali
- FA53906606-300
- FA53906633-300

4000K

- Non Dimmable
- FA53906506
- FA53906533
- 1-10V
- FA53906506-310
- FA53906533-310
- Dali
- FA53906506-300
- FA53906533-300

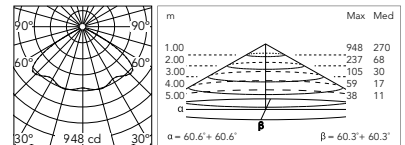
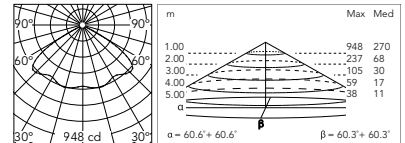

@ 3000K

Asymmetric Optic

Power Led: 39W - 2x4122 lm ≠ OUTPUT 2x3173 lm - 2700K/CRI 80 - 220÷240V / 39W - 2x4416 lm ≠ OUTPUT 2x3400 lm - 3000K/CRI 80 - 220÷240V / 39W - 2x4563 lm ≠ OUTPUT 2x3513 lm - 4000K/CRI 80 - 220÷240V

2700K

- Non Dimmable
- FA53913806
- FA53913833
- 1-10V
- FA53913806-310
- FA53913833-310
- Dali
- FA53913806-300
- FA53913833-300

3000K

- Non Dimmable
- FA53915606
- FA53915633
- 1-10V
- FA53915606-310
- FA53915633-310
- Dali
- FA53915606-300
- FA53915633-300

4000K

- Non Dimmable
- FA53917406
- FA53917433
- 1-10V
- FA53917406-310
- FA53917433-310
- Dali
- FA53917406-300
- FA53917433-300

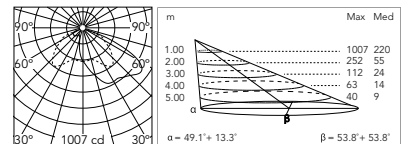
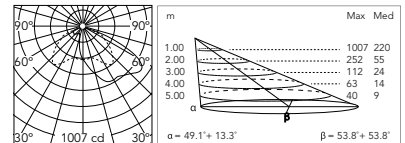

@ 3000K

Street Light Optic

Power Led: 39W - 2x4122 lm ≠ OUTPUT 2x3102 lm - 2700K/CRI 80 - 220÷240V / 39W - 2x4416 lm ≠ OUTPUT 2x3323 lm - 3000K/CRI 80 - 220÷240V / 39W - 2x4563 lm ≠ OUTPUT 2x3434 lm - 4000K/CRI 80 - 220÷240V

2700K

- Non Dimmable
- FA53909806
- FA53909833
- 1-10V
- FA53909806-310
- FA53909833-310
- Dali
- FA53909806-300
- FA53909833-300

3000K

- Non Dimmable
- FA53906906
- FA53906933
- 1-10V
- FA53906906-310
- FA53906933-310
- Dali
- FA53906906-300
- FA53906933-300

4000K

- Non Dimmable
- FA53906806
- FA53906833
- 1-10V
- FA53906806-310
- FA53906833-310
- Dali
- FA53906806-300
- FA53906833-300

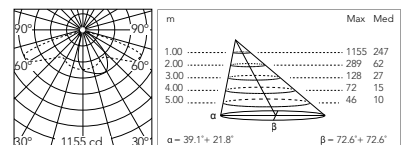
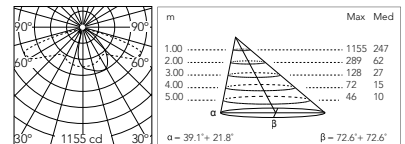

@ 3000K

Street Light Optic (Foot and Cycle Paths)

Power Led: 39W - 2x4122 lm ≠ OUTPUT 2x3130 lm - 2700K/CRI 80 - 220÷240V / 39W - 2x4416 lm ≠ OUTPUT 2x3354 lm - 3000K/CRI 80 - 220÷240V / 39W - 2x4563 lm ≠ OUTPUT 2x3466 lm - 4000K/CRI 80 - 220÷240V

2700K

- Non Dimmable
- FA53910006
- FA53910033
- 1-10V
- FA53910006-310
- FA53910033-310
- Dali
- FA53910006-300
- FA53910033-300

3000K

- Non Dimmable
- FA53907206
- FA53907233
- 1-10V
- FA53907206-310
- FA53907233-310
- Dali
- FA53907206-300
- FA53907233-300

4000K

- Non Dimmable
- FA53907106
- FA53907133
- 1-10V
- FA53907106-310
- FA53907133-310
- Dali
- FA53907106-300
- FA53907133-300

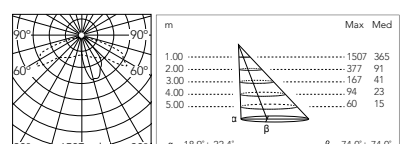
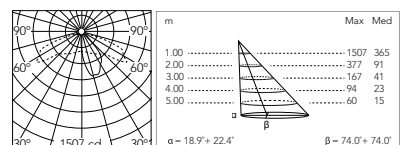

@ 3000K

Dooku 600 - Single Top Pole ø76

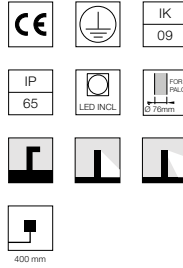
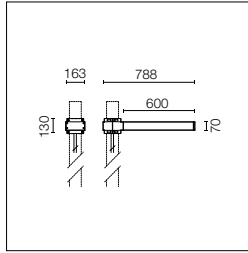

Sorgente a LED inclusa. Alimentazione elettrica 220-240V ON/OFF e dimmerabile 1-10V o DALI integrata. Staffa di fissaggio inclusa. Dotato di spezzone di cavo uscente in neoprene 400 mm e connettore IP68. Attacco singolo per pali diametro 76mm, palo da ordinare separatamente. Versione Smart- City a richiesta.

LED source included. Integrated power supply 220-240V ON/OFF and dimmable 1-10V or DALI. Fixing bracket included. Equipped with a 400mm protruding neoprene cable section and IP68 connectors. Smart-City version available upon request. Single socket for 76mm diameter post. The post must be ordered separately. Smart-City version available upon request.

2200K disponibile su richiesta.

2200K available on request.

Optic 120° (Wide Spaces - Public Areas - Parking Areas)

Power Led: 78W - 8243 lm ≠ OUTPUT 6779 lm - 2700K/CRI 80 - 220÷240V / 78W - 8832 lm ≠ OUTPUT 7263 lm - 3000K/CRI 80 - 220÷240V / 78W - 9126 lm ≠ OUTPUT 7505 lm - 4000K/CRI 80 - 220÷240V

2700K

Non Dimmable

- FA53910206
- FA53910233
- 1-10V
- FA53910206-310
- FA53910233-310
- Dali
- FA53910206-300
- FA53910233-300

3000K

Non Dimmable

- FA53900306
- FA53900333
- 1-10V
- FA53900306-310
- FA53900333-310
- Dali
- FA53900306-300
- FA53900333-300

4000K

Non Dimmable

- FA53900206
- FA53900233
- 1-10V
- FA53900206-310
- FA53900233-310
- Dali
- FA53900206-300
- FA53900233-300

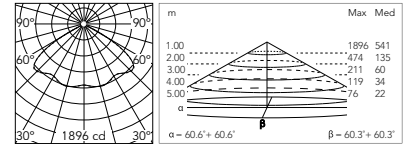

@ 3000K

Asymmetric Optic

Power Led: 78W - 8243 lm ≠ OUTPUT 6347 lm - 2700K/CRI 80 - 220÷240V / 78W - 8832 lm ≠ OUTPUT 6800 lm - 3000K/CRI 80 - 220÷240V / 78W - 9126 lm ≠ OUTPUT 7027 lm - 4000K/CRI 80 - 220÷240V

2700K

Non Dimmable

- FA53914006
- FA53914033
- 1-10V
- FA53914006-310
- FA53914033-310
- Dali
- FA53914006-300
- FA53914033-300

3000K

Non Dimmable

- FA53915806
- FA53915833
- 1-10V
- FA53915806-310
- FA53915833-310
- Dali
- FA53915806-300
- FA53915833-300

4000K

Non Dimmable

- FA53917606
- FA53917633
- 1-10V
- FA53917606-310
- FA53917633-310
- Dali
- FA53917606-300
- FA53917633-300

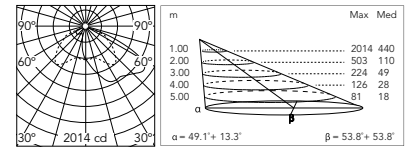

@ 3000K

Street Light Optic

Power Led: 78W - 8243 lm ≠ OUTPUT 6203 lm - 2700K/CRI 80 - 220÷240V / 78W - 8832 lm ≠ OUTPUT 6646 lm - 3000K/CRI 80 - 220÷240V / 78W - 9126 lm ≠ OUTPUT 6868 lm - 4000K/CRI 80 - 220÷240V

2700K

Non Dimmable

- FA53910406
- FA53910433
- 1-10V
- FA53910406-310
- FA53910433-310
- Dali
- FA53910406-300
- FA53910433-300

3000K

Non Dimmable

- FA53900606
- FA53900633
- 1-10V
- FA53900606-310
- FA53900633-310
- Dali
- FA53900606-300
- FA53900633-300

4000K

Non Dimmable

- FA53900506
- FA53900533
- 1-10V
- FA53900506-310
- FA53900533-310
- Dali
- FA53900506-300
- FA53900533-300

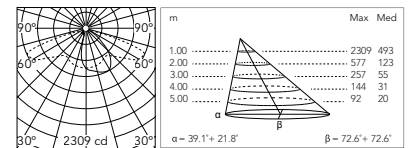

@ 3000K

Street Light Optic (Foot and Cycle Paths)

Power Led: 78W - 8243 lm ≠ OUTPUT 6261 lm - 2700K/CRI 80 - 220÷240V / 78W - 8832 lm ≠ OUTPUT 6708 lm - 3000K/CRI 80 - 220÷240V / 78W - 9126 lm ≠ OUTPUT 6932 lm - 4000K/CRI 80 - 220÷240V

2700K

Non Dimmable

- FA53910606
- FA53910633
- 1-10V
- FA53910606-310
- FA53910633-310
- Dali
- FA53910606-300
- FA53910633-300

3000K

Non Dimmable

- FA53900906
- FA53900933
- 1-10V
- FA53900906-310
- FA53900933-310
- Dali
- FA53900906-300
- FA53900933-300

4000K

Non Dimmable

- FA53900806
- FA53900833
- 1-10V
- FA53900806-310
- FA53900833-310
- Dali
- FA53900806-300
- FA53900833-300

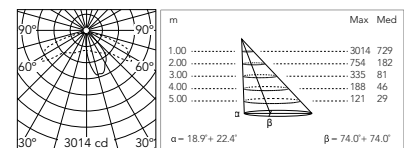

@ 3000K

Dooku 600 - Double Top Pole ø76

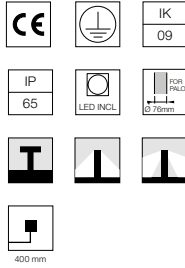
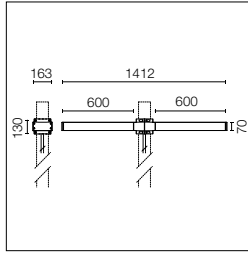

Sorgente a LED inclusa. Alimentazione elettrica 220-240V ON/OFF e dimmerabile 1-10V o DALI integrata. Staffa di fissaggio inclusa. Dotato di spezzone di cavo uscente in neoprene 400 mm e connettore IP68. Attacco doppio per pali diametro 76 mm, palo da ordinare separatamente. Versione Smart-City a richiesta.

LED source included. Integrated power supply 220-240V ON/OFF and dimmable 1-10V or DALI. Fixing bracket included. Equipped with a 400mm protruding neoprene cable section and IP68 connectors. Double socket for 76mm diameter post. The post must be ordered separately. Smart-City version available upon request.

2200K disponibile su richiesta.

2200K available on request.

Optic 120° (Wide Spaces - Public Areas - Parking Areas)

Power Led: 78W - 2x8243 lm ≠ OUTPUT 2x6779 lm - 2700K/CRI 80 - 220÷240V / 78W - 2x8832 lm ≠ OUTPUT 2x7263 lm - 3000K/CRI 80 - 220÷240V / 78W - 2x9126 lm ≠ OUTPUT 2x7505 lm - 4000K/CRI 80 - 220÷240V

2700K

- Non Dimmable
- FA53910806
 - FA53910833
- 1-10V
- FA53910806-310
 - FA53910833-310
- Dali
- FA53910806-300
 - FA53910833-300

3000K

- Non Dimmable
- FA53901206
 - FA53901233
- 1-10V
- FA53901206-310
 - FA53901233-310
- Dali
- FA53901206-300
 - FA53901233-300

4000K

- Non Dimmable
- FA53901106
 - FA53901133
- 1-10V
- FA53901106-310
 - FA53901133-310
- Dali
- FA53901106-300
 - FA53901133-300

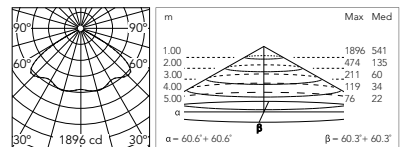
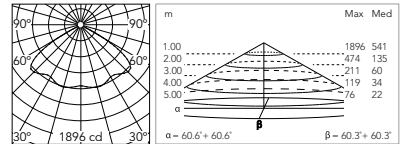

@ 3000K

Asymmetric Optic

Power Led: 78W - 2x8243 lm ≠ OUTPUT 2x6347 lm - 2700K/CRI 80 - 220÷240V / 78W - 2x8832 lm ≠ OUTPUT 2x6800 lm - 3000K/CRI 80 - 220÷240V / 78W - 2x9126 lm ≠ OUTPUT 2x7027 lm - 4000K/CRI 80 - 220÷240V

2700K

- Non Dimmable
- FA53914206
 - FA53914233
- 1-10V
- FA53914206-310
 - FA53914233-310
- Dali
- FA53914206-300
 - FA53914233-300

3000K

- Non Dimmable
- FA53916006
 - FA53916033
- 1-10V
- FA53916006-310
 - FA53916033-310
- Dali
- FA53916006-300
 - FA53916033-300

4000K

- Non Dimmable
- FA53917806
 - FA53917833
- 1-10V
- FA53917806-310
 - FA53917833-310
- Dali
- FA53917806-300
 - FA53917833-300

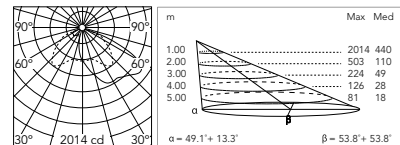
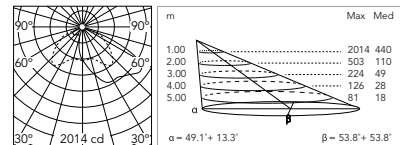

@ 3000K

Street Light Optic

Power Led: 78W - 2x8243 lm ≠ OUTPUT 2x6203 lm - 2700K/CRI 80 - 220÷240V / 78W - 2x8832 lm ≠ OUTPUT 2x6646 lm - 3000K/CRI 80 - 220÷240V / 78W - 2x9126 lm ≠ OUTPUT 2x6868 lm - 4000K/CRI 80 - 220÷240V

2700K

- Non Dimmable
- FA53911006
 - FA53911033
- 1-10V
- FA53911006-310
 - FA53911033-310
- Dali
- FA53911006-300
 - FA53911033-300

3000K

- Non Dimmable
- FA53901506
 - FA53901533
- 1-10V
- FA53901506-310
 - FA53901533-310
- Dali
- FA53901506-300
 - FA53901533-300

4000K

- Non Dimmable
- FA53901406
 - FA53901433
- 1-10V
- FA53901406-310
 - FA53901433-310
- Dali
- FA53901406-300
 - FA53901433-300

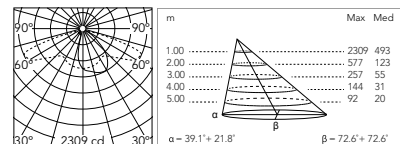
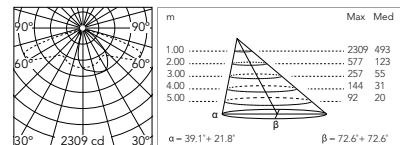

@ 3000K

Street Light Optic (Foot and Cycle Paths)

Power Led: 78W - 2x8243 lm ≠ OUTPUT 2x6261 lm - 2700K/CRI 80 - 220÷240V / 78W - 2x8832 lm ≠ OUTPUT 2x6708 lm - 3000K/CRI 80 - 220÷240V / 78W - 2x9126 lm ≠ OUTPUT 2x6932 lm - 4000K/CRI 80 - 220÷240V

2700K

- Non Dimmable
- FA53911206
 - FA53911233
- 1-10V
- FA53911206-310
 - FA53911233-310
- Dali
- FA53911206-300
 - FA53911233-300

3000K

- Non Dimmable
- FA53901806
 - FA53901833
- 1-10V
- FA53901806-310
 - FA53901833-310
- Dali
- FA53901806-300
 - FA53901833-300

4000K

- Non Dimmable
- FA53901706
 - FA53901733
- 1-10V
- FA53901706-310
 - FA53901733-310
- Dali
- FA53901706-300
 - FA53901733-300

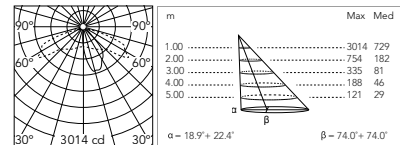
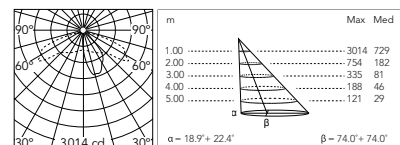

@ 3000K

Dooku 600 - Single Top Pole ø102

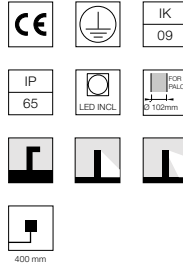
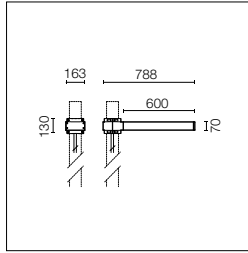

Sorgente a LED inclusa. Alimentazione elettrica 220-240V ON/OFF e dimmerabile 1-10V o DALI integrata. Staffa di fissaggio inclusa. Dotato di spezzone di cavo uscente in neoprene 400 mm e connettore IP68. Attacco singolo per pali diametro 102mm, palo da ordinare separatamente. Versione Smart- City a richiesta.

LED source included. Integrated power supply 220-240V ON/OFF and dimmable 1-10V or DALI. Fixing bracket included. Equipped with a 400mm protruding neoprene cable section and IP68 connectors. Smart-City version available upon request. Single socket for 102mm diameter post. The post must be ordered separately. Smart-City version available upon request.

2200K disponibile su richiesta.

2200K available on request.

Optic 120° (Wide Spaces - Public Areas - Parking Areas)

Power Led: 78W - 8243 lm ≠ OUTPUT 6779 lm - 2700K/CRI 80 - 220÷240V / 78W - 8832 lm ≠ OUTPUT 7263 lm - 3000K/CRI 80 - 220÷240V / 78W - 9126 lm ≠ OUTPUT 7505 lm - 4000K/CRI 80 - 220÷240V

2700K

Non Dimmable

- FA53911406
- FA53911433
- 1-10V
- FA53911406-310
- FA53911433-310
- Dali
- FA53911406-300
- FA53911433-300

3000K

Non Dimmable

- FA53902106
- FA53902133
- 1-10V
- FA53902106-310
- FA53902133-310
- Dali
- FA53902106-300
- FA53902133-300

4000K

Non Dimmable

- FA53902006
- FA53902033
- 1-10V
- FA53902006-310
- FA53902033-310
- Dali
- FA53902006-300
- FA53902033-300

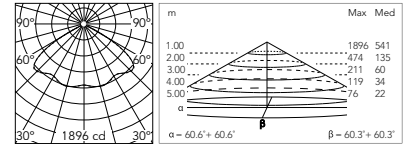

@ 3000K

Asymmetric Optic

Power Led: 78W - 8243 lm ≠ OUTPUT 6347 lm - 2700K/CRI 80 - 220÷240V / 78W - 8832 lm ≠ OUTPUT 6800 lm - 3000K/CRI 80 - 220÷240V / 78W - 9126 lm ≠ OUTPUT 7027 lm - 4000K/CRI 80 - 220÷240V

2700K

Non Dimmable

- FA53914406
- FA53914433
- 1-10V
- FA53914406-310
- FA53914433-310
- Dali
- FA53914406-300
- FA53914433-300

3000K

Non Dimmable

- FA53916206
- FA53916233
- 1-10V
- FA53916206-310
- FA53916233-310
- Dali
- FA53916206-300
- FA53916233-300

4000K

Non Dimmable

- FA53918006
- FA53918033
- 1-10V
- FA53918006-310
- FA53918033-310
- Dali
- FA53918006-300
- FA53918033-300

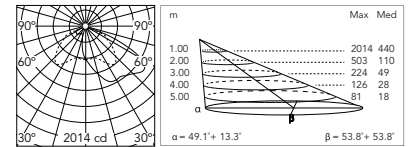

@ 3000K

Street Light Optic

Power Led: 78W - 8243 lm ≠ OUTPUT 6203 lm - 2700K/CRI 80 - 220÷240V / 78W - 8832 lm ≠ OUTPUT 6646 lm - 3000K/CRI 80 - 220÷240V / 78W - 9126 lm ≠ OUTPUT 6868 lm - 4000K/CRI 80 - 220÷240V

2700K

Non Dimmable

- FA53911606
- FA53911633
- 1-10V
- FA53911606-310
- FA53911633-310
- Dali
- FA53911606-300
- FA53911633-300

3000K

Non Dimmable

- FA53902406
- FA53902433
- 1-10V
- FA53902406-310
- FA53902433-310
- Dali
- FA53902406-300
- FA53902433-300

4000K

Non Dimmable

- FA53902306
- FA53902333
- 1-10V
- FA53902306-310
- FA53902333-310
- Dali
- FA53902306-300
- FA53902333-300

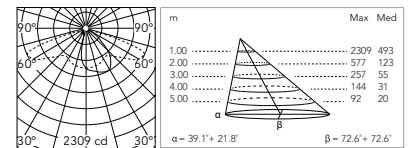

@ 3000K

Street Light Optic (Foot and Cycle Paths)

Power Led: 78W - 8243 lm ≠ OUTPUT 6261 lm - 2700K/CRI 80 - 220÷240V / 78W - 8832 lm ≠ OUTPUT 6708 lm - 3000K/CRI 80 - 220÷240V / 78W - 9126 lm ≠ OUTPUT 6932 lm - 4000K/CRI 80 - 220÷240V

2700K

Non Dimmable

- FA53911806
- FA53911833
- 1-10V
- FA53911806-310
- FA53911833-310
- Dali
- FA53911806-300
- FA53911833-300

3000K

Non Dimmable

- FA53902706
- FA53902733
- 1-10V
- FA53902706-310
- FA53902733-310
- Dali
- FA53902706-300
- FA53902733-300

4000K

Non Dimmable

- FA53902606
- FA53902633
- 1-10V
- FA53902606-310
- FA53902633-310
- Dali
- FA53902606-300
- FA53902633-300

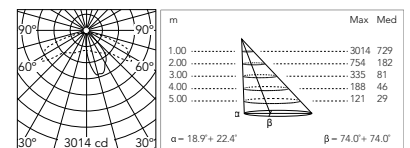

@ 3000K

Dooku 600 - Double Top Pole ø102

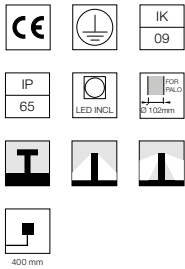
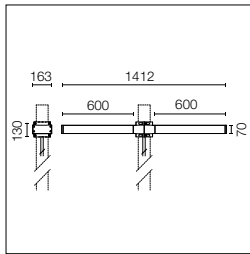

Sorgente a LED inclusa. Alimentazione elettrica 220-240V ON/OFF e dimmerabile 1-10V o DALI integrata. Staffa di fissaggio inclusa. Dotato di spezzone di cavo uscente in neoprene 400 mm e connettore IP68. Attacco doppio per pali diametro 102 mm, palo da ordinare separatamente. Versione Smart-City a richiesta.

LED source included. Integrated power supply 220-240V ON/OFF and dimmable 1-10V or DALI. Fixing bracket included. Equipped with a 400mm protruding neoprene cable section and IP68 connectors. Double socket for 102mm diameter post. The post must be ordered separately. Smart-City version available upon request.

2200K disponibile su richiesta.

2200K available on request.

Optic 120° (Wide Spaces - Public Areas - Parking Areas)

Power Led: 78W - 2x8243 lm ≠ OUTPUT 2x6779 lm - 2700K/CRI 80 - 220÷240V / 78W - 2x8832 lm ≠ OUTPUT 2x7263 lm - 3000K/CRI 80 - 220÷240V / 78W - 2x9126 lm ≠ OUTPUT 2x7505 lm - 4000K/CRI 80 - 220÷240V

2700K

- Non Dimmable
- FA53912006
 - FA53912033
- 1-10V
- FA53912006-310
 - FA53912033-310
- Dali
- FA53912006-300
 - FA53912033-300

3000K

- Non Dimmable
- FA53903006
 - FA53903033
- 1-10V
- FA53903006-310
 - FA53903033-310
- Dali
- FA53903006-300
 - FA53903033-300

4000K

- Non Dimmable
- FA53902906
 - FA53902933
- 1-10V
- FA53902906-310
 - FA53902933-310
- Dali
- FA53902906-300
 - FA53902933-300

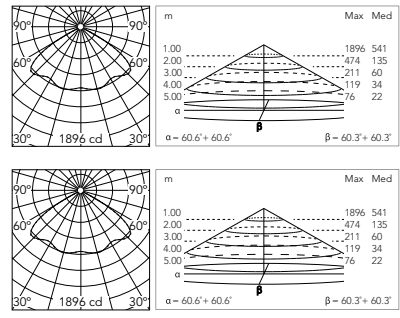

@ 3000K

Asymmetric Optic

Power Led: 78W - 2x8243 lm ≠ OUTPUT 2x6347 lm - 2700K/CRI 80 - 220÷240V / 78W - 2x8832 lm ≠ OUTPUT 2x6800 lm - 3000K/CRI 80 - 220÷240V / 78W - 2x9126 lm ≠ OUTPUT 2x7027 lm - 4000K/CRI 80 - 220÷240V

2700K

- Non Dimmable
- FA53914606
 - FA53914633
- 1-10V
- FA53914606-310
 - FA53914633-310
- Dali
- FA53914606-300
 - FA53914633-300

3000K

- Non Dimmable
- FA53916406
 - FA53916433
- 1-10V
- FA53916406-310
 - FA53916433-310
- Dali
- FA53916406-300
 - FA53916433-300

4000K

- Non Dimmable
- FA53918206
 - FA53918233
- 1-10V
- FA53918206-310
 - FA53918233-310
- Dali
- FA53918206-300
 - FA53918233-300

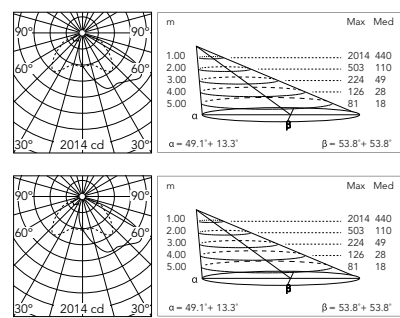

@ 3000K

Street Light Optic

Power Led: 78W - 2x8243 lm ≠ OUTPUT 2x6203 lm - 2700K/CRI 80 - 220÷240V / 78W - 2x8832 lm ≠ OUTPUT 2x6646 lm - 3000K/CRI 80 - 220÷240V / 78W - 2x9126 lm ≠ OUTPUT 2x6868 lm - 4000K/CRI 80 - 220÷240V

2700K

- Non Dimmable
- FA53912206
 - FA53912233
- 1-10V
- FA53912206-310
 - FA53912233-310
- Dali
- FA53912206-300
 - FA53912233-300

3000K

- Non Dimmable
- FA53903306
 - FA53903333
- 1-10V
- FA53903306-310
 - FA53903333-310
- Dali
- FA53903306-300
 - FA53903333-300

4000K

- Non Dimmable
- FA53903206
 - FA53903233
- 1-10V
- FA53903206-310
 - FA53903233-310
- Dali
- FA53903206-300
 - FA53903233-300

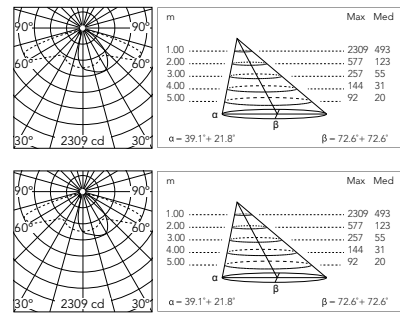

@ 3000K

Street Light Optic (Foot and Cycle Paths)

Power Led: 78W - 2x8243 lm ≠ OUTPUT 2x6261 lm - 2700K/CRI 80 - 220÷240V / 78W - 2x8832 lm ≠ OUTPUT 2x6708 lm - 3000K/CRI 80 - 220÷240V / 78W - 2x9126 lm ≠ OUTPUT 2x6932 lm - 4000K/CRI 80 - 220÷240V

2700K

- Non Dimmable
- FA53912406
 - FA53912433
- 1-10V
- FA53912406-310
 - FA53912433-310
- Dali
- FA53912406-300
 - FA53912433-300

3000K

- Non Dimmable
- FA53903606
 - FA53903633
- 1-10V
- FA53903606-310
 - FA53903633-310
- Dali
- FA53903606-300
 - FA53903633-300

4000K

- Non Dimmable
- FA53903506
 - FA53903533
- 1-10V
- FA53903506-310
 - FA53903533-310
- Dali
- FA53903506-300
 - FA53903533-300

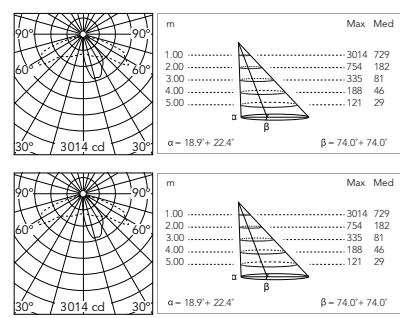

@ 3000K

Dooku / Ø 76mm - Poles

Con Base e Portella con Morsettiera.

With Base and Access Door .
With Terminal Block 4x1,5-16mmq.



H 3500mm

- FA24806
- FA24833

H 4500mm

- FA24906
- FA24933

Da Interrare (+500 mm Interrati) e Portella con Morsettiera

In-Ground (+500 mm Root) With Access Door
With Terminal Block 4x1,5-16mmq



H 3500mm

- FA25006
- FA25033

H 4500mm

- FA25106
- FA25133

Dooku / Ø 102mm - Poles

Con Base e Portella con Morsettiera.

With Base and Access Door .
With Terminal Block 4x1,5-16mmq.



H 4000mm

- FA414006
- FA414033

H 5000mm

- FA415006
- FA415033

Da Interrare (+500 mm Interrati) e Portella con Morsettiera

In-Ground (+500 mm Root) With Access Door
With Terminal Block 4x1,5-16mmq

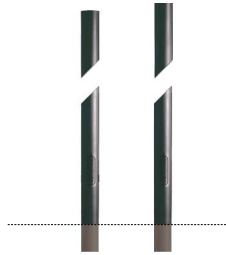

H 4000mm

- FA414506
- FA414533

H 5000mm

- FA415506
- FA415533

Dooku: Accessori / Accessories

Piastra tirafondi.

Base plate with bolt.

FA116

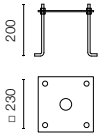

Dispositivo di protezione per il sovraccarico. 275Vac. Corrente massima di scarica 10KA (8/29µs). Massima corrente operativa 5A. Adatto per la connessione in serie. IP66.

Surge protection device. 275Vac. Maximum discharge current 10KA (8/20µs). Maximum operating current 5A. Suitable for series connection. IP66.

F990E00A000

