



Gobi

ITALIANO / ENGLISH

FLOS

Outdoor

Gobi



Gobi





Famiglia / Family

Gobi 180



Power Led

up to 12W
up to 256 lm - 2700K/CRI 80
up to 276 lm - 3000K/CRI 80
up to 296 lm - 4000K/CRI 80

* Net lumen output

2200K available on request.

Gobi 130



Power Led

up to 7W
up to 140 lm - 2700K/CRI 80
up to 152 lm - 3000K/CRI 80
up to 164 lm - 4000K/CRI 80

* Net lumen output

2200K available on request.

Gobi 65



Power Led

up to 3,4W
up to 60 lm - 2700K/CRI 80
up to 64 lm - 3000K/CRI 80
up to 72 lm - 4000K/CRI 80

* Net lumen output

2200K available on request.

Gobi 65 Wall Path



Power Led

up to 3,4W
up to 47 lm - 2700K/CRI 80
up to 50 lm - 3000K/CRI 80
up to 54 lm - 4000K/CRI 80

* Net lumen output

2200K available on request.

Gobi 49



Power Led

up to 2,3W
up to 40 lm - 2700K/CRI 80
up to 44 lm - 3000K/CRI 80
up to 48 lm - 4000K/CRI 80

* Net lumen output

2200K available on request.

Gobi 49 Wall Path



Power Led

up to 2,3W
up to 36 lm - 2700K/CRI 80
up to 39 lm - 3000K/CRI 80
up to 42 lm - 4000K/CRI 80

* Net lumen output

2200K available on request.

Colori / Colours



01 White



06 Grey



12 Forest Green



18 Deep Brown



30 Black



33 Anthracite

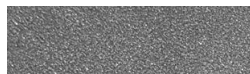

56 Matt Stainless Steel*

* Solo per versioni Gobi 65 e Gobi 49. / Only for Gobi 65 and Gobi 49 versions.

Descrizione / Description

Famiglia completa di apparecchi segnapasso ad incasso a pavimento con sorgente luminosa a LED ad emissione radente. Disponibili in differenti tagli dimensionali e molteplici fasci di apertura direzionati. Le viterie di fissaggio sono in acciaio inox AISI 316L. L'installazione richiede una cassaforma da incasso da ordinare separatamente. È necessario garantire un livello adeguato di materiale drenante sotto la cassaforma o fornire un sistema di scarico per evitare il ristagno di acqua. Per garantire la tenuta del pressacavo è necessario utilizzare cavi elettrici flessibili idonei all'impiego in ambienti esterni.

Gobi

Apparecchio ad incasso a terra calpestabile e carrabile, disponibile in due dimensioni di diametro e in tre fasci di apertura: monodirezionale, bidirezionale e omnidirezionale. La posizione parallela della sorgente luminosa alla superficie di appoggio permette di sfruttare al massimo la componente diretta dell'emissione luminosa. Corpo dell'apparecchio e dissipatore realizzato in alluminio pressofuso EN AB-47100 a basso contenuto di rame, rivestito con doppio strato di vernice ad alta resistenza alla corrosione. Vetro borosilicato trasparente. L'apparecchio è dotato di un connettore a vite M12 a tenuta stagna che fornisce isolamento ottimale contro la penetrazione di acqua e rapido collegamento con l'unità di cablaggio. Nella versione a 230V l'alimentatore è in dotazione con l'apparecchio come un kit IP66/67 remoto da alloggiare nella cassaforma da incasso, nella versione a 24V dc è provvisto di uno spezzone di cavo con connettore a vite per il collegamento elettrico all'alimentatore remoto. Disponibili due versioni di casseforme, la versione standard in materiale plastico e la versione in metallo ad alta resistenza per aree ad alto flusso veicolare.

Gobi 49 / Gobi 65

Apparecchi ad incasso a terra calpestabili, disponibili in due dimensioni di diametro e in quattro fasci di apertura: un fascio, due fasci, tre fasci e quattro fasci. Corpo dell'apparecchio in alluminio tornito lega EN AW 6060 con trattamento di anodizzazione ad alta resistenza alla corrosione. Cover esterna in acciaio inox AISI 316L pallinato. Diffusore in policarbonato trasparente. Apparecchio in 24V dc, necessita di alimentatore remoto da ordinare separatamente.

Gobi 49 Wall / Gobi 65 Wall

Apparecchi ad incasso a parete segnapasso, disponibili in due dimensioni di diametro e con fascio di apertura 180° direzionato verso il pavimento. Corpo dell'apparecchio in alluminio tornito lega EN AW 6060 con trattamento di anodizzazione ad alta resistenza alla corrosione. Cover esterna in acciaio inox AISI 316L pallinato. Diffusore in policarbonato trasparente. Apparecchio in 24V dc, necessita di alimentatore remoto da ordinare separatamente.

Complete family of ground-recessed path lights, with flush-emitting LED source. Available in different dimensions and several adjustable beam angles. The fixing screws are made of AISI 316L stainless steel. Requires a specific junction box to be ordered separately. To avoid water stagnation, it is necessary to insulate the lower part of the box with a layer of drainage material or other drainage system. In order to guarantee the preservation of the cable guide, it is recommended to use flexible electric cables specifically designed for outdoor use.

Gobi

Ground recessed and walk-over luminaire, available in two different diameters and three beam angles: monodirectional, bidirectional and omnidirectional. The position of the light source, parallel to the supporting surface, allows the direct component of the light emission to be exploited to the maximum. EN AB-47100 die-cast aluminium body (with low copper content), coated with a double layer of highly corrosion-resistant paint. Transparent borosilicate glass. Equipped with an M12 screw-on connector that prevents water infiltration and guarantees a quick connection to the wiring unit. 230V versions include the power supply unit and a remote IP66/67 kit to be installed in the junction box for recessing. The 24 V dc version is equipped with a cable and a screw connector for the connection to the remote power supply. The junction box is available in two versions: the standard version made of plastic and the heavy duty metal version, suitable for areas with high vehicular flow.

Gobi 49 / Gobi 65

Ground recessed and walk-over luminaire, available in two different diameters and four beam angles: one beam, two beams, three beams and four beams. Structure in turned aluminium, EN AW 6060 alloy, with an anodized treatment for better resistance to corrosion. The external structure is covered in AISI 316L shot-blasted stainless steel. Transparent polycarbonate diffuser. The 24 V dc luminaire is powered by a remote power supply to be ordered separately.

Gobi 49 Wall / Gobi 65 Wall

Wall-recessed path light, available in two different diameters and with a 180° beam angle directed towards the floor. Structure in turned aluminium, EN AW 6060 alloy, with an anodized treatment for better resistance to corrosion. The external structure is covered in AISI 316L shot-blasted stainless steel. Transparent polycarbonate diffuser. The 24 V dc luminaire is powered by a remote power supply to be ordered separately.

Gobi 180 Mono

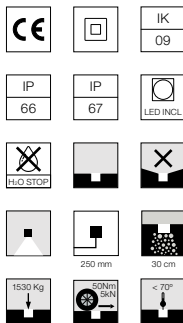
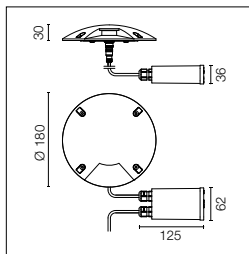

Sorgente a LED inclusa.
Alimentazione elettrica 220-240V ON/ OFF integrata.
Necessaria cassaforma da ordinare separatamente.
Alimentatore dotato di spezzone di cavo di 400mm con connettore a vite M12 a tenuta stagna verso l'apparecchio e spezzone di cavo di 300mm per collegamento alla linea elettrica.
Versione dimmerabile a richiesta.

LED light source included.
Integrated electric power supply 220-240V ON/OFF.
Requires a junction box to be ordered separately.
The luminaire is equipped with a protruding, neoprene, 400 mm cable with an M12 watertight screw-on connector towards the luminaire, and with a 300 mm cable for the connection to the power line.
Adjustable light intensity version available upon request.

2200K disponibile su richiesta.

2200K available on request.

Power Led: 5W - 233 lm \neq OUTPUT 64 lm - 2700K/CRI 80 - 220 \div 240V / 5W - 250 lm \neq OUTPUT 69 lm - 3000K/CRI 80 - 220 \div 240V / 5W - 266 lm \neq OUTPUT 74 lm - 4000K/CRI 80 - 220 \div 240V

2700K

- FA53504701
- FA53504706
- FA53504712
- FA53504718
- FA53504730
- FA53504733

3000K

- FA53501201
- FA53501206
- FA53501212
- FA53501218
- FA53501230
- FA53501233

4000K

- FA53501101
- FA53501106
- FA53501112
- FA53501118
- FA53501130
- FA53501133

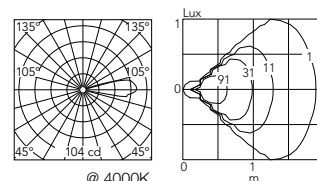

Gobi 180 Mono Low Voltage

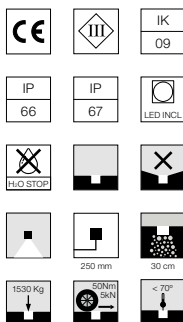
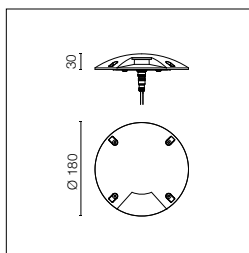

Sorgente a LED inclusa.
Alimentazione elettrica remota 24Vdc da ordinare separatamente. Necessaria cassaforma da ordinare separatamente. Dotato di spezzone di cavo 250mm con connettore a vite M12 a tenuta stagna. Accessori opzionali: cavo 5000mm e cavo splitter 300mm con connettori M12 per installazioni multiple.

LED source included. 24V dc remote electric power supply to be ordered separately. Requires a junction box to be ordered separately. The luminaire is equipped with protruding, 250 mm cable with an M12 watertight screw-on connector. Optional accessories: 5000 mm cable and 300 mm splitter cable with M12 connectors for multiple installations.

2200K disponibile su richiesta.

2200K available on request.

Power Led: 3,4W - 233 lm \neq OUTPUT 64 lm - 2700K/CRI 80 - 24Vdc / 3,4W - 250 lm \neq OUTPUT 69 lm - 3000K/CRI 80 - 24Vdc / 3,4W - 266 lm \neq OUTPUT 74 lm - 4000K/CRI 80 - 24Vdc

2700K

- FA53504801
- FA53504806
- FA53504812
- FA53504818
- FA53504830
- FA53504833

3000K

- FA53503001
- FA53503006
- FA53503012
- FA53503018
- FA53503030
- FA53503033

4000K

- FA53502901
- FA53502906
- FA53502912
- FA53502918
- FA53502930
- FA53502933

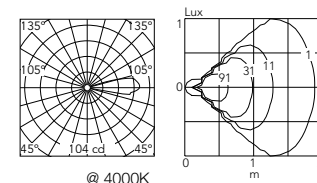

* Numero massimo di apparecchi per alimentatore / Maximum number of luminaires per power supply.

Numero massimo di apparecchi per alimentatore (Vin220 \div 240). Dati indicativi da verificare con le specifiche condizioni di installazione.

Maximum number of luminaires per power supply. (220 \div 240 V). These data must be checked taking into account the specific installation conditions.

Acc. RF25752	3
Acc. F990B28A000	8
Acc. F990B27A000	16

Gobi 130 Mono

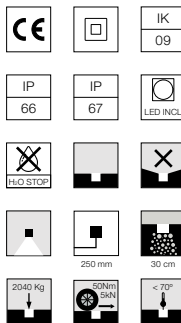
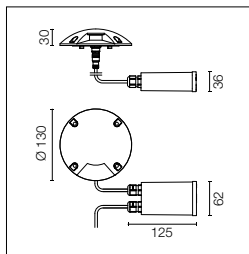

Sorgente a LED inclusa. Alimentazione elettrica 220-240V ON/ OFF integrata. Necessaria cassaforma da ordinare separatamente. Alimentatore dotato di spezzone di cavo di 400mm con connettore a vite M12 a tenuta stagna verso l'apparecchio e spezzone di cavo di 300mm per collegamento alla linea elettrica. Versione dimmerabile a richiesta.

LED light source included. Integrated electric power supply 220-240V ON/OFF. Requires a junction box to be ordered separately. The luminaire is equipped with a protruding, neoprene, 400 mm cable with an M12 watertight screw-on connector towards the luminaire, and with a 300 mm cable for the connection to the power line. Adjustable light intensity version available upon request.

2200K disponibile su richiesta.

2200K available on request.

Power Led: 4W - 129 lm ≠ OUTPUT 35 lm - 2700K/CRI 80 - 220÷240V / 4W - 139 lm ≠ OUTPUT 38 lm - 3000K/CRI 80 - 220÷240V / 4W - 148 lm ≠ OUTPUT 41 lm - 4000K/CRI 80 - 220÷240V

2700K

- FA53504101
- FA53504106
- FA53504112
- FA53504118
- FA53504130
- FA53504133

3000K

- FA53500301
- FA53500306
- FA53500312
- FA53500318
- FA53500330
- FA53500333

4000K

- FA53500201
- FA53500206
- FA53500212
- FA53500218
- FA53500230
- FA53500233

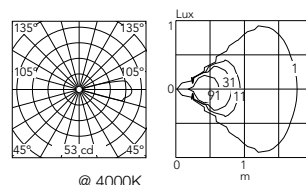

Gobi 130 Mono Low Voltage

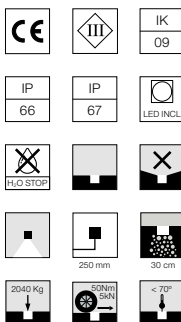
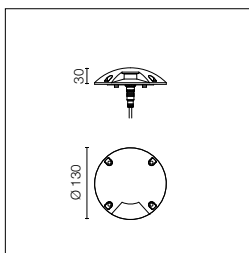

Sorgente a LED inclusa. Alimentazione elettrica remota 24Vdc da ordinare separatamente. Necessaria cassaforma da ordinare separatamente. Dotato di spezzone di cavo 250mm con connettore a vite M12 a tenuta stagna. Accessori opzionali: cavo 5000mm e cavo splitter 300mm con connettori M12 per installazioni multiple.

LED source included. 24V dc remote electric power supply to be ordered separately. Requires a junction box to be ordered separately. The luminaire is equipped with protruding, 250 mm cable with an M12 watertight screw-on connector. Optional accessories: 5000 mm cable and 300 mm splitter cable with M12 connectors for multiple installations.

2200K disponibile su richiesta.

2200K available on request.

Power Led: 1,9W - 129 lm ≠ OUTPUT 35 lm - 2700K/CRI 80 - 24Vdc / 1,9W - 139 lm ≠ OUTPUT 38 lm - 3000K/CRI 80 - 24Vdc / 1,9W - 148 lm ≠ OUTPUT 41 lm - 4000K/CRI 80 - 24Vdc

2700K

- FA53504201
- FA53504206
- FA53504212
- FA53504218
- FA53504230
- FA53504233

3000K

- FA53502101
- FA53502106
- FA53502112
- FA53502118
- FA53502130
- FA53502133

4000K

- FA53502001
- FA53502006
- FA53502012
- FA53502018
- FA53502030
- FA53502033

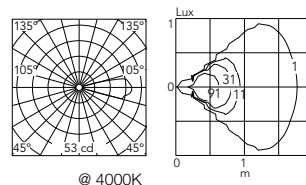

* Numero massimo di apparecchi per alimentatore / Maximum number of luminaires per power supply.

Numero massimo di apparecchi per alimentatore (Vin220÷240). Dati indicativi da verificare con le specifiche condizioni di installazione.

Maximum number of luminaires per power supply. (220÷240 V). These data must be checked taking into account the specific installation conditions.

Acc. RF25752	5
Acc. F990B28A000	16
Acc. F990B27A000	33

Gobi 180 Double

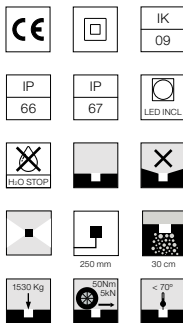
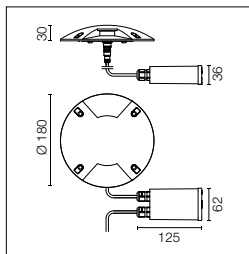

Sorgente a LED inclusa.
Alimentazione elettrica 220-240V ON/ OFF integrata.
Necessaria cassaforma da ordinare separatamente.
Alimentatore dotato di spezzone di cavo di 400mm con connettore a vite M12 a tenuta stagna verso l'apparecchio e spezzone di cavo di 300mm per collegamento alla linea elettrica.
Versione dimmerabile a richiesta.

LED light source included.
Integrated electric power supply 220-240V ON/OFF.
Requires a junction box to be ordered separately.
The luminaire is equipped with a protruding, neoprene, 400 mm cable with an M12 watertight screw-on connector towards the luminaire, and with a 300 mm cable for the connection to the power line.
Adjustable light intensity version available upon request.

2200K disponibile su richiesta.

2200K available on request.

Power Led: 7W - 2x233 lm \neq OUTPUT 2x64 lm - 2700K/CRI 80 - 220 \div 240V / 7W - 2x250 lm \neq OUTPUT 2x69 lm - 3000K/CRI 80 - 220 \div 240V / 7W - 2x266 lm \neq OUTPUT 2x74 lm - 4000K/CRI 80 - 220 \div 240V

2700K

- FA53504901
- FA53504906
- FA53504912
- FA53504918
- FA53504930
- FA53504933

3000K

- FA53501501
- FA53501506
- FA53501512
- FA53501518
- FA53501530
- FA53501533

4000K

- FA53501401
- FA53501406
- FA53501412
- FA53501418
- FA53501430
- FA53501433

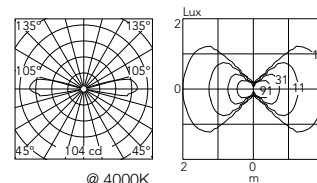

Gobi 180 Double Low Voltage

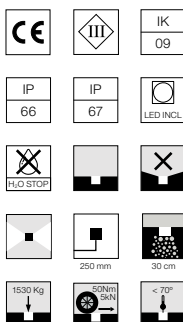
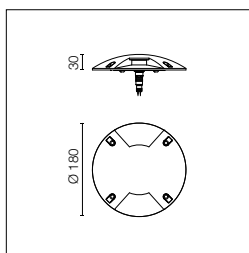

Sorgente a LED inclusa.
Alimentazione elettrica remota 24Vdc da ordinare separatamente. Necessaria cassaforma da ordinare separatamente. Dotato di spezzone di cavo 250mm con connettore a vite M12 a tenuta stagna. Accessori opzionali: cavo 5000mm e cavo splitter 300mm con connettori M12 per installazioni multiple.

LED source included. 24V dc remote electric power supply to be ordered separately. Requires a junction box to be ordered separately. The luminaire is equipped with protruding, 250 mm cable with an M12 watertight screw-on connector. Optional accessories: 5000 mm cable and 300 mm splitter cable with M12 connectors for multiple installations.

2200K disponibile su richiesta.

2200K available on request.

Power Led: 6,4W - 2x233 lm \neq OUTPUT 2x64 lm - 2700K/CRI 80 - 24Vdc / 6,4W - 2x250 lm \neq OUTPUT 2x69 lm - 3000K/CRI 80 - 24Vdc / 6,4W - 2x266 lm \neq OUTPUT 2x74 lm - 4000K/CRI 80 - 24Vdc

2700K

- FA53505001
- FA53505006
- FA53505012
- FA53505018
- FA53505030
- FA53505033

3000K

- FA53503301
- FA53503306
- FA53503312
- FA53503318
- FA53503330
- FA53503333

4000K

- FA53503201
- FA53503206
- FA53503212
- FA53503218
- FA53503230
- FA53503233

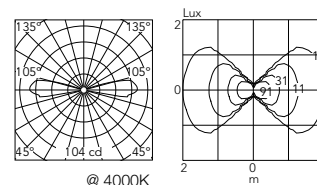

* Numero massimo di apparecchi per alimentatore / Maximum number of luminaires per power supply.

Numero massimo di apparecchi per alimentatore (Vin220 \div 240). Dati indicativi da verificare con le specifiche condizioni di installazione.

Maximum number of luminaires per power supply. (220 \div 240 V). These data must be checked taking into account the specific installation conditions.

Acc. RF25752	2
Acc. F990B28A000	5
Acc. F990B27A000	8

Gobi 130 Double

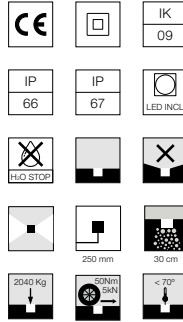
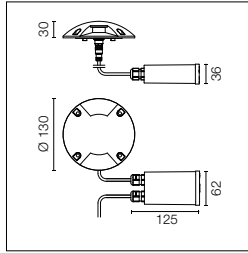

Sorgente a LED inclusa. Alimentazione elettrica 220-240V ON/ OFF integrata. Necessaria cassaforma da ordinare separatamente. Alimentatore dotato di spezzone di cavo di 400mm con connettore a vite M12 a tenuta stagna verso l'apparecchio e spezzone di cavo di 300mm per collegamento alla linea elettrica. Versione dimmerabile a richiesta.

LED light source included. Integrated electric power supply 220-240V ON/OFF. Requires a junction box to be ordered separately. The luminaire is equipped with a protruding, neoprene, 400 mm cable with an M12 watertight screw-on connector towards the luminaire, and with a 300 mm cable for the connection to the power line. Adjustable light intensity version available upon request.

2200K disponibile su richiesta.

2200K available on request.

Power Led: 5W - 2x129 lm ≠ OUTPUT 2x35 lm - 2700K/CRI 80 - 220÷240V / 5W - 2x139 lm ≠ OUTPUT 2x38 lm - 3000K/CRI 80 - 220÷240V / 5W - 2x148 lm ≠ OUTPUT 2x41 lm - 4000K/CRI 80 - 220÷240V

2700K

- FA53504301
- FA53504306
- FA53504312
- FA53504318
- FA53504330
- FA53504333

3000K

- FA53500601
- FA53500606
- FA53500612
- FA53500618
- FA53500630
- FA53500633

4000K

- FA53500501
- FA53500506
- FA53500512
- FA53500518
- FA53500530
- FA53500533

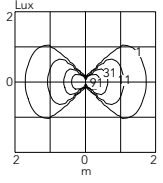
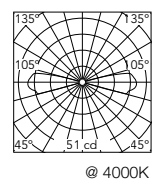

Gobi 130 Double Low Voltage

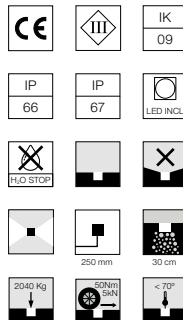
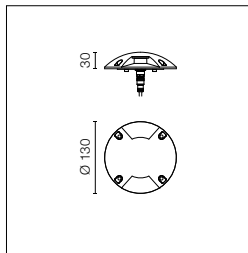

Sorgente a LED inclusa. Alimentazione elettrica remota 24Vdc da ordinare separatamente. Necessaria cassaforma da ordinare separatamente. Dotato di spezzone di cavo 250mm con connettore a vite M12 a tenuta stagna. Accessori opzionali: cavo 5000mm e cavo splitter 300mm con connettori M12 per installazioni multiple.

LED source included. 24V dc remote electric power supply to be ordered separately. Requires a junction box to be ordered separately. The luminaire is equipped with protruding, 250 mm cable with an M12 watertight screw-on connector. Optional accessories: 5000 mm cable and 300 mm splitter cable with M12 connectors for multiple installations.

2200K disponibile su richiesta.

2200K available on request.

Power Led: 3,5W - 2x129 lm ≠ OUTPUT 2x35 lm - 2700K/CRI 80 - 24Vdc / 3,5W - 2x139 lm ≠ OUTPUT 2x38 lm - 3000K/CRI 80 - 24Vdc / 3,5W - 2x148 lm ≠ OUTPUT 2x41 lm - 4000K/CRI 80 - 24Vdc

2700K

- FA53504401
- FA53504406
- FA53504412
- FA53504418
- FA53504430
- FA53504433

3000K

- FA53502401
- FA53502406
- FA53502412
- FA53502418
- FA53502430
- FA53502433

4000K

- FA53502301
- FA53502306
- FA53502312
- FA53502318
- FA53502330
- FA53502333

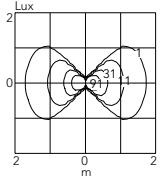
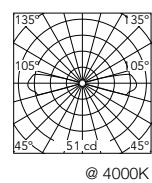

* Numero massimo di apparecchi per alimentatore / Maximum number of luminaires per power supply.

Numero massimo di apparecchi per alimentatore (Vin220÷240). Dati indicativi da verificare con le specifiche condizioni di installazione.

Maximum number of luminaires per power supply. (220÷240 V). These data must be checked taking into account the specific installation conditions.

Acc. RF25752	2
Acc. F990B28A000	10
Acc. F990B27A000	19

Gobi 180 Multi

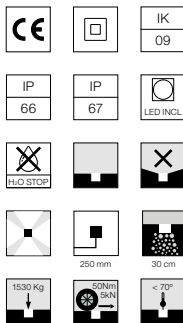
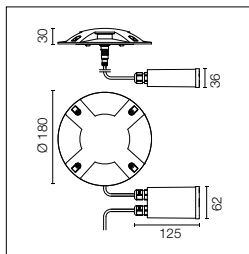

Sorgente a LED inclusa. Alimentazione elettrica 220-240V ON/ OFF integrata. Necessaria cassaforma da ordinare separatamente. Alimentatore dotato di spezzone di cavo di 400mm con connettore a vite M12 a tenuta stagna verso l'apparecchio e spezzone di cavo di 300mm per collegamento alla linea elettrica. Versione dimmerabile a richiesta.

LED light source included. Integrated electric power supply 220-240V ON/OFF. Requires a junction box to be ordered separately. The luminaire is equipped with a protruding, neoprene, 400 mm cable with an M12 watertight screw-on connector towards the luminaire, and with a 300 mm cable for the connection to the power line. Adjustable light intensity version available upon request.

2200K disponibile su richiesta.

2200K available on request.

Power Led: 12W - 4x233 lm \neq OUTPUT 4x64 lm - 2700K/CRI 80 - 220 \div 240V / 12W - 4x250 lm \neq OUTPUT 4x69 lm - 3000K/CRI 80 - 220 \div 240V / 12W - 4x266 lm \neq OUTPUT 4x74 lm - 4000K/CRI 80 - 220 \div 240V

2700K

- FA53505101
- FA53505106
- FA53505112
- FA53505118
- FA53505130
- FA53505133

3000K

- FA53501801
- FA53501806
- FA53501812
- FA53501818
- FA53501830
- FA53501833

4000K

- FA53501701
- FA53501706
- FA53501712
- FA53501718
- FA53501730
- FA53501733

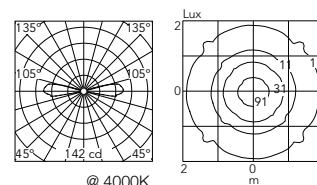

Gobi 180 Multi Low Voltage

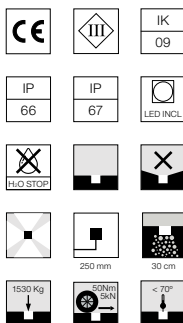
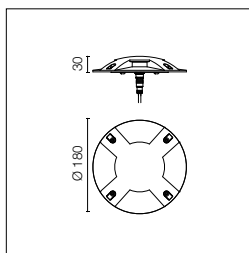

Sorgente a LED inclusa. Alimentazione elettrica remota 24Vdc da ordinare separatamente. Necessaria cassaforma da ordinare separatamente. Dotato di spezzone di cavo 250mm con connettore a vite M12 a tenuta stagna. Accessori opzionali: cavo 5000mm e cavo splitter 300mm con connettori M12 per installazioni multiple.

LED source included. 24V dc remote electric power supply to be ordered separately. Requires a junction box to be ordered separately. The luminaire is equipped with protruding, 250 mm cable with an M12 watertight screw-on connector. Optional accessories: 5000 mm cable and 300 mm splitter cable with M12 connectors for multiple installations.

2200K disponibile su richiesta.

2200K available on request.

Power Led: 11,2W - 4x233 lm \neq OUTPUT 4x64 lm - 2700K/CRI 80 - 24Vdc / 11,2W - 4x250 lm \neq OUTPUT 4x69 lm - 3000K/CRI 80 - 24Vdc / 11,2W - 4x266 lm \neq OUTPUT 4x74 lm - 4000K/CRI 80 - 24Vdc

2700K

- FA53505201
- FA53505206
- FA53505212
- FA53505218
- FA53505230
- FA53505233

3000K

- FA53503601
- FA53503606
- FA53503612
- FA53503618
- FA53503630
- FA53503633

4000K

- FA53503501
- FA53503506
- FA53503512
- FA53503518
- FA53503530
- FA53503533

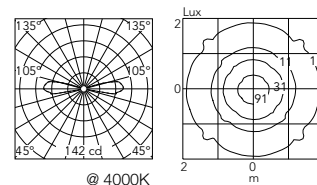

* Numero massimo di apparecchi per alimentatore / Maximum number of luminaires per power supply.

Numero massimo di apparecchi per alimentatore (Vin220÷240). Dati indicativi da verificare con le specifiche condizioni di installazione.

Maximum number of luminaires per power supply. (220÷240 V). These data must be checked taking into account the specific installation conditions.

Acc. RF25752 1
Acc. F990B28A000 3
Acc. F990B27A000 6

Gobi 130 Multi

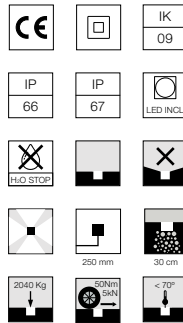
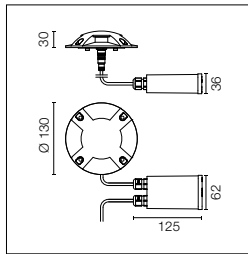

Sorgente a LED inclusa. Alimentazione elettrica 220-240V ON/ OFF integrata. Necessaria cassaforma da ordinare separatamente. Alimentatore dotato di spezzone di cavo di 400mm con connettore a vite M12 a tenuta stagna verso l'apparecchio e spezzone di cavo di 300mm per collegamento alla linea elettrica. Versione dimmerabile a richiesta.

LED light source included. Integrated electric power supply 220-240V ON/OFF. Requires a junction box to be ordered separately. The luminaire is equipped with a protruding, neoprene, 400 mm cable with an M12 watertight screw-on connector towards the luminaire, and with a 300 mm cable for the connection to the power line. Adjustable light intensity version available upon request.

2200K disponibile su richiesta.

2200K available on request.

Power Led: 7W - 4x129 lm ≠ OUTPUT 4x35 lm - 2700K/CRI 80 - 220÷240V / 7W - 4x139 lm ≠ OUTPUT 4x38 lm - 3000K/CRI 80 - 220÷240V / 7W - 4x148 lm ≠ OUTPUT 4x41 lm - 4000K/CRI 80 - 220÷240V

2700K

- FA53504501
- FA53504506
- FA53504512
- FA53504518
- FA53504530
- FA53504533

3000K

- FA53500901
- FA53500906
- FA53500912
- FA53500918
- FA53500930
- FA53500933

4000K

- FA53500801
- FA53500806
- FA53500812
- FA53500818
- FA53500830
- FA53500833

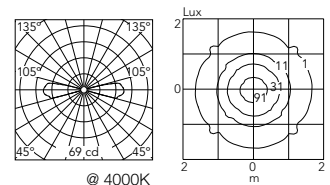

Gobi 130 Multi Low Voltage

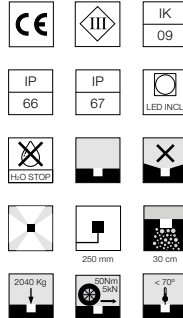
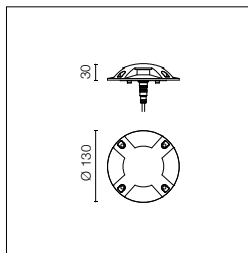

Sorgente a LED inclusa. Alimentazione elettrica remota 24Vdc da ordinare separatamente. Necessaria cassaforma da ordinare separatamente. Dotato di spezzone di cavo 250mm con connettore a vite M12 a tenuta stagna. Accessori opzionali: cavo 5000mm e cavo splitter 300mm con connettori M12 per installazioni multiple.

LED source included. 24V dc remote electric power supply to be ordered separately. Requires a junction box to be ordered separately. The luminaire is equipped with protruding, 250 mm cable with an M12 watertight screw-on connector. Optional accessories: 5000 mm cable and 300 mm splitter cable with M12 connectors for multiple installations.

2200K disponibile su richiesta.

2200K available on request.

Power Led: 5,8W - 4x129 lm ≠ OUTPUT 4x35 lm - 2700K/CRI 80 - 24Vdc / 5,8W - 4x139 lm ≠ OUTPUT 4x38 lm - 3000K/CRI 80 - 24Vdc / 5,8W - 4x148 lm ≠ OUTPUT 4x41 lm - 4000K/CRI 80 - 24Vdc

2700K

- FA53504601
- FA53504606
- FA53504612
- FA53504618
- FA53504630
- FA53504633

3000K

- FA53502701
- FA53502706
- FA53502712
- FA53502718
- FA53502730
- FA53502733

4000K

- FA53502601
- FA53502606
- FA53502612
- FA53502618
- FA53502630
- FA53502633

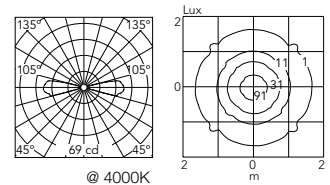







* Numero massimo di apparecchi per alimentatore / Maximum number of luminaires per power supply.

Numero massimo di apparecchi per alimentatore (Vin220÷240). Dati indicativi da verificare con le specifiche condizioni di installazione.

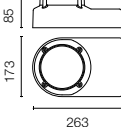
Maximum number of luminaires per power supply. (220÷240 V). These data must be checked taking into account the specific installation conditions.

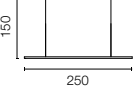
Acc. RF25752 1
Acc. F990B28A000 7
Acc. F990B27A000 12

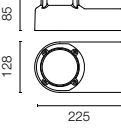
Gobi: Accessori / Accessories

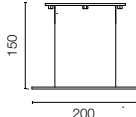
Scatola per incasso.	Box for installation.	Gobi 180 FA194		 85 173 263
Base di fissaggio a terra ad alta resistenza	High resistance in-ground box for installation	Gobi 180 FA195		 150 250
Scatola per incasso.	Box for installation.	Gobi 130 FA192		 85 128 225
Base di fissaggio a terra ad alta resistenza	High resistance in-ground box for installation	Gobi 130 FA193		 150 200

Gobi 130/180 220÷240V version - Wiring Installation

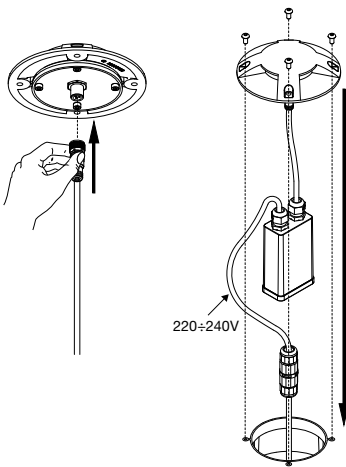

Example of installation

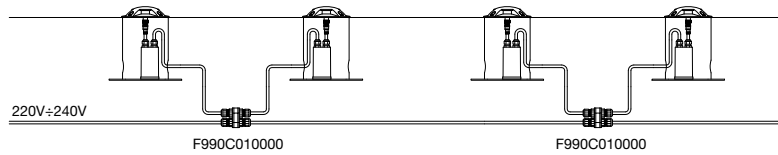

Gobi 130/180 24Vdc version - Wiring Installation

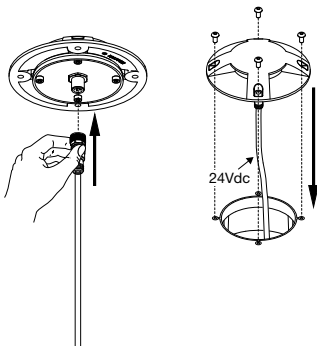



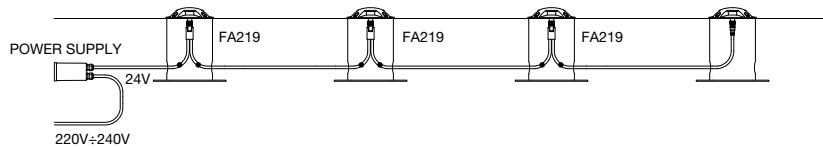

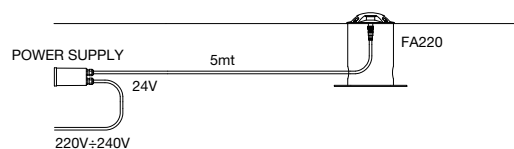

Example of installation 1



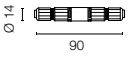

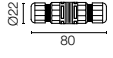

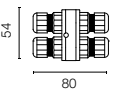

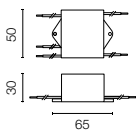

Example of installation 2

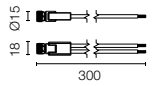

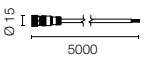
Gobi: Driver/ Drivers

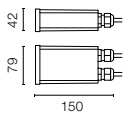
Sistema di giunzione IP68 a 2 vie 2 poli. (Ø4÷6,9mm cavo).	2 way terminal block 2 poles IP68. (Ø4÷6,9mm cable).	F990C050000		
Non può essere alloggiato nella scatola per incasso.	It can't be placed in the recessed box for installation.			
Sistema di giunzione IP68 H2O Stop anti-condensa a 2 vie 4 poli.	2 way terminal block 4 poles IP68 H2O Stop.	F990C00A000		
Sistema di giunzione IP68 H2O Stop anti-condensa a 3/4 vie 4 poli. (Ø5,5÷12mm cavo).	3/4 way terminal block 4 poles IP68 H2O Stop. (Ø5,5÷12mm cable).	F990C010000		
Dispositivo di protezione per il sovraccarico. 240 Vac. Corrente massima di scarica 10KA (8/29us). Massima corrente operativa 5A. Adatto per la connessione in serie. IP66.	Surge protection device. 275Vac. Maximum discharge current 10KA (8/20us). Maximum operating current 5A. Suitable for series connection. IP66.	F990E00A000		

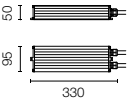
Gobi Low Voltage: Driver/ Drivers

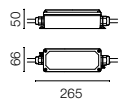
Connettore splitter m12.	Splitter m12 connector.	FA219		
Connettore singolo m12 L.5.000mm.	M12 single connector L.5.000mm.	FA220		
Alimentatore per installazione remota 24Vdc 20W / 220-240V IP67 Classe II selv.	Power supply for remote installation 24Vdc 20W / 220-240V IP67 Class II selv.	*RF25752		
Alimentatore per installazione remota 24Vdc 50W / 120-240V IP67 Classe II selv.	Power supply for remote installation 24Vdc 50W / 120-240V IP67 Class II selv.	*F990B28A000		
Alimentatore per installazione remota 24Vdc 70W / 220-240V IP67 Classe II selv.	Power supply for remote installation 24Vdc 70W / 220-240V IP67 Class II selv.	*F990B27A000		

Gobi 65 Mono

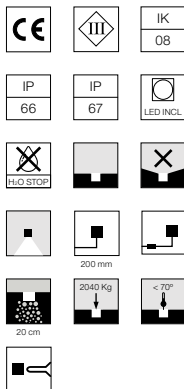
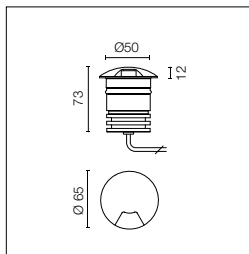

Sorgente a LED inclusa. Alimentazione elettrica remota 24V dc da ordinare separatamente. Necessaria cassaforma da ordinare separatamente. Dotato di spezzone di cavo uscente in neoprene 200 mm con sistema integrato di giunzione H2O STOP e kit con connettori crimp e guaina termorestringente adesiva per connessione a tenuta stagna. Versione dimmerabile a richiesta.

LED source included. 24V dc remote electric power supply to be ordered separately. Requires a junction box to be ordered separately. The luminaire is equipped with a protruding, 200 mm cable with an integrated H2O STOP connection system and a wiring kit with crimp connectors and adhesive heat-shrink tubing guaranteeing the water tightness of the connection. Adjustable light intensity version available upon request.

2200K disponibile su richiesta.

2200K available on request.

Power Led: 3,4W - 169 lm \neq OUTPUT 15 lm - 2700K/CRI 80 - 24Vdc / 3,4W - 182 lm \neq OUTPUT 16 lm - 3000K/CRI 80 - 24Vdc / 3,4W - 198 lm \neq OUTPUT 18 lm - 4000K/CRI 80 - 24Vdc

2700K

- FA51824201
- FA51824206
- FA51824212
- FA51824218
- FA51824230
- FA51824233
- FA51824256

3000K

- FA51804301
- FA51804306
- FA51804312
- FA51804318
- FA51804330
- FA51804333
- FA51804356

4000K

- FA51804201
- FA51804206
- FA51804212
- FA51804218
- FA51804230
- FA51804233
- FA51804256

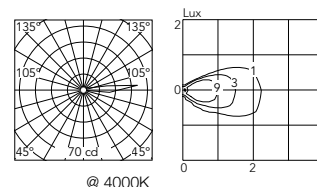

Gobi 65 Double

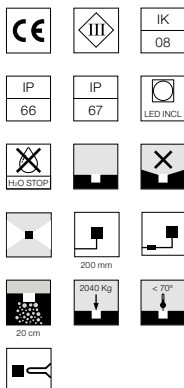
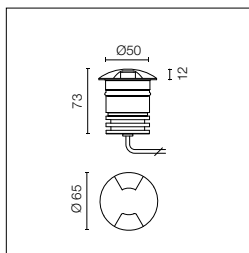

Sorgente a LED inclusa. Alimentazione elettrica remota 24V dc da ordinare separatamente. Necessaria cassaforma da ordinare separatamente. Dotato di spezzone di cavo uscente in neoprene 200 mm con sistema integrato di giunzione H2O STOP e kit con connettori crimp e guaina termorestringente adesiva per connessione a tenuta stagna. Versione dimmerabile a richiesta.

LED source included. 24V dc remote electric power supply to be ordered separately. Requires a junction box to be ordered separately. The luminaire is equipped with a protruding, 200 mm cable with an integrated H2O STOP connection system and a wiring kit with crimp connectors and adhesive heat-shrink tubing guaranteeing the water tightness of the connection. Adjustable light intensity version available upon request.

2200K disponibile su richiesta.

2200K available on request.

Power Led: 3,4W - 2x169 lm \neq OUTPUT 2x15 lm - 2700K/CRI 80 - 24Vdc / 3,4W - 2x182 lm \neq OUTPUT 2x16 lm - 3000K/CRI 80 - 24Vdc / 3,4W - 2x198 lm \neq OUTPUT 2x18 lm - 4000K/CRI 80 - 24Vdc

2700K

- FA51825201
- FA51825206
- FA51825212
- FA51825218
- FA51825230
- FA51825233
- FA51825256

3000K

- FA51805301
- FA51805306
- FA51805312
- FA51805318
- FA51805330
- FA51805333
- FA51805356

4000K

- FA51805201
- FA51805206
- FA51805212
- FA51805218
- FA51805230
- FA51805233
- FA51805256

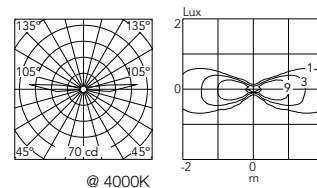

Gobi 65 Triple

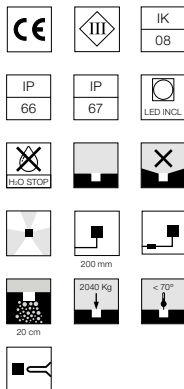
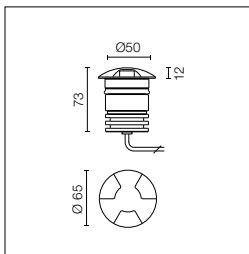

Sorgente a LED inclusa. Alimentazione elettrica remota 24V dc da ordinare separatamente. Necessaria cassaforma da ordinare separatamente. Dotato di spezzone di cavo uscente in neoprene 200 mm con sistema integrato di giunzione H2O STOP e kit con connettori crimp e guaina termorestringente adesiva per connessione a tenuta stagna. Versione dimmerabile a richiesta.

LED source included. 24V dc remote electric power supply to be ordered separately. Requires a junction box to be ordered separately. The luminaire is equipped with a protruding, 200 mm cable with an integrated H2O STOP connection system and a wiring kit with crimp connectors and adhesive heat-shrink tubing guaranteeing the water tightness of the connection. Adjustable light intensity version available upon request.

2200K disponibile su richiesta.

2200K available on request.

Power Led: 3,4W - 3x169 lm \neq OUTPUT 3x15 lm - 2700K/CRI 80 - 24Vdc / 3,4W - 3x182 lm \neq OUTPUT 3x16 lm - 3000K/CRI 80 - 24Vdc / 3,4W - 3x198 lm \neq OUTPUT 3x18 lm - 4000K/CRI 80 - 24Vdc

2700K

- FA51826201
- FA51826206
- FA51826212
- FA51826218
- FA51826230
- FA51826233
- FA51826256

3000K

- FA51806301
- FA51806306
- FA51806312
- FA51806318
- FA51806330
- FA51806333
- FA51806356

4000K

- FA51806201
- FA51806206
- FA51806212
- FA51806218
- FA51806230
- FA51806233
- FA51806256

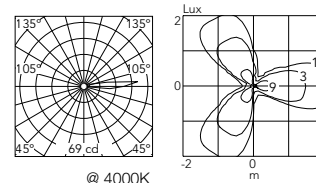

Gobi 65 Multi

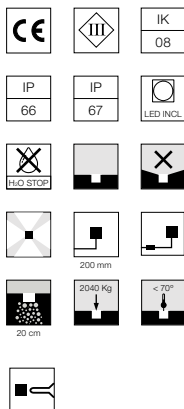
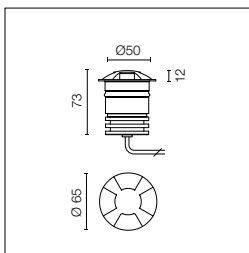

Sorgente a LED inclusa. Alimentazione elettrica remota 24V dc da ordinare separatamente. Necessaria cassaforma da ordinare separatamente. Dotato di spezzone di cavo uscente in neoprene 200 mm con sistema integrato di giunzione H2O STOP e kit con connettori crimp e guaina termorestringente adesiva per connessione a tenuta stagna. Versione dimmerabile a richiesta.

LED source included. 24V dc remote electric power supply to be ordered separately. Requires a junction box to be ordered separately. The luminaire is equipped with a protruding, 200 mm cable with an integrated H2O STOP connection system and a wiring kit with crimp connectors and adhesive heat-shrink tubing guaranteeing the water tightness of the connection. Adjustable light intensity version available upon request.

2200K disponibile su richiesta.

2200K available on request.

Power Led: 3,4W - 4x169 lm \neq OUTPUT 4x15 lm - 2700K/CRI 80 - 24Vdc / 3,4W - 4x182 lm \neq OUTPUT 4x16 lm - 3000K/CRI 80 - 24Vdc / 3,4W - 4x198 lm \neq OUTPUT 4x18 lm - 4000K/CRI 80 - 24Vdc

2700K

- FA51827201
- FA51827206
- FA51827212
- FA51827218
- FA51827230
- FA51827233
- FA51827256

3000K

- FA51807301
- FA51807306
- FA51807312
- FA51807318
- FA51807330
- FA51807333
- FA51807356

4000K

- FA51807201
- FA51807206
- FA51807212
- FA51807218
- FA51807230
- FA51807233
- FA51807256

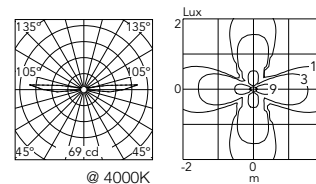

Gobi 65 Wall Path

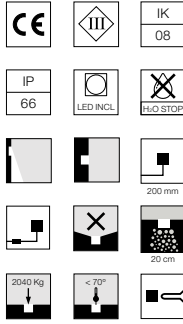
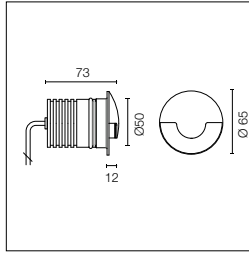

Sorgente a LED inclusa. Alimentazione elettrica remota 24V dc da ordinare separatamente. Necessaria cassaforma da ordinare separatamente. Dotato di spezzone di cavo uscente in neoprene 200 mm e kit con connettori crimp e guaina termorestringente adesiva per connessione a tenuta stagna. Versione dimmerabile a richiesta.

LED source included. 24V dc remote electric power supply to be ordered separately. Requires a junction box to be ordered separately. The luminaire is equipped with a protruding, 200 mm cable and a wiring kit with crimp connectors and adhesive heat-shrink tubing guaranteeing the water tightness of the connection. Adjustable light intensity version available upon request.

2200K disponibile su richiesta.

2200K available on request.

Power Led: 3,4W - 169 lm ≠ OUTPUT 47 lm - 2700K/CRI 80 - 24Vdc / 3,4W - 182 lm ≠ OUTPUT 50 lm - 3000K/CRI 80 - 24Vdc / 3,4W - 198 lm ≠ OUTPUT 54 lm - 4000K/CRI 80 - 24Vdc

2700K

- FA51828201
- FA51828206
- FA51828212
- FA51828218
- FA51828230
- FA51828233
- FA51828256

3000K

- FA51808301
- FA51808306
- FA51808312
- FA51808318
- FA51808330
- FA51808333
- FA51808356

4000K



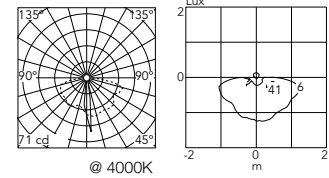

- FA51808201
- FA51808206
- FA51808212
- FA51808218
- FA51808230
- FA51808233
- FA51808256

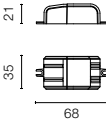

Gobi 65: Accessori / Accessories

Scatola per incasso	Box for installation	F004Z0K0000		
Sistema di giunzione IP68 a 2 vie 2 poli. (Ø4÷6,9mm cavo).	2 way terminal block 2 poles IP68. (Ø4÷6,9mm cable).	F990C050000		
Non può essere alloggiato nella scatola per incasso.	It can't be placed in the recessed box for installation.			

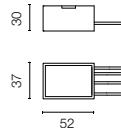
Gobi 65: Driver/ Drivers

Alimentatore doppia funzione Vout 24Vdc: 8W/100÷240V Iout 350ma: 6x1W/100÷240V IP20 Classe II Selv Eq.	Power supply dual function Vout 24Vdc: 8W/100÷240V Iout 350ma: 6x1W/100÷240V IP20 Class II Selv Eq.	*RF25754		
Alimentatore 24V 8W / 110-240V IP65 Classe II selv.	Power supply 24V 8W / 110-240V IP65 Class II selv.	*RF25748		
Alimentatore 24V 10W / 110-240V IP20 Classe II selv.	Power supply 24V 10W / 110-240V IP20 Class II selv.	*RF25747		
Alimentatore 24V 10W / 110-240V IP67 Classe II selv.	Power supply 24V 10W / 110-240V IP67 Class II selv.	*RF25757		
Alimentatore per installazione remota 24Vdc 20W / 220-240V IP67 Classe II selv.	Power supply for remote installation 24Vdc 20W / 220-240V IP67 Class II selv.	*RF25752		
Alimentatore per installazione remota 24Vdc 50W / 120-240V IP67 Classe II selv.	Power supply for remote installation 24Vdc 50W / 120-240V IP67 Class II selv.	*F990B28A000		
Alimentatore per installazione remota 24Vdc 70W / 220-240V IP67 Classe II selv.	Power supply for remote installation 24Vdc 70W / 220-240V IP67 Class II selv.	*F990B27A000		

* Numero massimo di apparecchi per alimentatore / Maximum number of luminaires per power supply.

Numero massimo di apparecchi per alimentatore (Vin220÷240). Dati indicativi da verificare con le specifiche condizioni di installazione.

Maximum number of luminaires per power supply. (220÷240 V). These data must be checked taking into account the specific installation conditions.

Acc. RF25754	1
Acc. RF25748	1
Acc. RF25747	2
Acc. RF25757	2

Acc. RF25752	3
Acc. F990B28A000	9
Acc. F990B27A000	17

Gobi 49 Mono

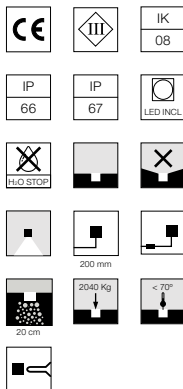
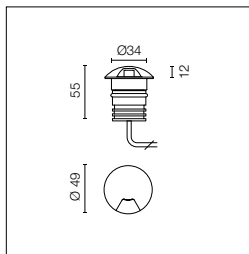

Sorgente a LED inclusa. Alimentazione elettrica remota 24V dc da ordinare separatamente. Necessaria cassaforma da ordinare separatamente. Dotato di spezzone di cavo uscente in neoprene 200 mm con sistema integrato di giunzione H2O STOP e kit con connettori crimp e guaina termorestringente adesiva per connessione a tenuta stagna. Versione dimmerabile a richiesta.

LED source included. 24V dc remote electric power supply to be ordered separately. Requires a junction box to be ordered separately. The luminaire is equipped with a protruding, 200 mm cable with an integrated H2O STOP connection system and a wiring kit with crimp connectors and adhesive heat-shrink tubing guaranteeing the water tightness of the connection. Adjustable light intensity version available upon request.

2200K disponibile su richiesta.

2200K available on request.

Power Led: 2,3W - 139 lm \neq OUTPUT 10 lm - 2700K/CRI 80 -24Vdc / 2,3W - 149 lm \neq OUTPUT 11 lm - 3000K/CRI 80 -24Vdc / 2,3W - 162 lm \neq OUTPUT 12 lm - 4000K/CRI 80 -24Vdc

2700K

- FA51702501
- FA51702506
- FA51702512
- FA51702518
- FA51702530
- FA51702533
- FA51702556

3000K

- FA51702301
- FA51702306
- FA51702312
- FA51702318
- FA51702330
- FA51702333
- FA51702356

4000K

- FA51702201
- FA51702206
- FA51702212
- FA51702218
- FA51702230
- FA51702233
- FA51702256

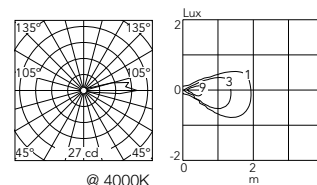

Gobi 49 Double

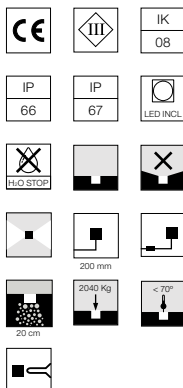
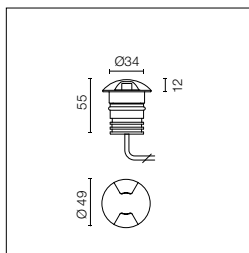

Sorgente a LED inclusa. Alimentazione elettrica remota 24V dc da ordinare separatamente. Necessaria cassaforma da ordinare separatamente. Dotato di spezzone di cavo uscente in neoprene 200 mm con sistema integrato di giunzione H2O STOP e kit con connettori crimp e guaina termorestringente adesiva per connessione a tenuta stagna. Versione dimmerabile a richiesta.

LED source included. 24V dc remote electric power supply to be ordered separately. Requires a junction box to be ordered separately. The luminaire is equipped with a protruding, 200 mm cable with an integrated H2O STOP connection system and a wiring kit with crimp connectors and adhesive heat-shrink tubing guaranteeing the water tightness of the connection. Adjustable light intensity version available upon request.

2200K disponibile su richiesta.

2200K available on request.

Power Led: 2,3W - 2x139 lm \neq OUTPUT 2x10 lm - 2700K/CRI 80 -24Vdc / 2,3W - 2x149 lm \neq OUTPUT 2x11 lm - 3000K/CRI 80 -24Vdc / 2,3W - 2x162 lm \neq OUTPUT 2x12 lm - 4000K/CRI 80 -24Vdc

2700K

- FA51703501
- FA51703506
- FA51703512
- FA51703518
- FA51703530
- FA51703533
- FA51703556

3000K

- FA51703301
- FA51703306
- FA51703312
- FA51703318
- FA51703330
- FA51703333
- FA51703356

4000K

- FA51703201
- FA51703206
- FA51703212
- FA51703218
- FA51703230
- FA51703233
- FA51703256

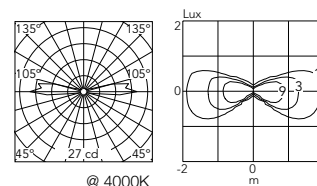

Gobi 49 Triple

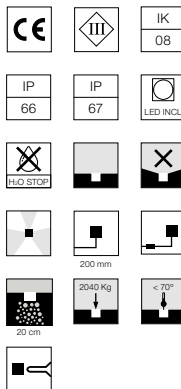
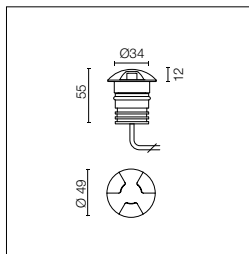

Sorgente a LED inclusa. Alimentazione elettrica remota 24V dc da ordinare separatamente. Necessaria cassaforma da ordinare separatamente. Dotato di spezzone di cavo uscente in neoprene 200 mm con sistema integrato di giunzione H2O STOP e kit con connettori crimp e guaina termorestringente adesiva per connessione a tenuta stagna. Versione dimmerabile a richiesta.

LED source included. 24V dc remote electric power supply to be ordered separately. Requires a junction box to be ordered separately. The luminaire is equipped with a protruding, 200 mm cable with an integrated H2O STOP connection system and a wiring kit with crimp connectors and adhesive heat-shrink tubing guaranteeing the water tightness of the connection. Adjustable light intensity version available upon request.

2200K disponibile su richiesta.

2200K available on request.

Power Led: 2,3W - 3x139 lm ≠ OUTPUT 3x10 lm - 2700K/CRI 80 -24Vdc / 2,3W - 3x149 lm ≠ OUTPUT 3x11 lm - 3000K/CRI 80 -24Vdc / 2,3W - 3x162 lm ≠ OUTPUT 3x12 lm - 4000K/CRI 80 -24Vdc

2700K

- FA51704501
- FA51704506
- FA51704512
- FA51704518
- FA51704530
- FA51704533
- FA51704556

3000K

- FA51704301
- FA51704306
- FA51704312
- FA51704318
- FA51704330
- FA51704333
- FA51704356

4000K

- FA51704201
- FA51704206
- FA51704212
- FA51704218
- FA51704230
- FA51704233
- FA51704256

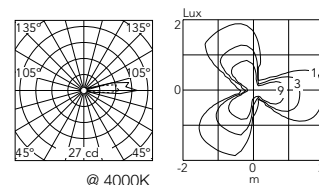

Gobi 49 Multi

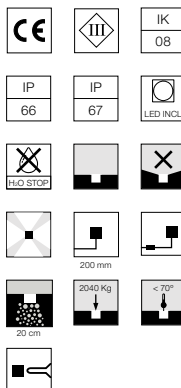
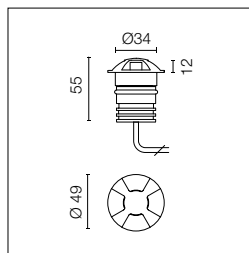

Sorgente a LED inclusa. Alimentazione elettrica remota 24V dc da ordinare separatamente. Necessaria cassaforma da ordinare separatamente. Dotato di spezzone di cavo uscente in neoprene 200 mm con sistema integrato di giunzione H2O STOP e kit con connettori crimp e guaina termorestringente adesiva per connessione a tenuta stagna. Versione dimmerabile a richiesta.

LED source included. 24V dc remote electric power supply to be ordered separately. Requires a junction box to be ordered separately. The luminaire is equipped with a protruding, 200 mm cable with an integrated H2O STOP connection system and a wiring kit with crimp connectors and adhesive heat-shrink tubing guaranteeing the water tightness of the connection. Adjustable light intensity version available upon request.

2200K disponibile su richiesta.

2200K available on request.

Power Led: 2,3W - 4x139 lm ≠ OUTPUT 4x10 lm - 2700K/CRI 80 -24Vdc / 2,3W - 4x149 lm ≠ OUTPUT 4x11 lm - 3000K/CRI 80 -24Vdc / 2,3W - 4x162 lm ≠ OUTPUT 4x12 lm - 4000K/CRI 80 -24Vdc

2700K

- FA51705501
- FA51705506
- FA51705512
- FA51705518
- FA51705530
- FA51705533
- FA51705556

3000K

- FA51705301
- FA51705306
- FA51705312
- FA51705318
- FA51705330
- FA51705333
- FA51705356

4000K

- FA51705201
- FA51705206
- FA51705212
- FA51705218
- FA51705230
- FA51705233
- FA51705256

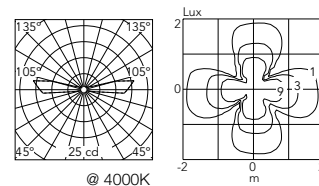

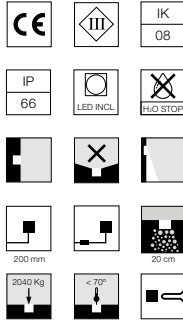
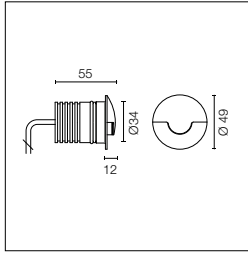

Sorgente a LED inclusa.
Alimentazione elettrica remota 24V dc da ordinare separatamente. Necessaria cassaforma da ordinare separatamente. Dotato di spezzone di cavo uscente in neoprene 200 mm e kit con connettori crimp e guaina termorestringente adesiva per connessione a tenuta stagna. Versione dimmerabile a richiesta.

LED source included. 24V dc remote electric power supply to be ordered separately. Requires a junction box to be ordered separately. The luminaire is equipped with a protruding, 200 mm cable and a wiring kit with crimp connectors and adhesive heat-shrink tubing guaranteeing the water tightness of the connection. Adjustable light intensity version available upon request.

2200K disponibile su richiesta.

2200K available on request.

Power Led: 2,3W - 139 lm \neq OUTPUT 36 lm - 2700K/CRI 80 -24Vdc / 2,3W - 149 lm \neq OUTPUT 39 lm - 3000K/CRI 80 -24Vdc / 2,3W - 162 lm \neq OUTPUT 42 lm - 4000K/CRI 80 -24Vdc

2700K

- FA51706501
- FA51706506
- FA51706512
- FA51706518
- FA51706530
- FA51706533
- FA51706556

3000K

- FA51706301
- FA51706306
- FA51706312
- FA51706318
- FA51706330
- FA51706333
- FA51706356

4000K



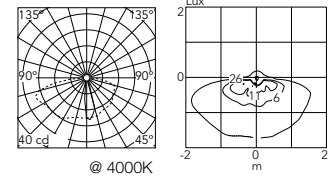



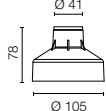
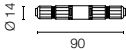



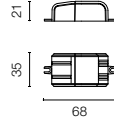

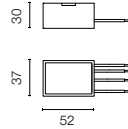
- FA51706201
- FA51706206
- FA51706212
- FA51706218
- FA51706230
- FA51706233
- FA51706256

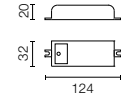

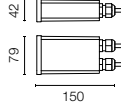
Gobi 49: Accessori / Accessories

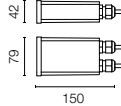
Scatola per incasso	Box for installation	F004Z0J0000		
Sistema di giunzione IP68 a 2 vie 2 poli. (Ø4÷6,9mm cavo).	2 way terminal block 2 poles IP68. (Ø4÷6,9mm cable).	F990C050000		
Non può essere alloggiato nella scatola per incasso.	It can't be placed in the recessed box for installation.			

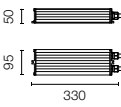
Gobi 49: Driver/ Drivers

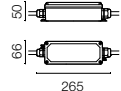
Alimentatore doppia funzione Vout 24Vdc: 8W/100÷240V Iout 350ma: 6x1W/100÷240V IP20 Classe II Selv Eq.	Power supply dual function Vout 24Vdc: 8W/100÷240V Iout 350ma: 6x1W/100÷240V IP20 Class II Selv Eq.	*RF25754		
Alimentatore 24V 8W / 110-240V IP65 Classe II selv.	Power supply 24V 8W / 110-240V IP65 Class II selv.	*RF25748		
Alimentatore 24V 10W / 110-240V IP20 Classe II selv.	Power supply 24V 10W / 110-240V IP20 Class II selv.	*RF25747		
Alimentatore 24V 10W / 110-240V IP67 Classe II selv.	Power supply 24V 10W / 110-240V IP67 Class II selv.	*RF25757		
Alimentatore per installazione remota 24Vdc 20W / 220-240V IP67 Classe II selv.	Power supply for remote installation 24Vdc 20W / 220-240V IP67 Class II selv.	*RF25752		
Alimentatore per installazione remota 24Vdc 50W / 120-240V IP67 Classe II selv.	Power supply for remote installation 24Vdc 50W / 120-240V IP67 Class II selv.	*F990B28A000		
Alimentatore per installazione remota 24Vdc 70W / 220-240V IP67 Classe II selv.	Power supply for remote installation 24Vdc 70W / 220-240V IP67 Class II selv.	*F990B27A000		

* Numero massimo di apparecchi per alimentatore / Maximum number of luminaires per power supply.

Numero massimo di apparecchi per alimentatore (Vin220÷240). Dati indicativi da verificare con le specifiche condizioni di installazione.

Maximum number of luminaires per power supply. (220÷240 V). These data must be checked taking into account the specific installation conditions.

Acc. RF25754 1
Acc. RF25748 1
Acc. RF25747 4
Acc. RF25757 4

Acc. RF25752 5
Acc. F990B28A000 14
Acc. F990B27A000 29

