

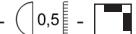







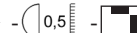

Lotus E27/G23

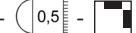
last update 14/10/2015

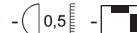
BEL1045

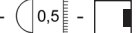
Lotus A :	code 120.G23. __	9W TC-S/G23 - 230V - CE - IP54 -  - 
	code 120.E27. __	max.18W TC-TSE/E27 or max.75W A60/E27 - 230V - CE - IP54 -  - 
Lotus B :	code 122.G23. __	9W TC-S/G23 - 230V - CE - IP54 -  - 
	code 122.E27. __	max.18W TC-TSE/E27 or max.75W A60/E27 - 230V - CE - IP54 -  - 
Lotus C :	code 125.G23. __	9W TC-S/G23 - 230V - CE - IP54 -  - 
	code 125.E27. __	max.18W TC-TSE/E27 or max.75W A60/E27 - 230V - CE - IP54 -  - 

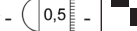
BEL LIGHTING

BEL LIGHTING sprl
Avenue Ernest Solvay 42
B-1480 Saintes (Tubize)
Belgium
Phone: +32(0)2 3552428
Fax: +32(0)2 3550396
e-mail: info@bel-lighting.com
www.bel-lighting.com

INSTALLATION INSTRUCTIONS - PART A

1. FIT THE WALL FIXATION ON THE WALL
2. MAKE THE ELECTRICAL CONNECTION
3. PLACE THE LUMINARY
4. SWITCH ON

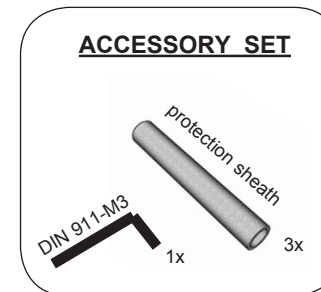
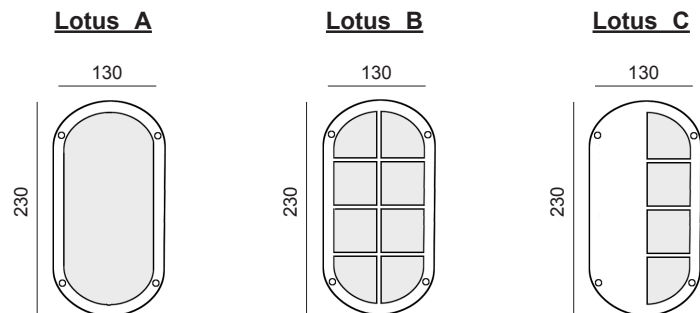

PART

A

Lees de algemene gebruiksvoorwaarden : PART B
Lire attentivement les conditions generales d'utilisation : PART B
Read attentively the general instructions: PART B
Lesen Sie die allgemeinen Gebrauchsanweisungen: PART B
Διαβάστε τις γενικές οδηγίες : PART B

1 Wall Fixation - Dimension Holes

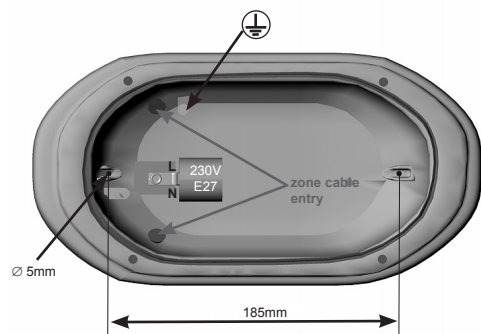

IMPORTANT : Gland for cable $\varnothing 8$ ---> 10mm

2 ELECTRICAL CONNECTION

NL - Voeg de voedingskabel in de beschermingskoker
FR - Insérer le câble d'alimentation dans la gaine de protection.
EN - Insert the feeder in the protection sheath
DE - Das Kabel in die Schutzhülle einfügen
ΕΛ - Παρεμβάλετε τον τροφοδοτή στη θηκη προστασίας

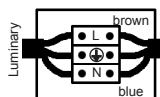
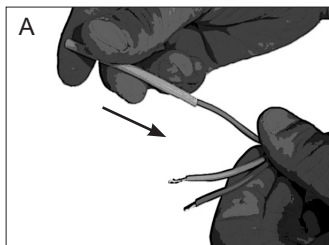

3 NL - Maak de schroeven steeds allemaal geleidelijk los of vast: schroef dus nooit 1 vijs helemaal los of vast, maar schroef alle schroeven diagonaal beetje bij beetje los of vast.
FR - Bloquer et débloquer les vis de fermeture "en croix", par séquence alternée, comme sur la figure.
EN - Lock and unlock the screws following an alternate sequence.
DE - Die Verschlusschrauben kreuzweise anziehen bzw. lösen.
ΕΛ - Κλειδώστε και ξεκλειδώστε τις βίδες ακολουθώντας έναν εναλλακτικό τρόπο.

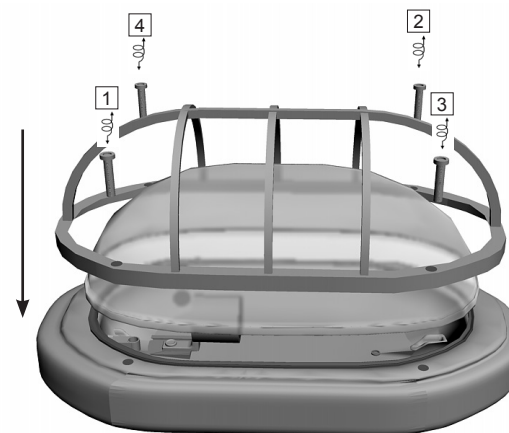













WAARSCHUWING
AVERTISSEMENT
WARNING
ΠΡΟΣΟΧΗ

Lotus E27/G23

last update 14/10/2015

BEL1045

Lotus D :	code 134.G23. __	2x9W TC-S/G23 - 230V - CE - IP54 -  -  - 
	code 134.E27. __	max.18W TC-TSE/E27 or max.100W A60/E27 - 230V - CE - IP54 -  -  - 
Lotus E :	code 138.G23. __	2x9W TC-S/G23 - 230V - CE - IP54 -  -  - 
	code 138.E27. __	max.18W TC-TSE/E27 or max.100W A60/E27 - 230V - CE - IP54 -  -  - 

BEL LIGHTING

BEL LIGHTING sprl
Avenue Ernest Solvay 42
B-1480 Saintes (Tubize)
Belgium
Phone: +32(0)2 3552428
Fax: +32(0)2 3550396
e-mail: info@bel-lighting.com
www.bel-lighting.com

INSTALLATION INSTRUCTIONS - PART A

1. FIT THE WALL FIXATION ON THE WALL
2. MAKE THE ELECTRICAL CONNECTION
3. PLACE THE LUMINARY
4. SWITCH ON

Lotus D

∅ 260

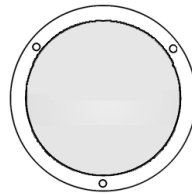

Lotus E

∅ 260

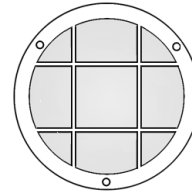

ACCESSORY SET

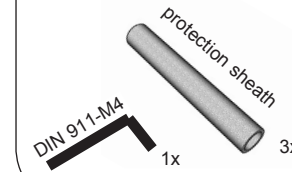

PART

A

Lees de algemene gebruiksvoorwaarden : PART B
Lire attentivement les conditions generales d'utilisation: PART B
Read attentively the general instructions: PART B
Lesen Sie die allgemeinen Gebrauchsanweisungen: PART B
Διαβάστε της γενικές οδηγίες : PART B

1 Wall Fixation - Dimension Holes

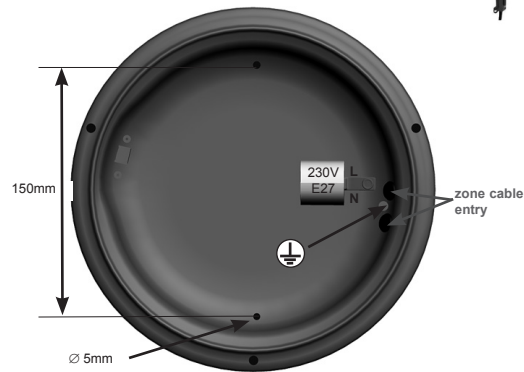

IMPORTANT : Gland for cable ∅ 8 → 10mm

2 ELECTRICAL CONNECTION

NL - Voeg de voedingskabel in de beschermingskoker
FR - Insérer le câble d'alimentation dans la gaine de protection.
EN - Insert the feeder in the protection sheath
DE - Das Kabel in die Schutzhülle einfügen
EL - Παρεμβάλετε τον τροφοδοτή στη θήκη προστασίας

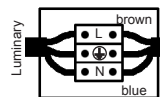
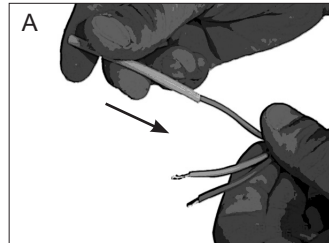

3 NL - Maak de schroeven steeds allemaal geleidelijk los of vast: schroef dus nooit 1 vjs helemaal los of vast, maar schroef alle schroeven diagonaal beetje bij beetje los of vast.
FR - Bloquer et débloquer les vis de fermeture "en croix", par séquence alternée, comme sur la figure.
EN - Lock and unlock the screws following an alternante sequence.
DE - Die Verschlusschrauben kreuzweise anziehen bzw. lösen.
EL - Κλειδώστε και ξεκλειδώστε τις βίδες ακολουθώντας έναν εναλλακτικό τρόπο.

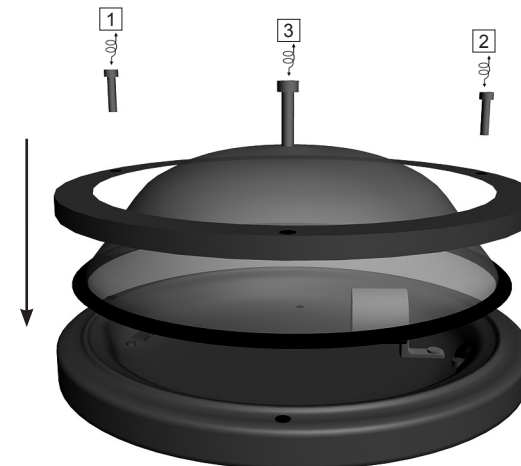

Lotus W40/W80

last update 14/10/2015

BEL1045

Lotus A :	code 120.W40. __	6W - 230V - CE - IP54			
	code 120.W80. __	9W - 230V - CE - IP54			
Lotus B :	code 122.W40. __	6W - 230V - CE - IP54			
	code 122.W80. __	9W - 230V - CE - IP54			
Lotus C :	code 125.W40. __	6W - 230V - CE - IP54			
	code 125.W80. __	9W - 230V - CE - IP54			

BEL LIGHTING

BEL LIGHTING sprl
Avenue Ernest Solvay 42
B-1480 Saintes (Tubize)
Belgium
Phone: +32(0)2 3552428
Fax: +32(0)2 3550396
e-mail: info@bel-lighting.com
www.bel-lighting.com

with LED 9W

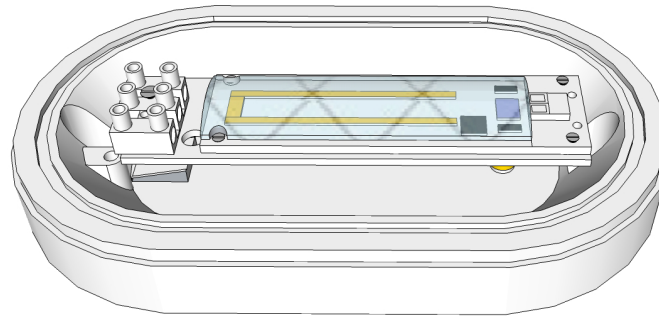

with LED 6W

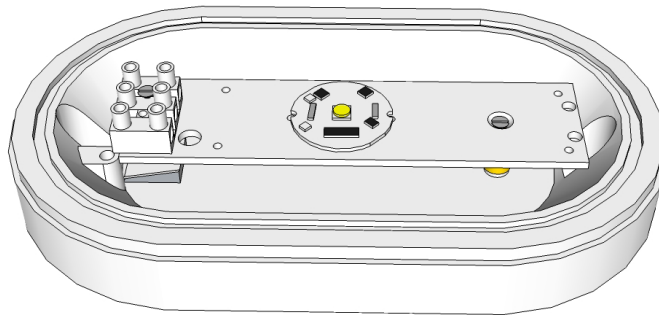

PART

A

Lees de algemene gebruiksvoorwaarden : PART B
Lire attentivement les conditions generales d'utilisation: PART B
Read attentively the general instructions: PART B
Lesen Sie die allgemeinen Gebrauchsanweisungen: PART B
Διαβάστε τις γενικές οδηγίες : PART B

WAARSCHUWING
AVERTISSEMENT
WARNING
WARNUNG
ΠΡΟΣΟΧΗ

Lotus W40/W80

last update 14/10/2015

BEL1045

Lotus D :	code 134.W40._ _	6W - 230V - CE - IP54 -  -  - 
	code 134.W80._ _	14W - 230V - CE - IP54 -  -  - 
Lotus E :	code 138.W40._ _	6W - 230V - CE - IP54 -  -  - 
	code 138.W80._ _	14W - 230V - CE - IP54 -  -  - 



BEL LIGHTING

BEL LIGHTING sprl
Avenue Ernest Solvay 42
B-1480 Saintes (Tubize)
Belgium
Phone: +32(0)2 3552428
Fax: +32(0)2 3550396
e-mail: info@bel-lighting.com
www.bel-lighting.com

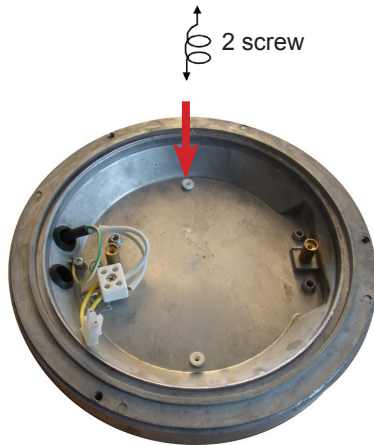
1. Fixing the luminaire connection cabling 220-240V

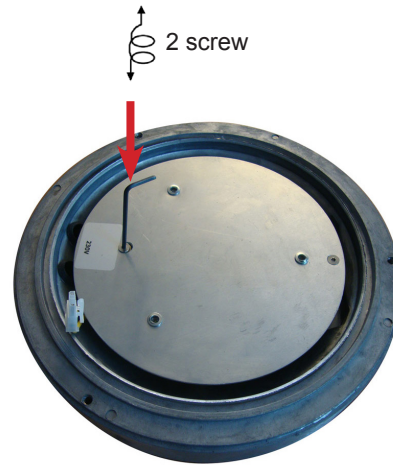

2. Fixing of the LED substrate



3. Fixing and connecting of LED

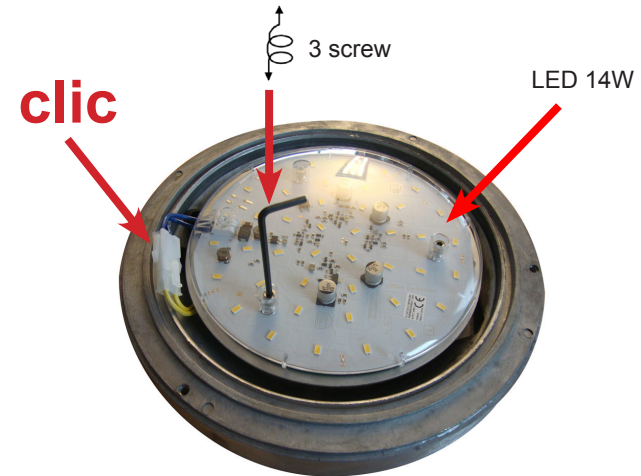

4. Closing the luminaire

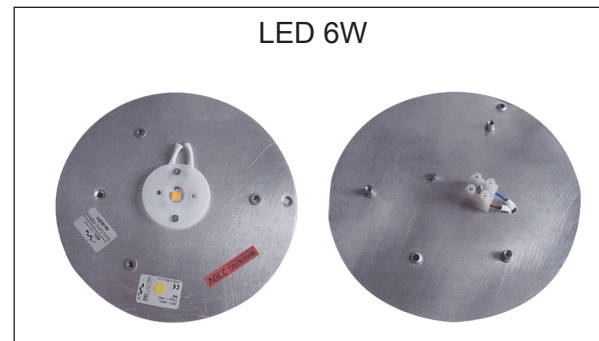

PART

A

Lees de algemene gebruiksvoorwaarden : PART B
Lire attentivement les conditions generales d'utilisation: PART B
Read attentively the general instructions: PART B
Lesen Sie die allgemeinen Gebrauchsanweisungen: PART B
Διαβάστε της γενικές οδηγίες : PART B

WAARSCHUWING
AVERTISSEMENT
WARNING
WARNUNG
ΠΡΟΣΟΧΗ