

DEEPER IP44

INSTALLATION INSTRUCTIONS | JULY 2024

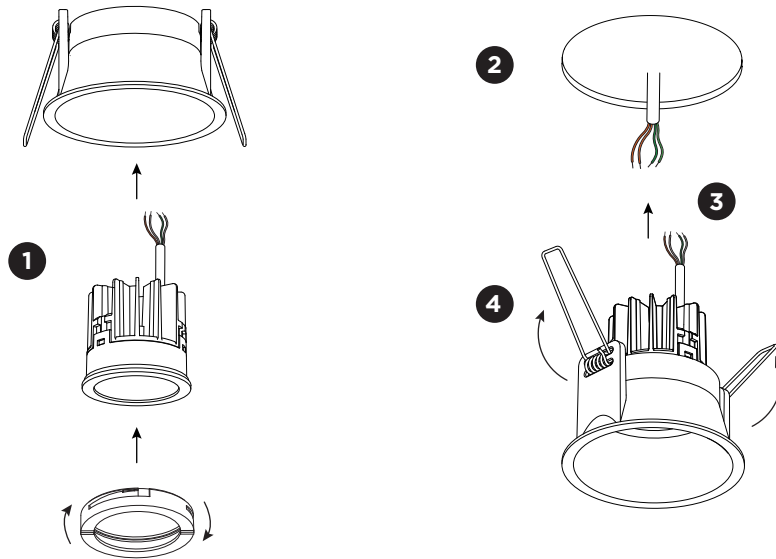

DIMENSIONS

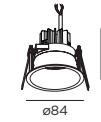

1.0 LOXONE

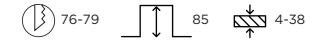

MOUNTING INSTRUCTION

- 1 Put the light source in the assembly set by locking the lamp ring in the housing by turning it a quarter clockwise.
- 2 Make a hole in the ceiling according to the prescribed dimensions.
- 3 **POWER CONNECTION**
Connect the wires to the connectors.
Input voltage 20-28V.



- 4 For wire springs:
Push the springs upwards and insert the fixture in the ceiling hole.

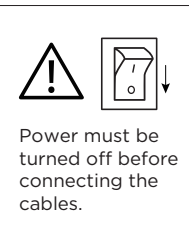

Power must be turned off before connecting the cables.

This fixture only works with Loxone TREE.

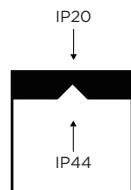

↑ IP44 RATING
Fixture is IP20 on the recessed part and IP44 on the visible/outer side

DEEPER

INSTALLATION INSTRUCTIONS | JULY 2024

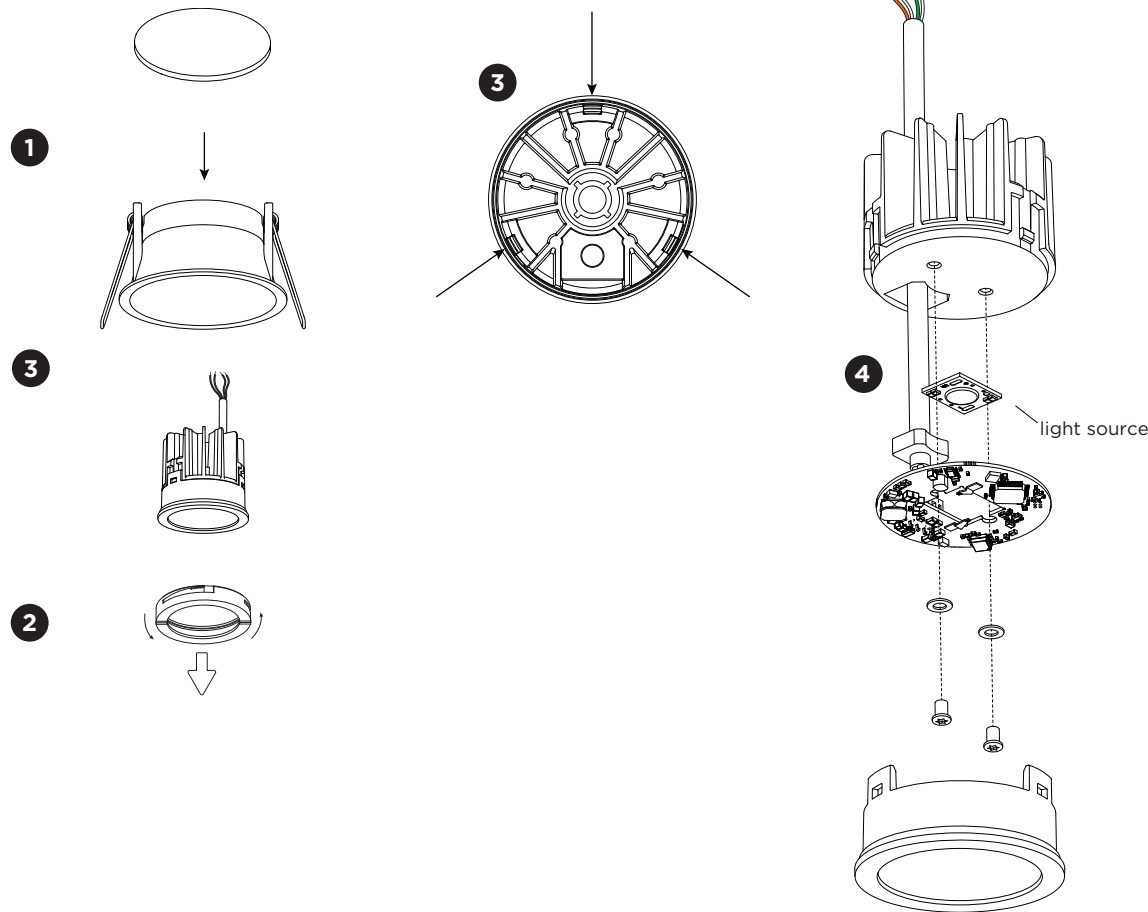

DISMOUNTING AND RECYCLING INSTRUCTIONS

Light source

- 1 Remove the fixture from the ceiling and disconnect the wires.
- 2 Hold and turn the front ring a quarter counterclockwise to remove the LED module.
- 3 Push at the three points to loosen the cover with lens.
- 4 Unscrew the light source to remove it.

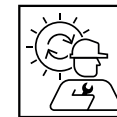

The light source is replaceable by Wever & Ducré or by a professional with explicit authorisation. For more information please contact your local Wever & Ducré customer service point.



This luminaire contains a light source with the energy class F.



WEVER & DUCRÉ
LIGHTING

WEVER & DUCRÉ BV

Spinnerijstraat 99/21, 8500 Kortrijk, Belgium
weverducre.com