

ILANE 1.0

INSTALLATION INSTRUCTIONS | DECEMBER 2021

COMPONENTS

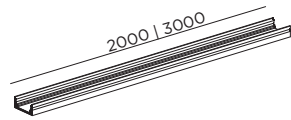

ALUMINUM PROFILE

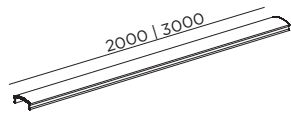

DIFFUSER

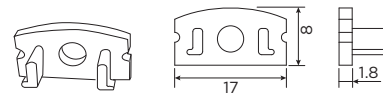

A | END CAP

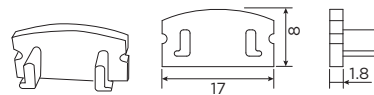
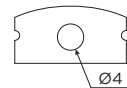

B | END CAP

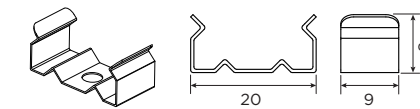
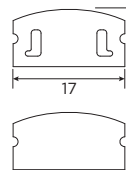

MOUNTING CLIP

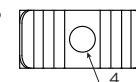

DIMENSIONS

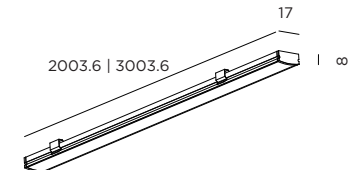
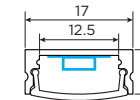

model	content				
	profile	diffuser	closed end cap	end cap with hole	mounting clips
2000 mm	1	1	2	1	5
3000 mm	1	1	2	1	7

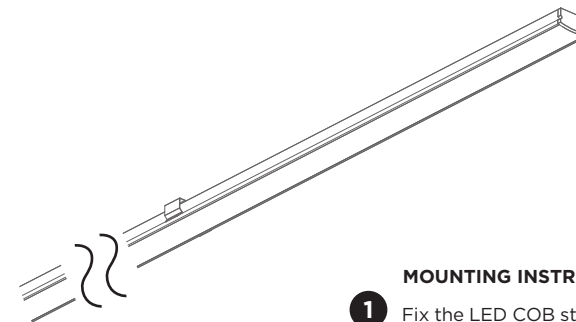
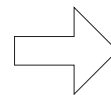
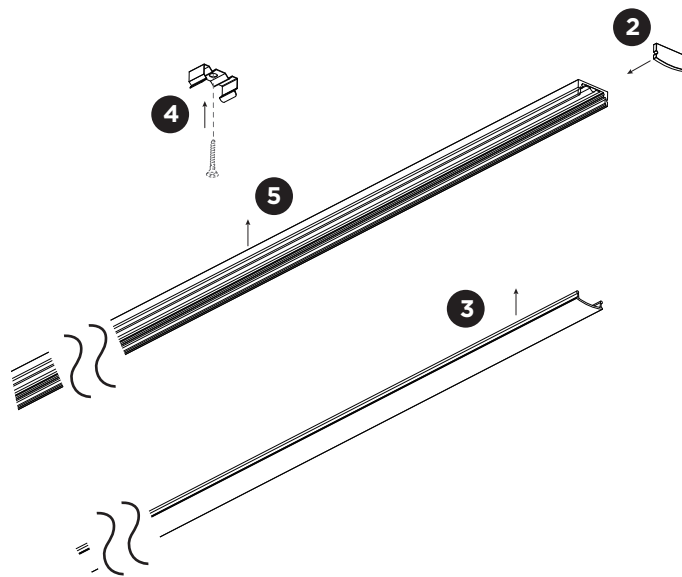

MOUNTING INSTRUCTION

- 1 Fix the LED COB strip into the profile (see page 2).
- 2 Mount the end caps on the ends of the profile.
- 3 Insert the diffuser into the profile.
- 4 Fix the mounting clips to the ceiling with screws (screws are not included). Alternatively fix the profile to the surface by means of double sided tape or glue.
- 5 Push the assembled profile into the mounting clips.



WEVER & DUCRÉ
LIGHTING

WEVER & DUCRÉ BV
Spinnerijstraat 99/21, 8500 Kortrijk, Belgium
weverducre.com

ILANE 1.0

INSTALLATION INSTRUCTIONS | DECEMBER 2021

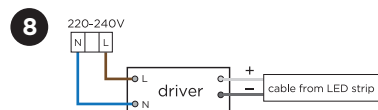
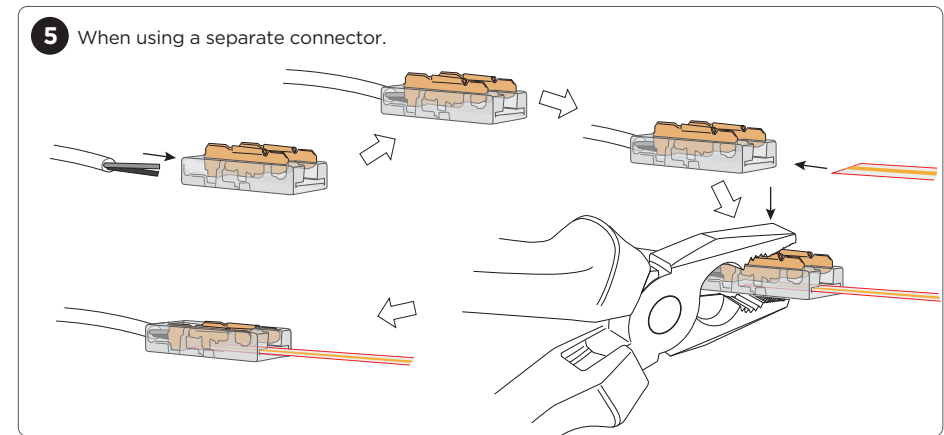
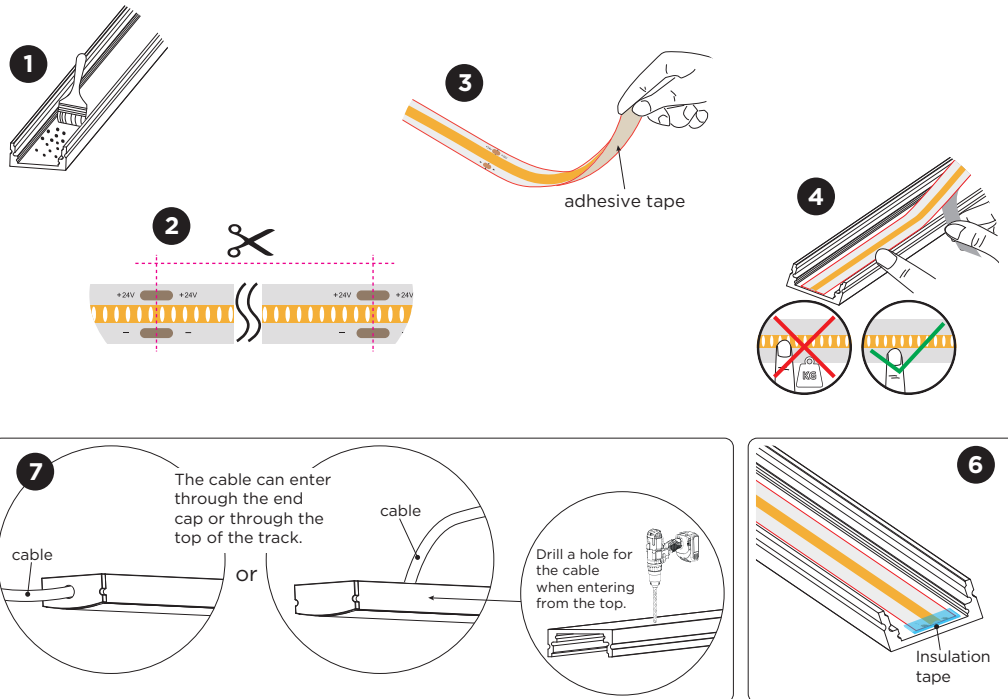

- 1** Inner profile surface must be cleaned and free from grease / dust.
- 2** LED COB strip can be cut to length:
10W/M version = every 50,00mm
15W/M version = every 31,20mm
- 3** Adhesive side on the LED COB strip for easy fixation.
- 4** LED COB strip needs to be pushed on gently and not with tools.
- 5** Fix the electrical connector to the COB LED strip as illustrated.
- 6** The non-connector side of the LED COB strip should be electrically isolated so that the LED copper conductors cannot touch the profile.
- 7** Cable can go through end cap with hole or alternatively a hole can be drilled in the profile to enter with the cable through the back side.
- 8** LED COB strip polarity needs to be respected when connecting to a driver.

ILANE 1.0

INSTALLATION INSTRUCTIONS | DECEMBER 2021

LED COB strip connectors:

from strip to driver

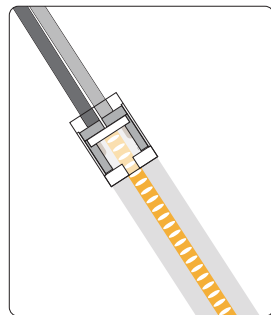
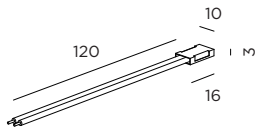

from strip to strip
e.g. in a corner

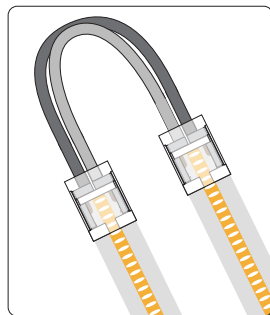
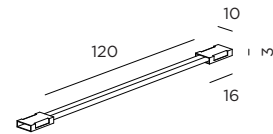

from strip to strip:
making continuous lines

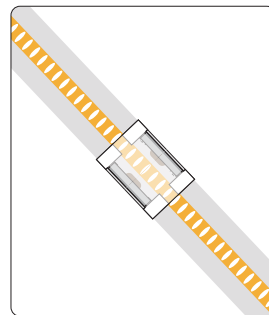
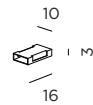

LED COB strip can be cut to length:

10W/M version = every 50mm
15W/M version = every 31,20mm

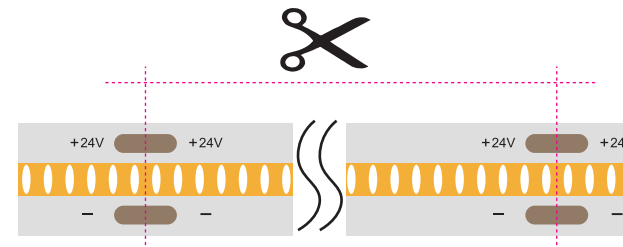

When cutting the strip it is important to cut precisely between 2 LEDs.
When an LED is exposed there is no phosphor covering the side which will show blue light coming out of the cut side of the strip.

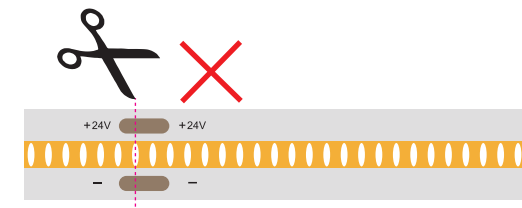
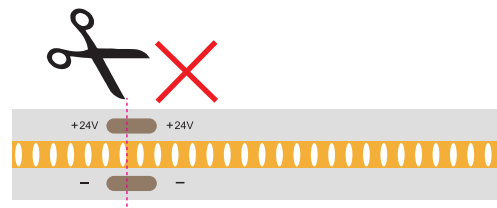
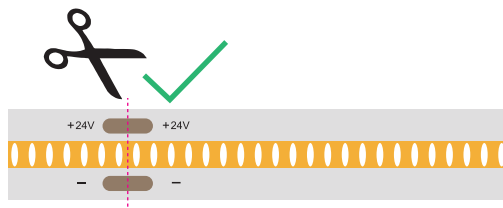

ILANE 2.0

INSTALLATION INSTRUCTIONS | JANUARY 2021

COMPONENTS

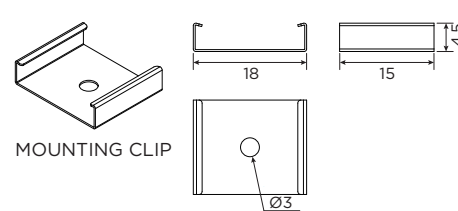
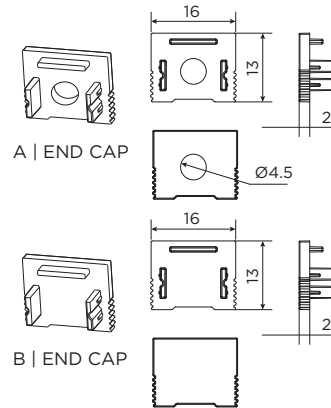
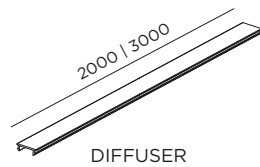
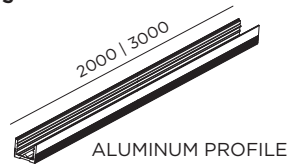

DIMENSIONS

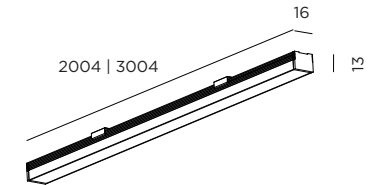
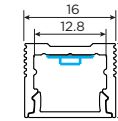

model	content				
	profile	diffuser	closed end cap	end cap with hole	mounting clips
2000 mm	1	1	2	1	5
3000 mm	1	1	2	1	7

CEILING SURFACE INSTALLATION :

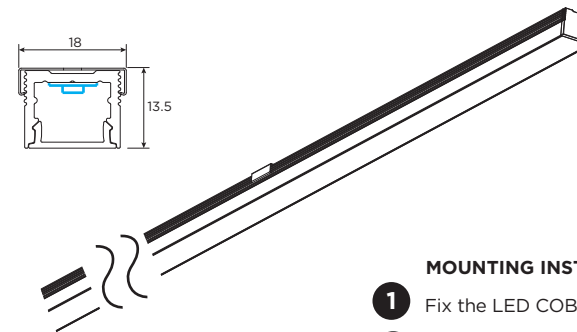
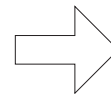
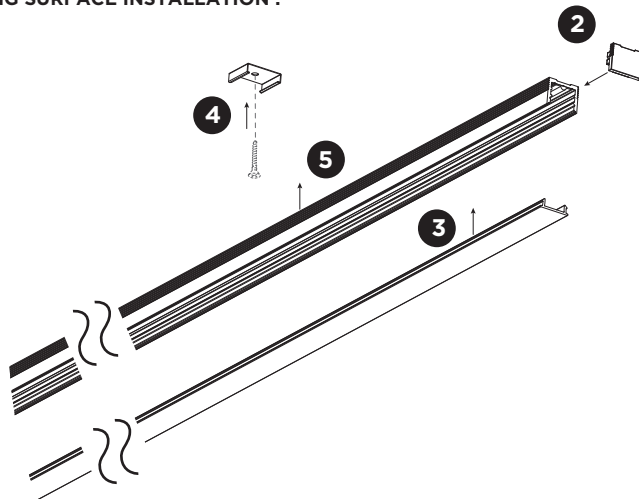

MOUNTING INSTRUCTION

- 1 Fix the LED COB strip into the profile (see page 3).
- 2 Mount the end caps on the ends of the profile.
- 3 Insert the diffuser into the profile.
- 4 Fix the mounting clips to the ceiling with screws every half meter (screws are not included). Alternatively fix the profile to the surface by means of double sided tape or glue.
- 5 Push the assembled profile into the mounting clips.

ILANE 2.0

INSTALLATION INSTRUCTIONS | JANUARY 2021

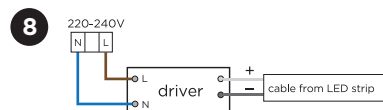
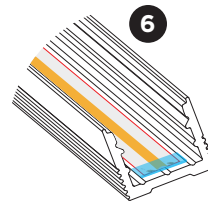
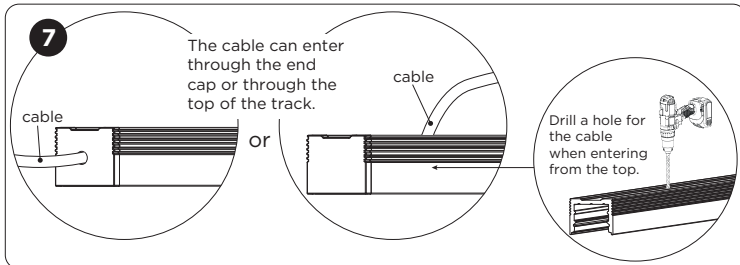
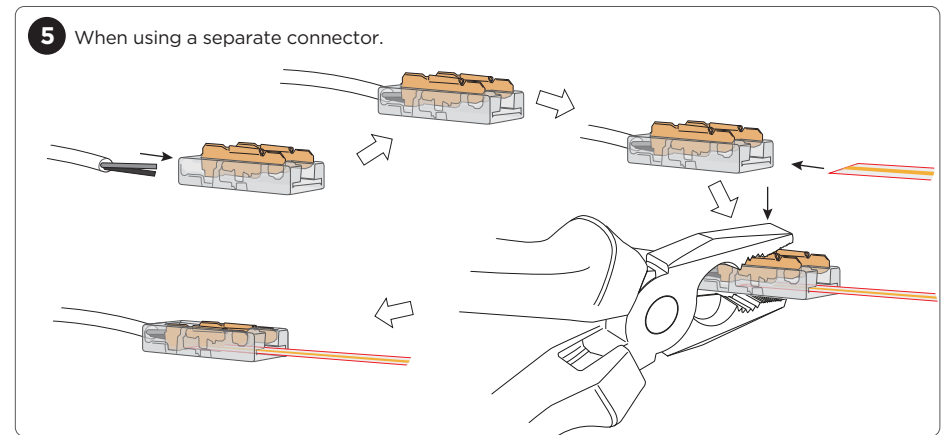
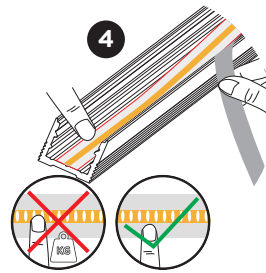
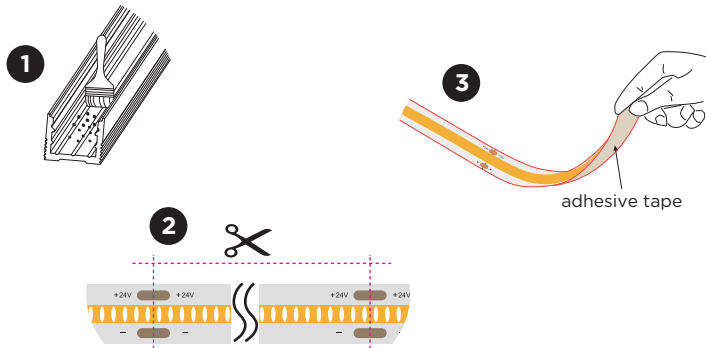

- 1 Inner profile surface must be cleaned and free from grease / dust.
- 2 LED COB strip can be cut to length:
10W/M version = every 50,00mm
15W/M version = every 31,20mm
- 3 Adhesive side on the LED COB strip for easy fixation.
- 4 LED COB strip needs to be pushed on gently and not with tools.
- 5 Fix the electrical connector to the COB LED strip as illustrated.
- 6 The non-conductor side of the LED COB strip should be electrically isolated so that the LED copper conductors cannot touch the profile.
- 7 Cable can go through end cap with hole or alternatively a hole can be drilled in the profile to enter with the cable through the back side.
- 8 LED COB strip polarity needs to be respected when connecting to a driver.

ILANE 2.0

INSTALLATION INSTRUCTIONS | JANUARY 2021

LED COB strip connectors:

from strip to driver

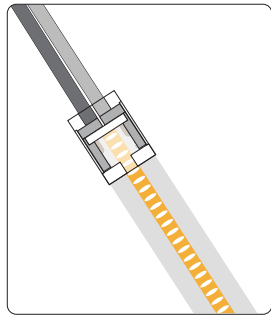
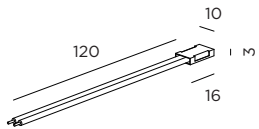

from strip to strip
e.g. in a corner

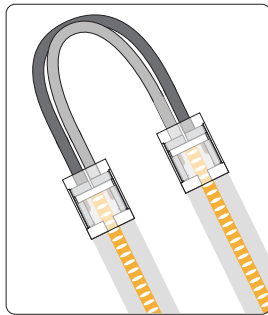
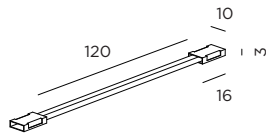

from strip to strip:
making continuous lines

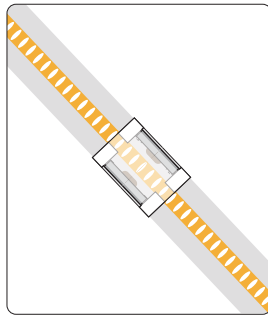
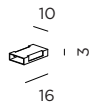

LED COB strip can be cut to length:

10W/M version = every 50mm

15W/M version = every 31,20mm

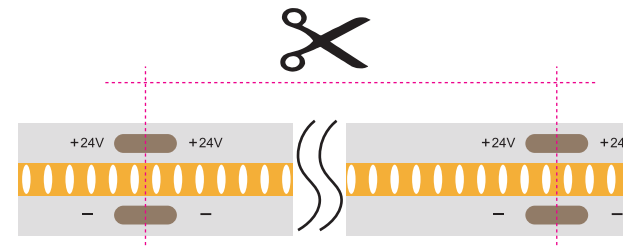

When cutting the strip it is important to cut precisely between 2 LEDs.
When an LED is exposed there is no phosphor covering the side which will show blue light coming out of the cut side of the strip.

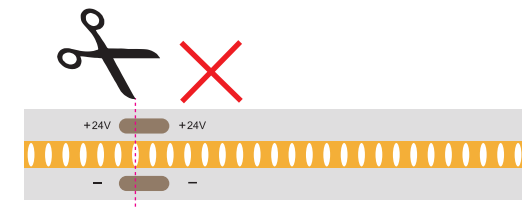
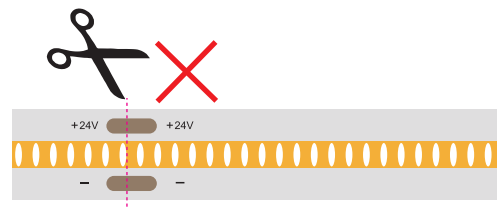
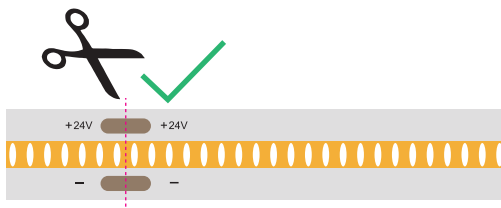

ILANE 3.0

INSTALLATION INSTRUCTIONS | JANUARY 2021

COMPONENTS

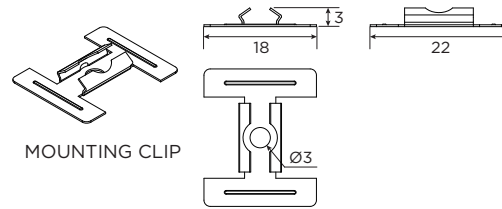
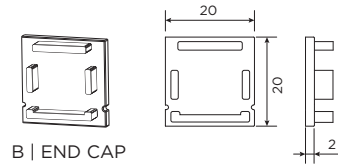
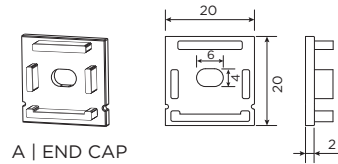
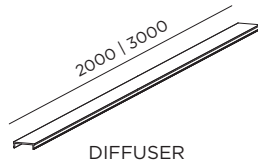
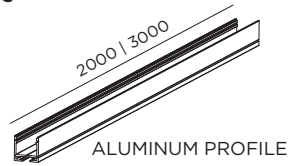

DIMENSIONS

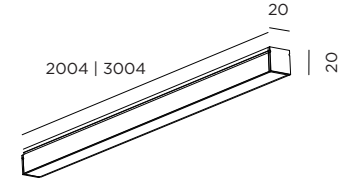
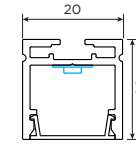

model	content				
	profile	diffuser	closed end cap	end cap with hole	mounting clips
2000 mm	1	1	2	1	5
3000 mm	1	1	2	1	7

CEILING SURFACE INSTALLATION :

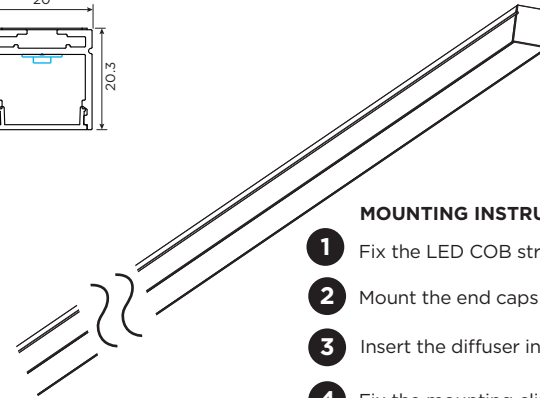
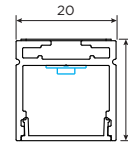
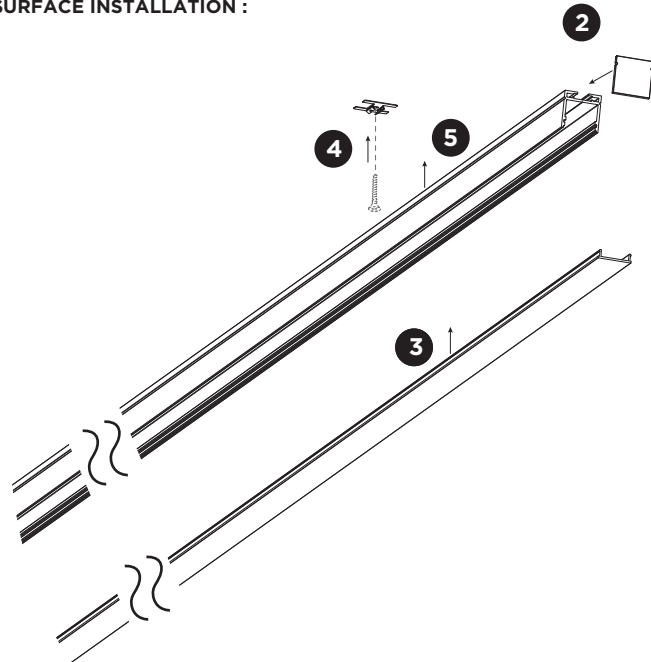

MOUNTING INSTRUCTION

- 1 Fix the LED COB strip into the profile (see page 3).
- 2 Mount the end caps on the ends of the profile.
- 3 Insert the diffuser into the profile.
- 4 Fix the mounting clips to the ceiling with screws every half meter (screws are not included).
- 5 Push the assembled profile into the mounting clips.



WEVER & DUCRÉ
LIGHTING

WEVER & DUCRÉ BV
Spinnerijstraat 99/21, 8500 Kortrijk, Belgium
weverducre.com

ILANE 3.0

INSTALLATION INSTRUCTIONS | JANUARY 2021

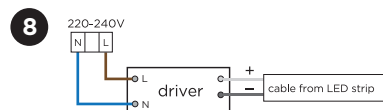
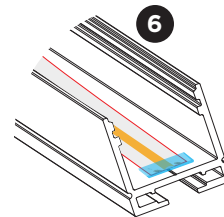
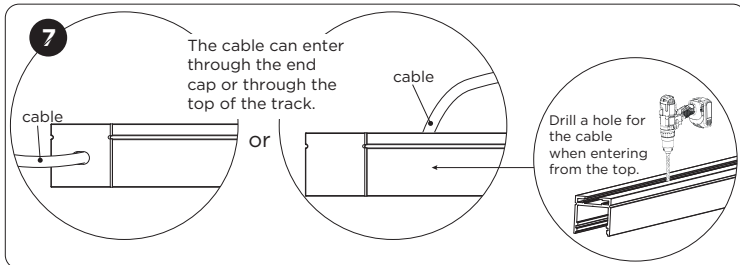
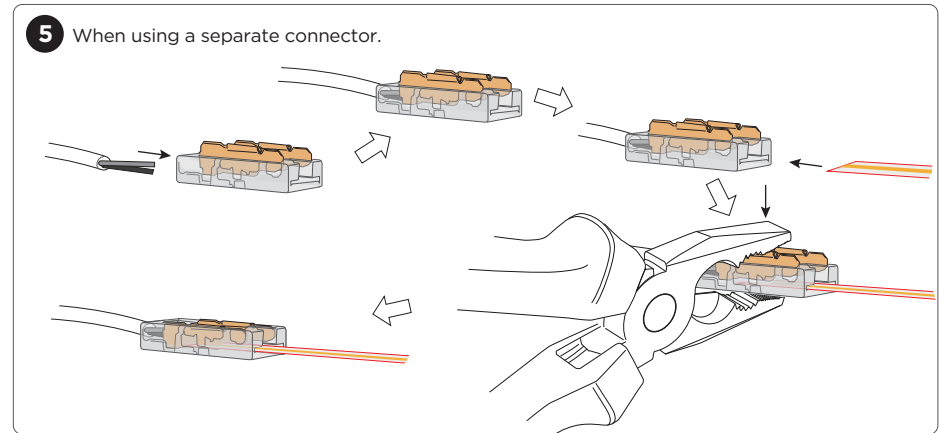
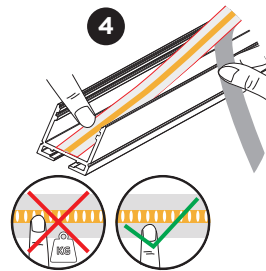
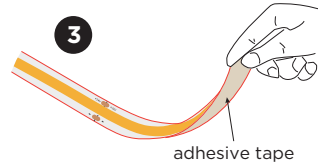
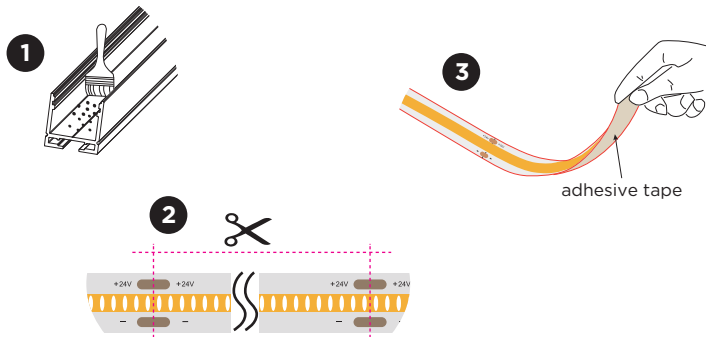

- 1 Inner profile surface must be cleaned and free from grease / dust.
- 2 LED COB strip can be cut to length:
10W/M version = every 50,00mm
15W/M version = every 31,20mm
- 3 Adhesive side on the LED COB strip for easy fixation.
- 4 LED COB strip needs to be pushed on gently and not with tools.
- 5 Fix the electrical connector to the COB LED strip as illustrated.
- 6 The non-connector side of the LED COB strip should be electrically isolated so that the LED copper conductors cannot touch the profile.
- 7 Cable can go through end cap with hole or alternatively a hole can be drilled in the profile to enter with the cable through the back side.
- 8 LED COB strip polarity needs to be respected when connecting to a driver.

ILANE 3.0

INSTALLATION INSTRUCTIONS | JANUARY 2021

LED COB strip connectors:

from strip to driver

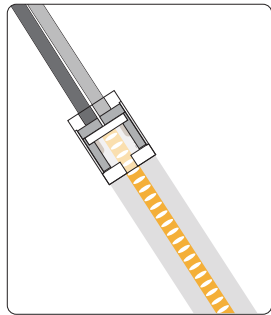
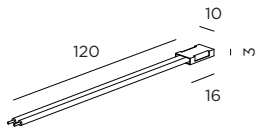

from strip to strip
e.g. in a corner

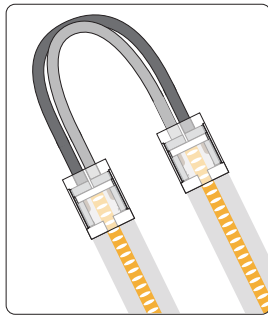
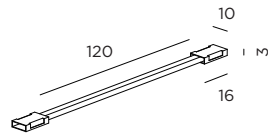

from strip to strip:
making continuous lines

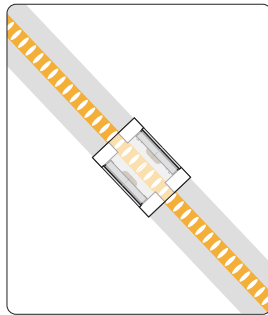
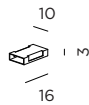

LED COB strip can be cut to length:

10W/M version = every 50mm

15W/M version = every 31,20mm

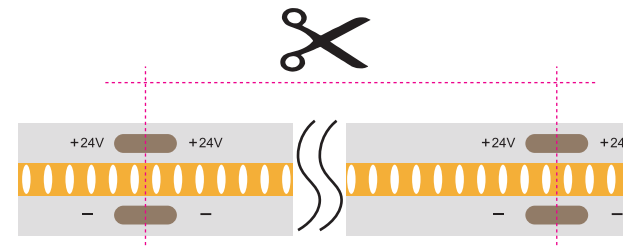

When cutting the strip it is important to cut precisely between 2 LEDs.
When an LED is exposed there is no phosphor covering the side
which will show blue light coming out of the cut side of the strip.

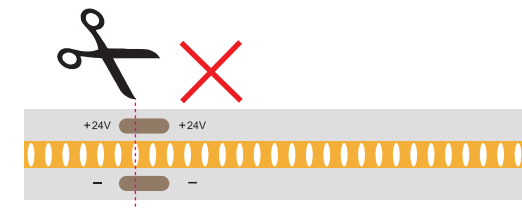
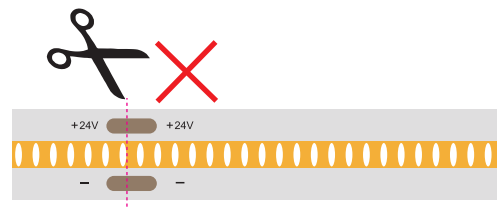
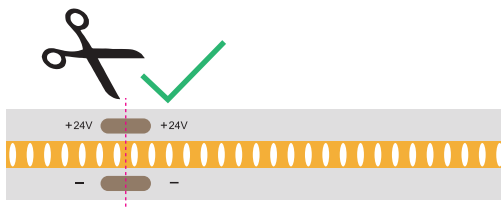

ILANE 4.0

INSTALLATION INSTRUCTIONS | MARCH 2023

COMPONENTS

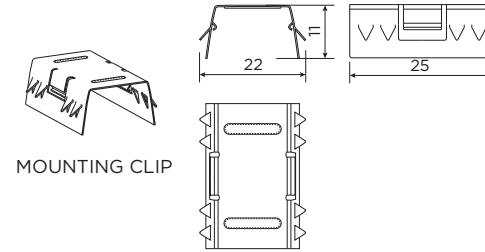
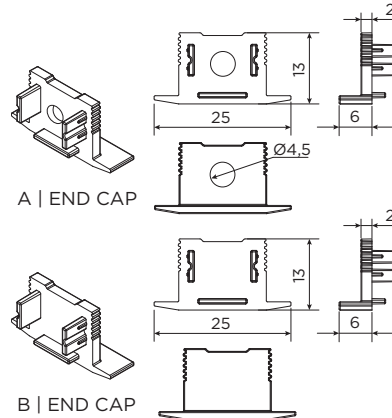
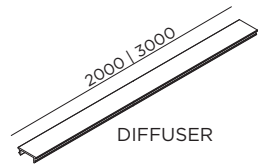
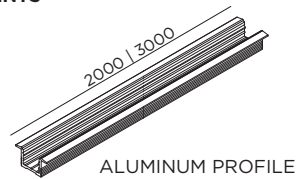

DIMENSIONS

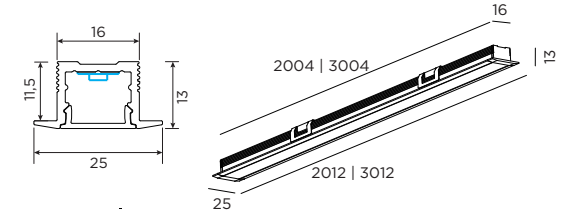

model	content				
	profile	diffuser	closed end cap	end cap with hole	mounting clips
2000mm	1	1	2	1	5
3000mm	1	1	2	1	7

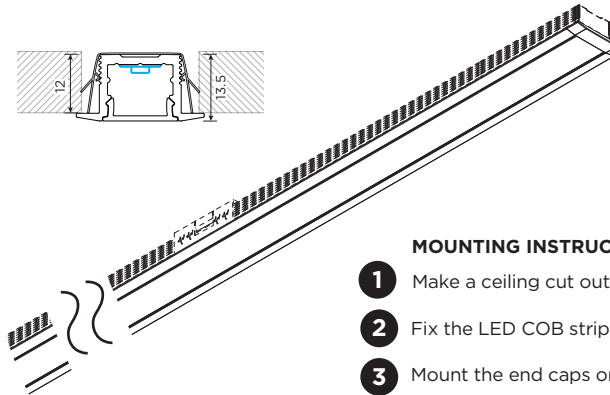
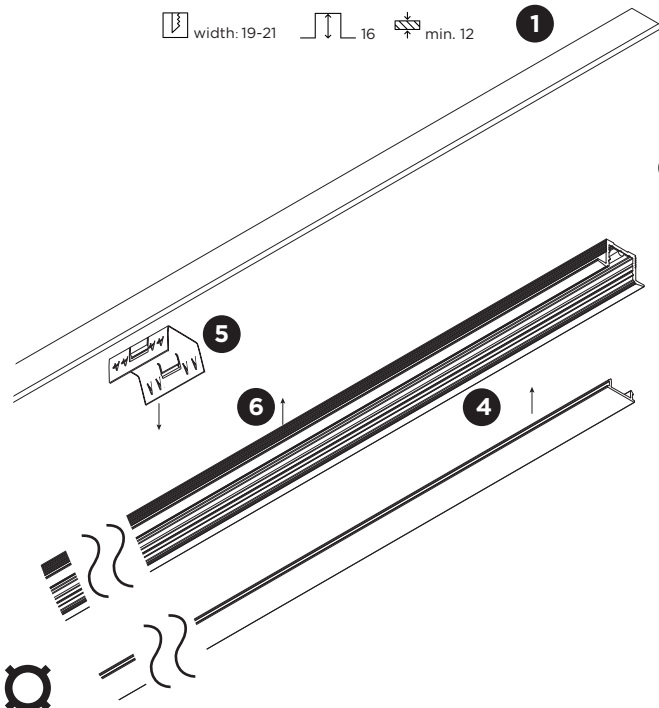

MOUNTING INSTRUCTION

- 1 Make a ceiling cut out according to the specifications.
- 2 Fix the LED COB strip into the profile (see page 2).
- 3 Mount the end caps on the ends of the profile.
- 4 Insert the diffuser into the profile.
- 5 Click the mounting clips on the profile every half meter. Alternatively fix the profile to the surface by means of double sided tape or glue.
- 6 Push the assembled profile into the ceiling cut out.

ILANE 4.0

INSTALLATION INSTRUCTIONS | MARCH 2023

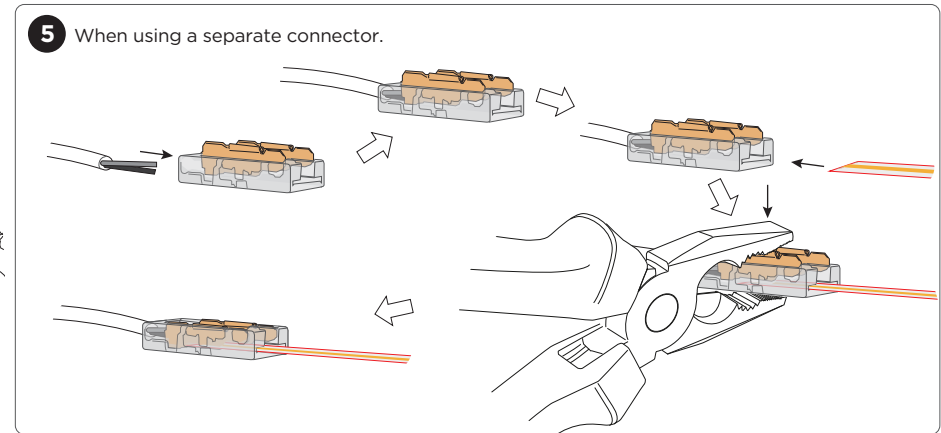
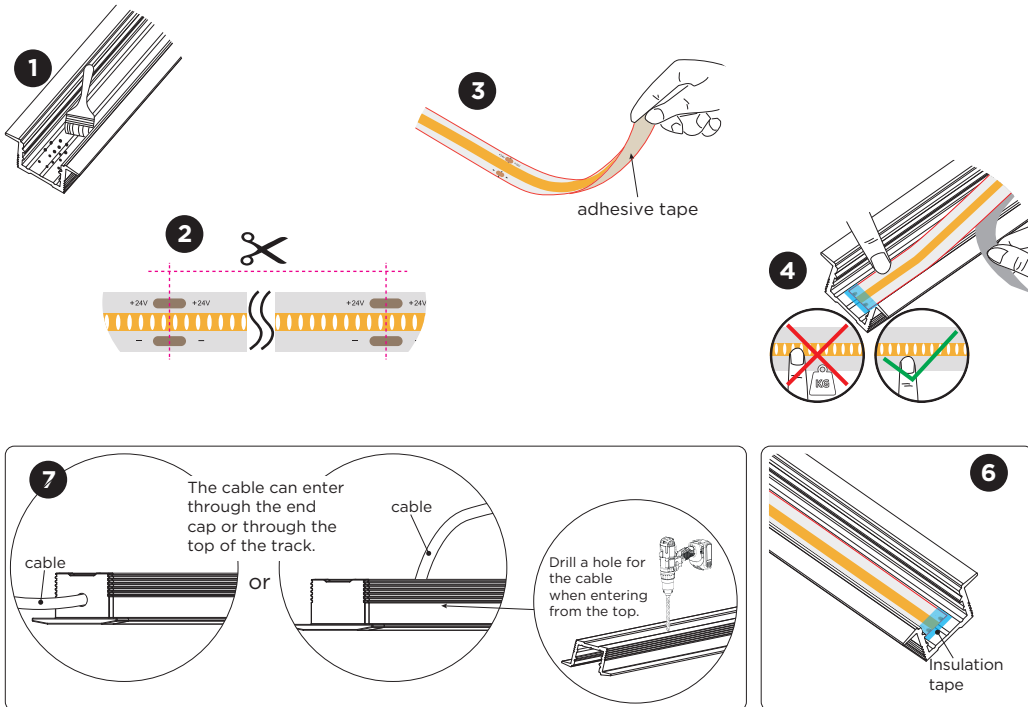

- 1** Inner profile surface must be cleaned and free from grease / dust.
- 2** LED COB strip can be cut to length:
10W/M version = every 50,00mm
15W/M version = every 31,20mm
- 3** Adhesive side on the LED COB strip for easy fixation.
- 4** LED COB strip needs to be pushed on gently and not with tools.
- 5** Fix the electrical connector to the COB LED strip as illustrated.
- 6** The non-connector side of the LED COB strip should be electrically isolated so that the LED copper conductors cannot touch the profile.
- 7** Cable can go through end cap with hole or alternatively a hole can be drilled in the profile to enter with the cable through the back side.
- 8** LED COB strip polarity needs to be respected when connecting to a driver.

ILANE 4.0

INSTALLATION INSTRUCTIONS | MARCH 2023

LED COB strip connectors:

from strip to driver

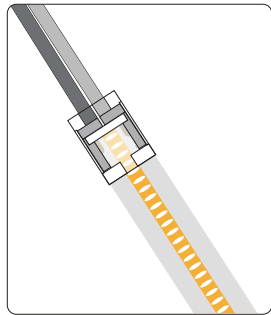
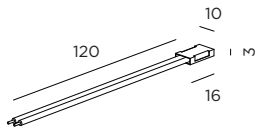

from strip to strip
e.g. in a corner

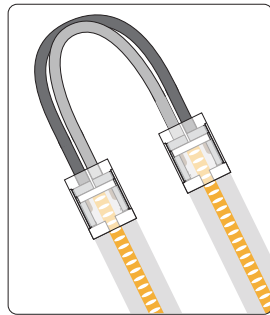
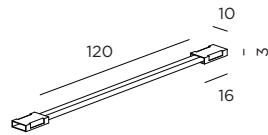

from strip to strip:
making continuous lines

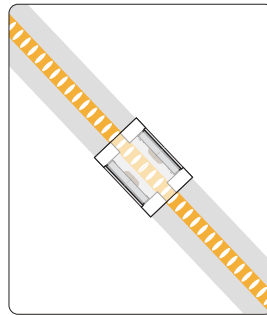
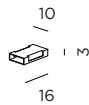

LED COB strip can be cut to length:

10W/M version = every 50mm

15W/M version = every 31,20mm

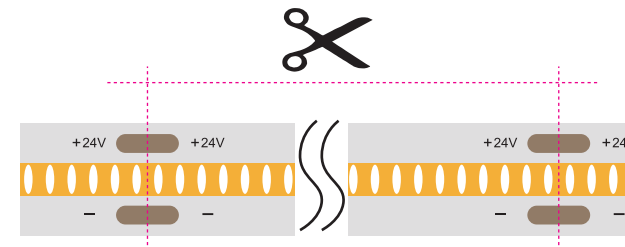

When cutting the strip it is important to cut precisely between 2 LEDs.
When an LED is exposed there is no phosphor covering the side which will show blue light coming out of the cut side of the strip.

