

5

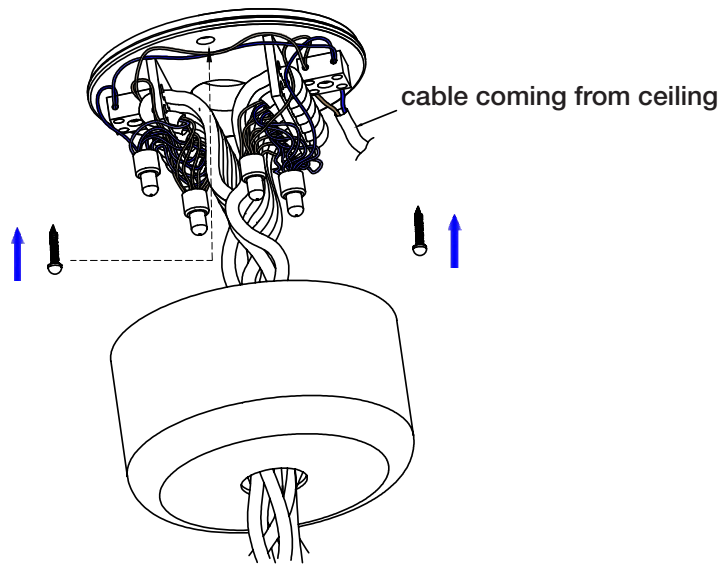

Attach the terminal to the ceiling using raw plugs and screws.

6

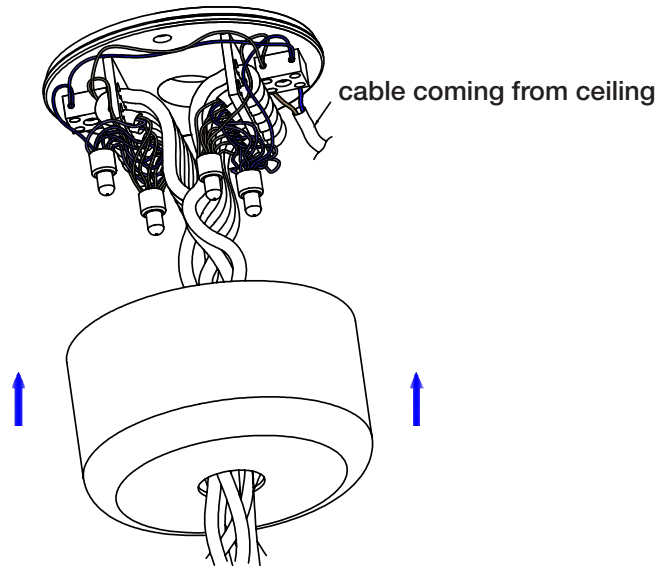

Finally, hide all cords and terminal inside the canopy.

E27

MULTIPLE
CANOPY

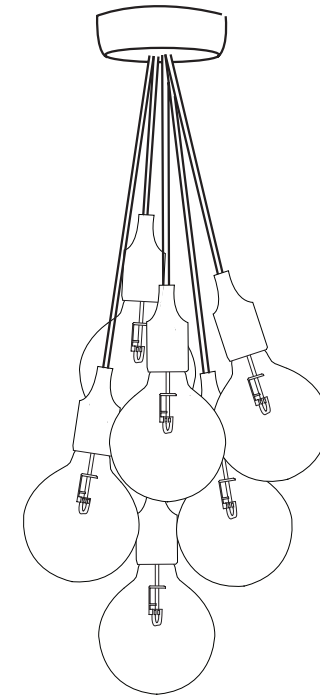

MUUTO.COM
ØSTERGADE 36-38
1100, COPENHAGEN K
DENMARK

MUUTO
New Nordic

1

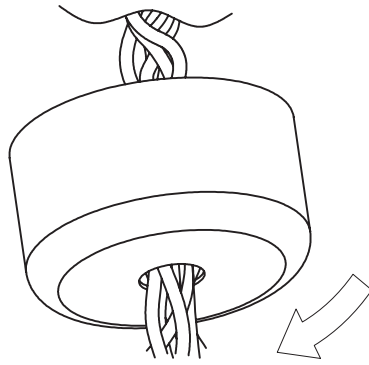

Decide the cord lengths of the E27 lamps going into the canopy.

2

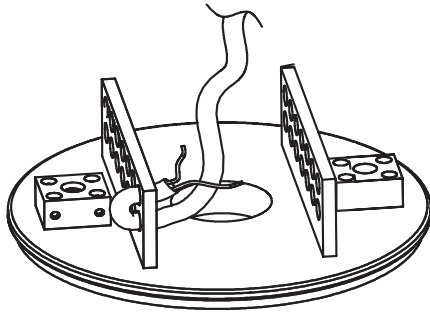

Insert the cords through the canopy holes and cut the cords at the right length, leaving out the inside cables. Leave approx. 5 cm. for installation.

3

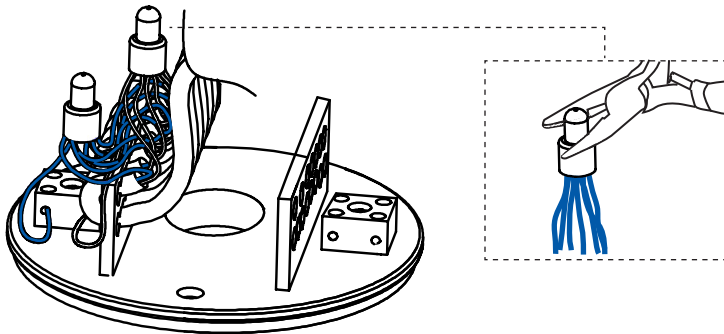

Connect all blue cables using the connecting device, making sure that all cables are touching each other inside the connecting device. Then use tool provided to squeeze the top of the capsul.

4

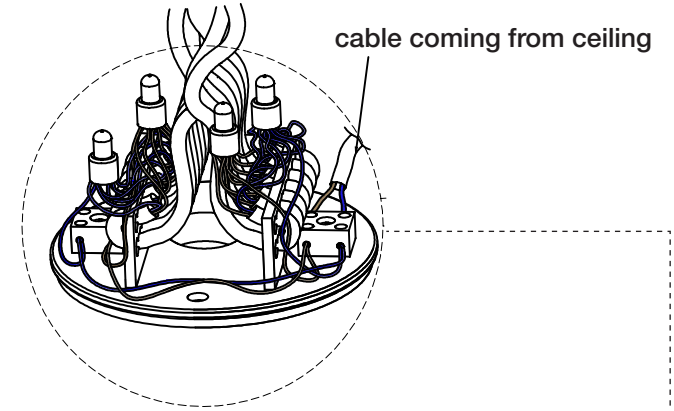

Attach the single blue cables to the terminals and tighten the screws. Repeat with the single brown cables.

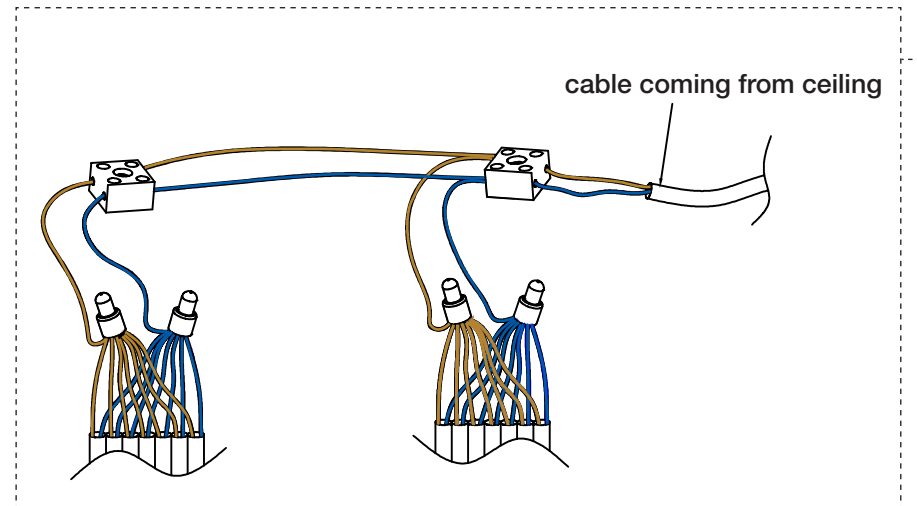

Close-up of the terminals