

BALDACHIN

27-Jul.-2016

900MM

CE IP20

White texture
Black texture

90052009
90052010

mounting plate dimension:

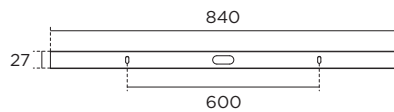

①

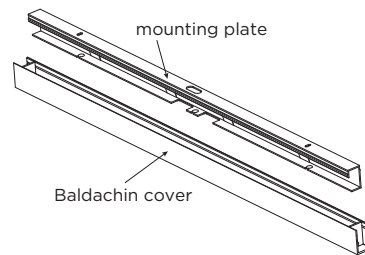

②

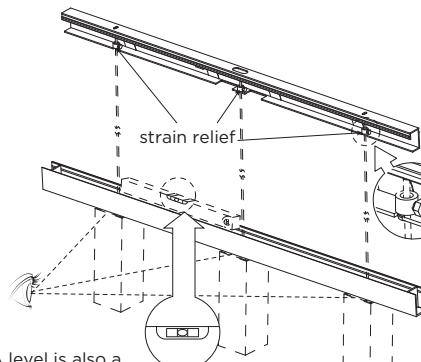

A level is also a helpful tool to ensure the hanging of the luminaires at the same height.

When the cable length is determined, please remember to tighten it.

③

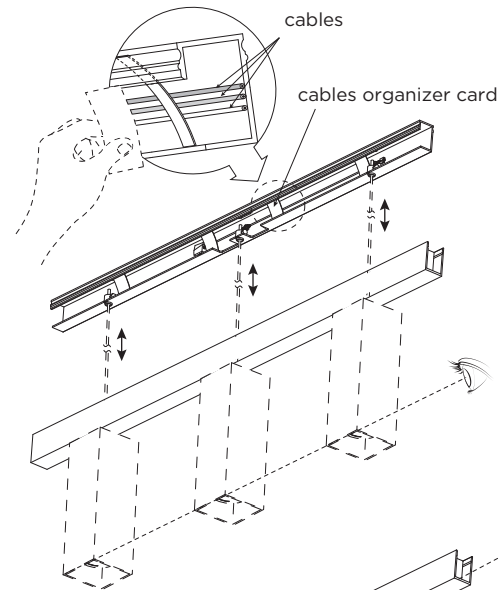

⑤

⑥

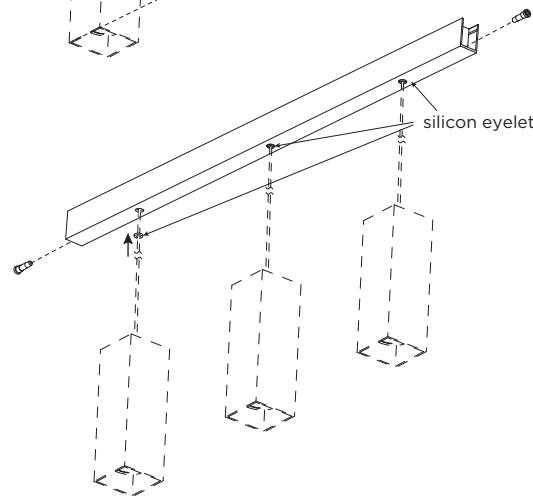

DIMENSIONS

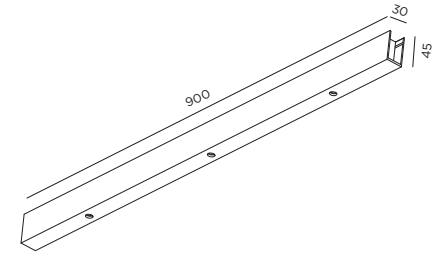

MOUNTING INSTRUCTION

- ① Remove the mounting plate from the baldachin cover.
- ② Adjust the cable of lights to desired length. If you need the lights be horizontal alignment, the baldachin cover can be a helpful judgement tool.
- ③ Fix the mounting plate on the ceiling with screws. If you need to align the orientation of the light, fine-tuning of strain relief direction to achieve adjustment.

④ POWER CONNECTION

Connect the power

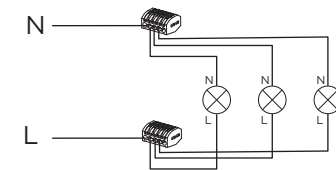

Baldachin cover earthing plug:

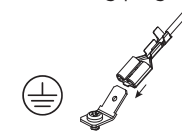

- ⑤ Lock the baldachin cover on the mounting plate with two plastic screws.
- ⑥ Put the silicon eyelets in the cable outlets.



WEVER & DUCRÉ
LIGHTING

www.weverducre.com

INSTALLATION
INSTRUCTIONS