

Collection Hollywood 1996

TECHNICAL DATA SHEET



HOLLYWOOD CHANDELIER CONICAL HCC90N

Hanging Lamp InLine

Art.nr.	Dimensions
HH25N	Ø 25cm, Height 30cm, Length steel cable 200cm, 1x E27, 4,0 kg, nickel finish, single piece
HH25N-3IL	Length 90cm, Width 25cm, Height 30cm, Length steel cable 200cm, 3x E27, 34,0 kg, nickel finish
HH25N-4IL	Length 145cm, Width 25cm, Height 30cm, Length steel cable 200cm, 4x E27, 37,0 kg, nickel finish
HH25N-5IL	Length 190cm, Width 25cm, Height 30cm, Length steel cable 200cm, 5x E27, 40,0 kg, nickel finish
HH25N-6IL	Length 235cm, Width 25cm, Height 30cm, Length steel cable 200cm, 6x E27, 43,0 kg, nickel finish

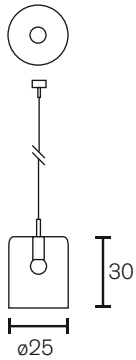

Hanging Lamp Long

Art.nr.	Dimensions
HHL100W	Length 100cm, Width 25cm, Height 30cm, Length steel cable 200cm, 4x E27, 13,0 kg, white finish
HHL100N	Length 100cm, Width 25cm, Height 30cm, Length steel cable 200cm, 4x E27, 13,0 kg, nickel finish
HHL125W	Length 125cm, Width 25cm, Height 30cm, Length steel cable 200cm, 5x E27, 18,0 kg, white finish
HHL125N	Length 125cm, Width 25cm, Height 30cm, Length steel cable 200cm, 5x E27, 18,0 kg, nickel finish
HHL150W	Length 150cm, Width 25cm, Height 30cm, Length steel cable 200cm, 6x E27, 18,0 kg, white finish
HHL150N	Length 150cm, Width 25cm, Height 30cm, Length steel cable 200cm, 6x E27, 18,0 kg, nickel finish
HHL175W	Length 175cm, Width 25cm, Height 30cm, Length steel cable 200cm, 7x E27, 21,0 kg, white finish
HHL175N	Length 175cm, Width 25cm, Height 30cm, Length steel cable 200cm, 7x E27, 21,0 kg, nickel finish
HHL200W	Length 200cm, Width 25cm, Height 30cm, Length steel cable 200cm, 8x E27, 25,0 kg, white finish
HHL200N	Length 200cm, Width 25cm, Height 30cm, Length steel cable 200cm, 8x E27, 25,0 kg, nickel finish

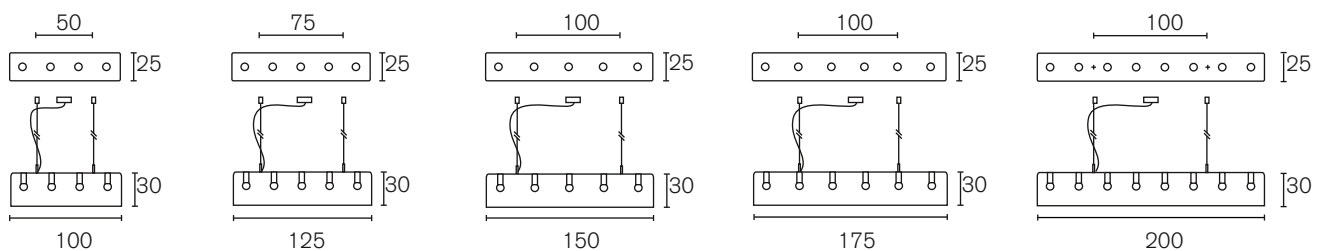

All hanging lamps are supplied with 2 meter electrical cable, 2 meter steel cable and a ceiling shade.
The Hollywood Hanging Lamp Long is supplied with a small ceiling shade. Long ceiling shade with two steel cable connections available on request.

Hanging Lamp Block

Art.nr.	Dimensions
HCC50W	Length 40cm, Width 40cm, Height 50cm, Length chain 170cm, 1x E27, 13,0 kg, white finish
HCC50N	Length 40cm, Width 40cm, Height 50cm, Length chain 170cm, 1x E27, 13,0 kg, nickel finish

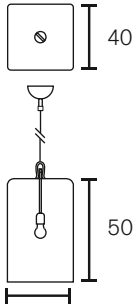

Chandelier Round

Art.nr.	Dimensions
HC80W	Ø 80cm, Height 25cm, Length chain 170cm, 6x E14, 11,0 kg, white finish
HC80N	Ø 80cm, Height 25cm, Length chain 170cm, 6x E14, 11,0 kg, nickel finish
HC100W	Ø 100cm, Height 25cm, Length chain 170cm, 8x E14, 25,0 kg, white finish
HC100N	Ø 100cm, Height 25cm, Length chain 170cm, 8x E14, 25,0 kg, nickel finish
HC120W	Ø 120cm, Height 25cm, Length chain 170cm, 10x E14, 28,0 kg, white finish
HC120N	Ø 120cm, Height 25cm, Length chain 170cm, 10x E14, 28,0 kg, nickel finish

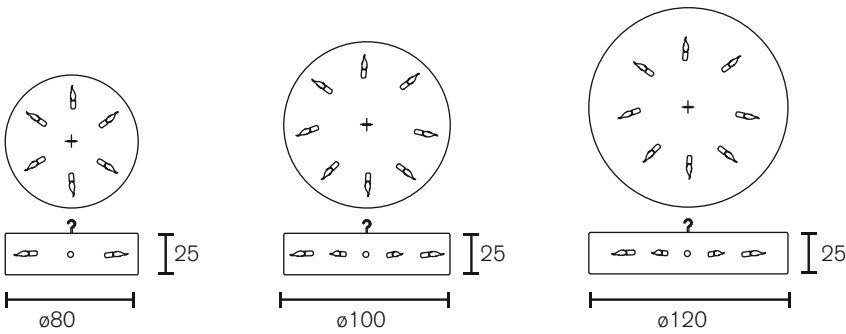

Chandelier Candlestick Round

Art.nr.	Dimensions
HCCH10X10W	Ø 100cm, Height 40cm, Length chain 170cm, 12x E14, 25,0 kg, white finish
HCCH10X10N	Ø 100cm, Height 40cm, Length chain 170cm, 12x E14, 25,0 kg, nickel finish
HCCH12X12W	Ø 120cm, Height 40cm, Length chain 170cm, 12x E14, 25,0 kg, white finish
HCCH12X12N	Ø 120cm, Height 40cm, Length chain 170cm, 12x E14, 25,0 kg, nickel finish

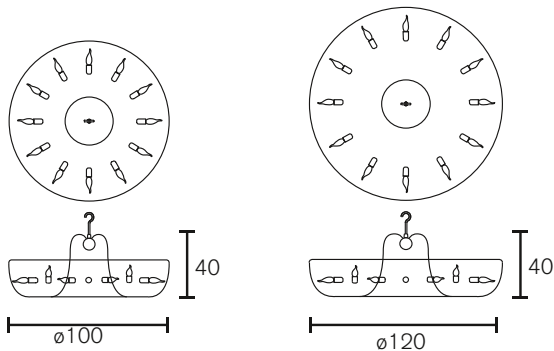

All chandeliers are supplied with 1,7 meter chain, 2 meter electrical cable and a ceiling shade.

Chandelier Oval

Art.nr.	Dimensions
HOC60W	Length 120cm, Width 60cm, Height 25cm, Length chain 170cm, 8x E14, 13,0 kg, white finish
HOC60N	Length 120cm, Width 60cm, Height 25cm, Length chain 170cm, 8x E14, 13,0 kg, nickel finish
HOC70W	Length 140cm, Width 70cm, Height 25cm, Length chain 170cm, 8x E14, 17,0 kg, white finish
HOC70N	Length 140cm, Width 70cm, Height 25cm, Length chain 170cm, 8x E14, 17,0 kg, nickel finish
HOC80W	Length 160cm, Width 80cm, Height 25cm, Length chain 170cm, 8x E14, 24,0 kg, white finish
HOC80N	Length 160cm, Width 80cm, Height 25cm, Length chain 170cm, 8x E14, 24,0 kg, nickel finish
HOC100W	Length 200cm, Width 100cm, Height 25cm, Length chain 170cm, 12x E14, 38,0 kg, white finish
HOC100N	Length 200cm, Width 100cm, Height 25cm, Length chain 170cm, 12x E14, 38,0 kg, nickel finish

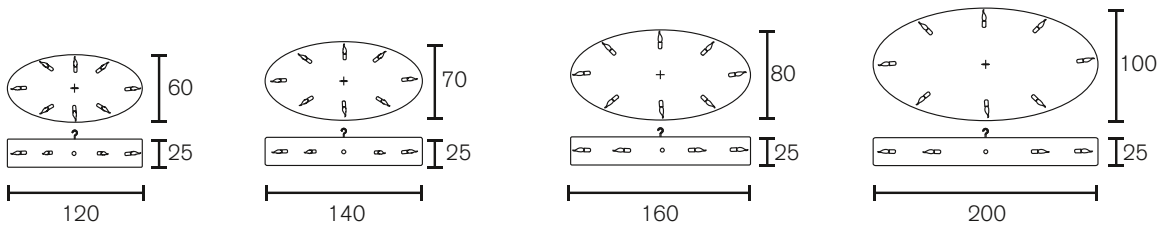

Chandelier Conical

Art.nr.	Dimensions
HCC40W	Ø 40cm, Height 60cm, Length chain 170cm, 6x E14, 6,0 kg, white finish
HCC40N	Ø 40cm, Height 60cm, Length chain 170cm, 6x E14, 6,0 kg, nickel finish
HCC60W	Ø 60cm, Height 100cm, Length chain 170cm, 8x E14, 16,0 kg, white finish
HCC60N	Ø 60cm, Height 100cm, Length chain 170cm, 8x E14, 16,0 kg, nickel finish
HCC90W	Ø 90cm, Height 130cm, Length chain 170cm, 16x E14, 27,0 kg, white finish
HCC90N	Ø 90cm, Height 130cm, Length chain 170cm, 16x E14, 27,0 kg, nickel finish

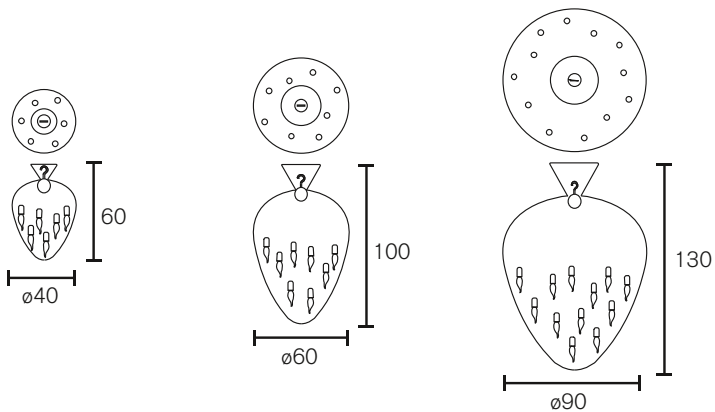

All chandeliers are supplied with 1,7 meter chain, 2 meter electrical cable and a ceiling shade.

Chandelier Conical Oval

Art.nr.	Dimensions
HCCO120W	Length 120cm, Width 55cm, Height 75cm, Length chain 170cm, 12x E14, 23,0 kg, white finish
HCCO120N	Length 120cm, Width 55cm, Height 75cm, Length chain 170cm, 12x E14, 23,0 kg, nickel finish
HCCO140W	Length 140cm, Width 55cm, Height 85cm, Length chain 170cm, 14x E14, 26,0 kg, white finish
HCCO140N	Length 140cm, Width 55cm, Height 85cm, Length chain 170cm, 14x E14, 26,0 kg, nickel finish
HCCO160W	Length 160cm, Width 55cm, Height 85cm, Length chain 170cm, 14x E14, 30,0 kg, white finish
HCCO160N	Length 160cm, Width 55cm, Height 85cm, Length chain 170cm, 14x E14, 30,0 kg, nickel finish

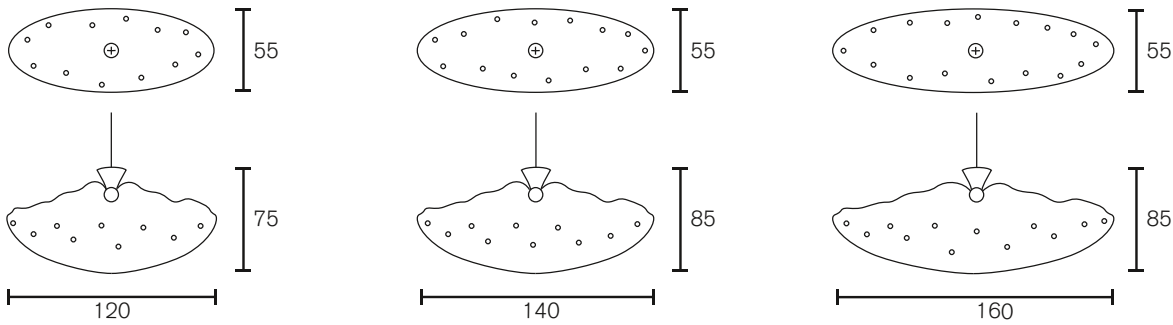

Ceiling Chandelier

Art.nr.	Dimensions
HPH40W	Ø 40cm, Height 40cm, 6x E14, 5,0 kg, white finish
HPH40N	Ø 40cm, Height 40cm, 6x E14, 5,0 kg, nickel finish
HPH60W	Ø 60cm, Height 60cm, 10x E14, 8,0 kg, white finish
HPH60N	Ø 60cm, Height 60cm, 10x E14, 8,0 kg, nickel finish
HPH80W	Ø 80cm, Height 80cm, 12x E14, 11,0 kg, white finish
HPH80N	Ø 80cm, Height 80cm, 12x E14, 11,0 kg, nickel finish
HPH100W	Ø 100cm, Height 80cm, 14x E14, 15,0 kg, white finish
HPH100N	Ø 100cm, Height 80cm, 14x E14, 15,0 kg, nickel finish
HPH120W	Ø 120cm, Height 80cm, 14x E14, 17,0 kg, white finish
HPH120N	Ø 120cm, Height 80cm, 14x E14, 17,0 kg, nickel finish

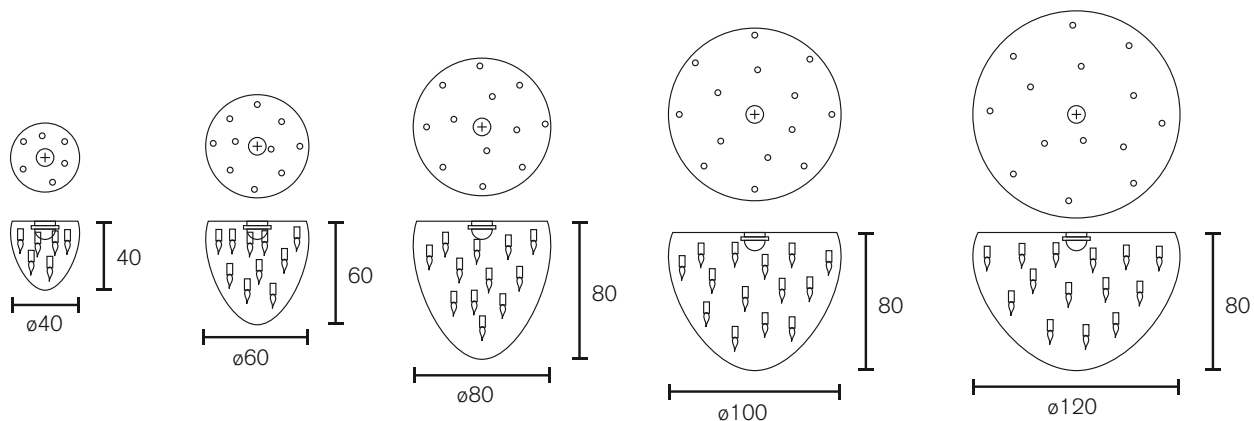

All hanging lamps are supplied with 1,7 meter chain, 2 meter electrical cable and a ceiling shade.

Ceiling Lamp Round

Art.nr.	Dimensions
HP40NH	Ø 40cm, Height 25cm, 6x G9, 3,0 kg, nickel finish
HP60W	Ø 60cm, Height 25cm, 6x E14, 6,0 kg, white finish
HP60N	Ø 60cm, Height 25cm, 6x E14, 6,0 kg, nickel finish
HP80W	Ø 80cm, Height 25cm, 6x E14, 10,0 kg, white finish
HP80N	Ø 80cm, Height 25cm, 6x E14, 10,0 kg, nickel finish
HP100W	Ø 100cm, Height 25cm, 8x E14, 16,0 kg, white finish
HP100N	Ø 100cm, Height 25cm, 8x E14, 16,0 kg, nickel finish
HP120W	Ø 120cm, Height 25cm, 10x E14, 24,0 kg, white finish
HP120N	Ø 120cm, Height 25cm, 10x E14, 24,0 kg, nickel finish

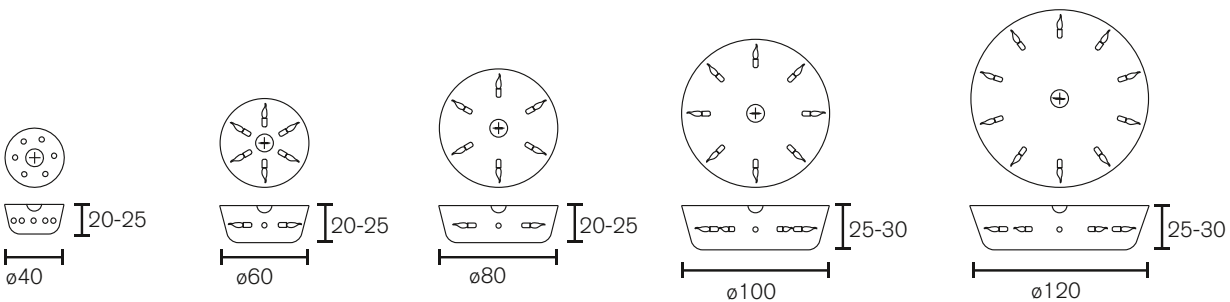

Wall Lamp

Art.nr.	Dimensions
HW20W-L	Width 20cm, Height 45cm, Depth 15cm, 1x E14, 1,0 kg, white finish, left version
HW20W-R	Width 20cm, Height 45cm, Depth 15cm, 1x E14, 1,0 kg, white finish, right version
HW20N-L	Width 20cm, Height 45cm, Depth 15cm, 1x E14, 1,0 kg, nickel finish, left version
HW20N-R	Width 20cm, Height 45cm, Depth 15cm, 1x E14, 1,0 kg, nickel finish, right version
HW30W-L	Width 30cm, Height 50cm, Depth 15cm, 1x E14, 2,0 kg, white finish, left version
HW30W-R	Width 30cm, Height 50cm, Depth 15cm, 1x E14, 2,0 kg, white finish, right version
HW30N-L	Width 30cm, Height 50cm, Depth 15cm, 1x E14, 2,0 kg, nickel finish, left version
HW30N-R	Width 30cm, Height 50cm, Depth 15cm, 1x E14, 2,0 kg, nickel finish, right version

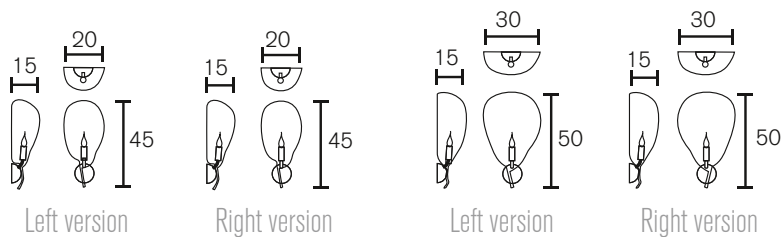

Wall Lamp Block

Art.nr.	Dimensions
HW45N	Width 20cm, Height 45cm, Depth 25cm, 1x E27, 6,0 kg, nickel finish

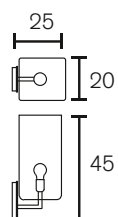
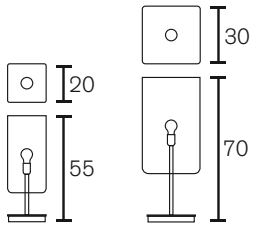

Table Lamp Block

Art.nr.	Dimensions
HT55W	Length 20cm, Width 20cm, Height 55cm, 1x E27, 6,5 kg, white finish
HT55N	Length 20cm, Width 20cm, Height 55cm, 1x E27, 6,5 kg, nickel finish
HT70W	Length 30cm, Width 30cm, Height 70cm, 1x E27, 14,0 kg, white finish
HT70N	Length 30cm, Width 30cm, Height 70cm, 1x E27, 14,0 kg, nickel finish



Floor Lamp Block

Art.nr.	Dimensions
HF170W	Length 30cm, Width 30cm, Height 170cm, 1x E27, 18,0 kg, white finish
HF170N	Length 30cm, Width 30cm, Height 170cm, 1x E27, 18,0 kg, nickel finish
HF190W	Length 40cm, Width 40cm, Height 190cm, 1x E27, 23,0 kg, white finish
HF190N	Length 40cm, Width 40cm, Height 190cm, 1x E27, 23,0 kg, nickel finish

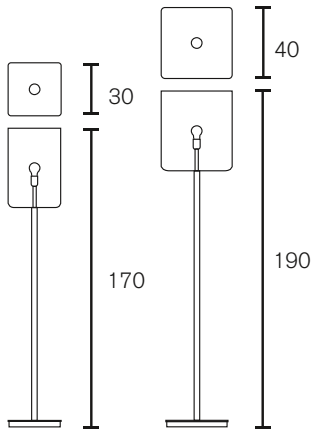

All floor- and table lamps are supplied with a dimmer.

BRAND VAN EGMOND B.V. Nikkelstraat 41, 1411 AH Naarden, the Netherlands

+31 (0)35 692 12 59

+31 (0)35 691 17 25

info@brandvanegmond.com

www.brandvanegmond.com

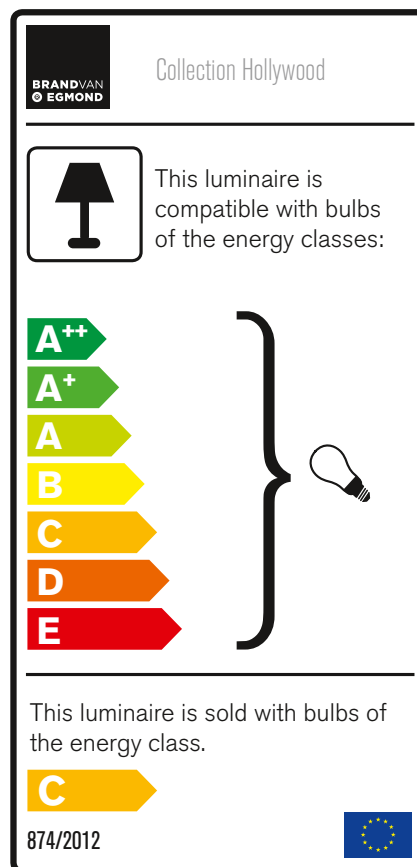

Cleaning instruction

1. Cleaning by expert is advised.
2. Cut power before cleaning.
3. Clean with a soft dry cloth only or use a feather duster.
4. When using cleaning agent use a multi-surface spray cleaner on a soft cloth. Do not use abrasive cloths or substances and always read the label of any product you wish to use on or near a lamp by BRAND VAN EGMOND.