

# Qbini Frame 4X

141740XX

Scan for installation video or go to [supermodular.com/en/qbini-frame/](http://supermodular.com/en/qbini-frame/)

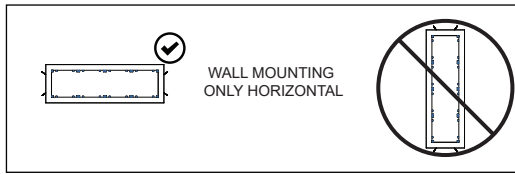

USE INCLUDED CARDBOARD TEMPLATE TO CUT SQUARE HOLE

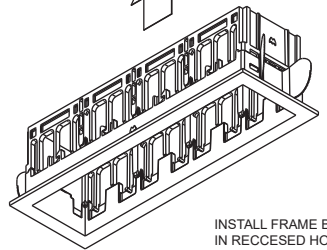
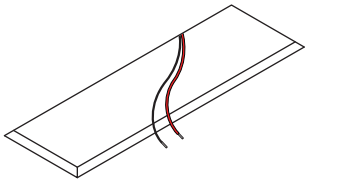
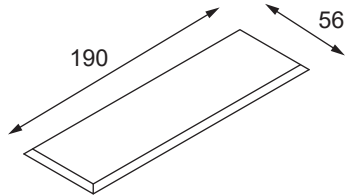

INSTALL FRAME BY PUSHING IN RECESSED HOLE

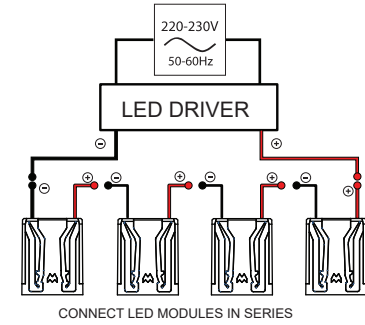

CONNECT LED MODULES IN SERIES

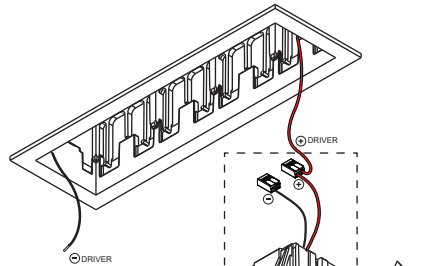

MODULE NEEDS TO BE ORDERED SEPARATELY

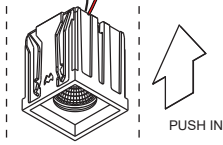

PUSH IN

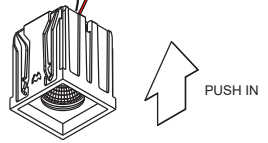
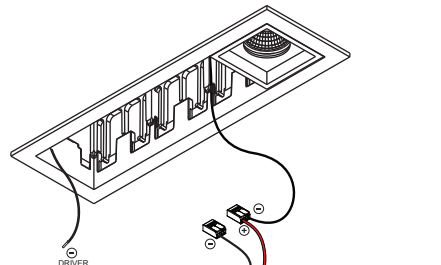

PUSH IN

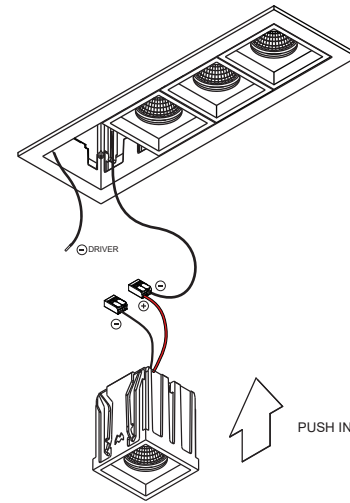

PUSH IN

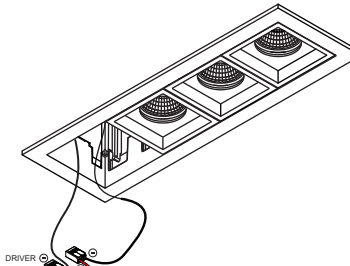

DRIVER

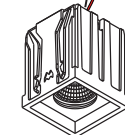

PUSH IN

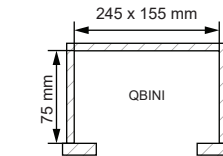

QBINI

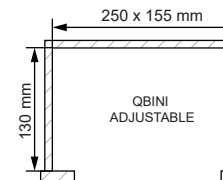

QBINI ADJUSTABLE

FIRST LATCHED POSITION

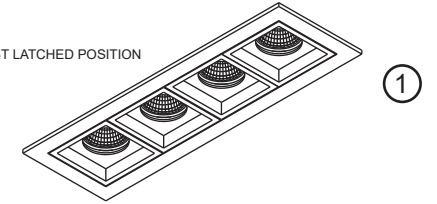

1

PUSH module UP for SECOND LATCHED POSITION



2

PUSH module further UP for RELEASE POSITION

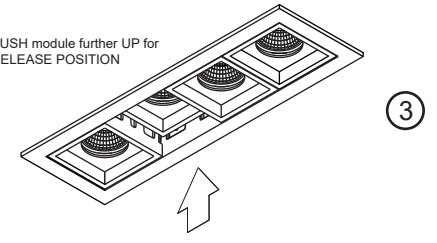

3

PULL module DOWN to remove

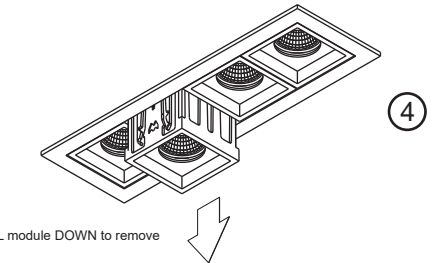

4



05 - 27/02/2023