

# TYPHA

DESIGN BY CALVI BRAMBILLA

CODE

**285. 04**

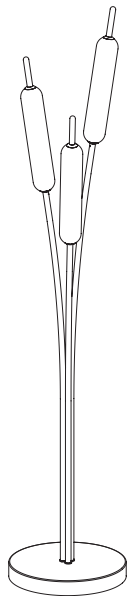

# IL FANALE



**IT** ISTRUZIONI DI INSTALLAZIONE ED IMPIEGO

**EN** INSTALLATION AND USE INSTRUCTIONS

CODE  
285.04



LED 42W 2700K 750lm CRI 90 220-240 V 50/60 Hz IP 20

**IT** Regolabile con dimmer a taglio di fase IGBT o triac.  
Utilizzare preferibilmente dimmer dei marchi più noti.

**EN** Adjustable with IGBT or triac phase cut dimmer.  
Preferably use dimmers of the best known brands.

**IT**  **ATTENZIONE!** - Prima di installare o fare manutenzione al prodotto è necessario visionare le **Avvertenze generali** utilizzando il **QR code** in copertina.

**EN**  **WARNING!** - Before installing or maintaining the product it is necessary to read the **General Warnings** using the **QR code** on the cover.

1

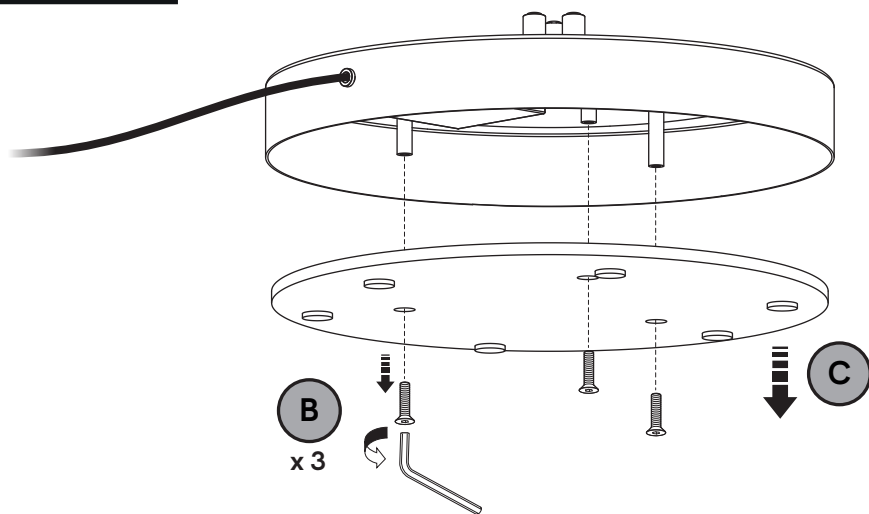
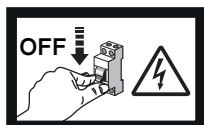

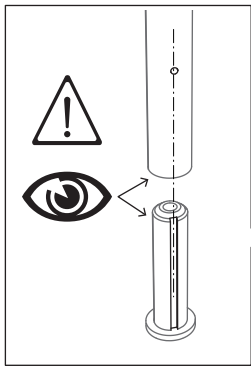
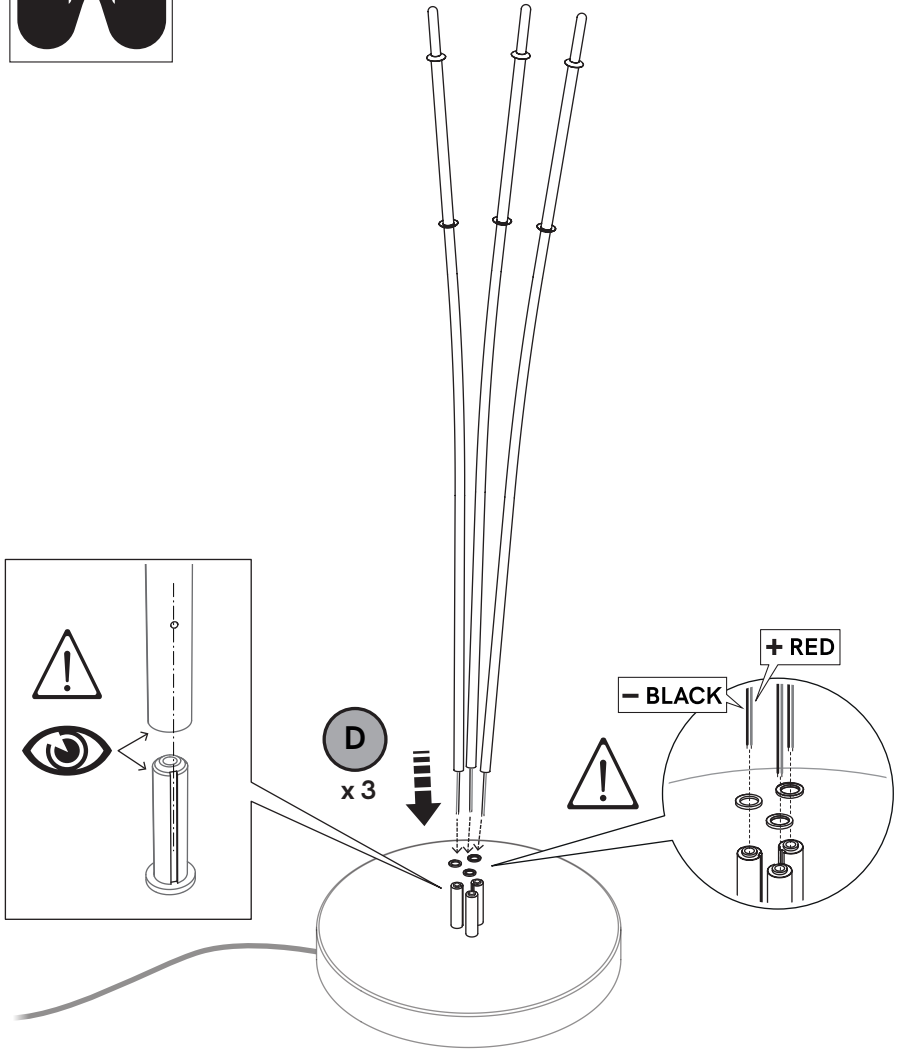

3

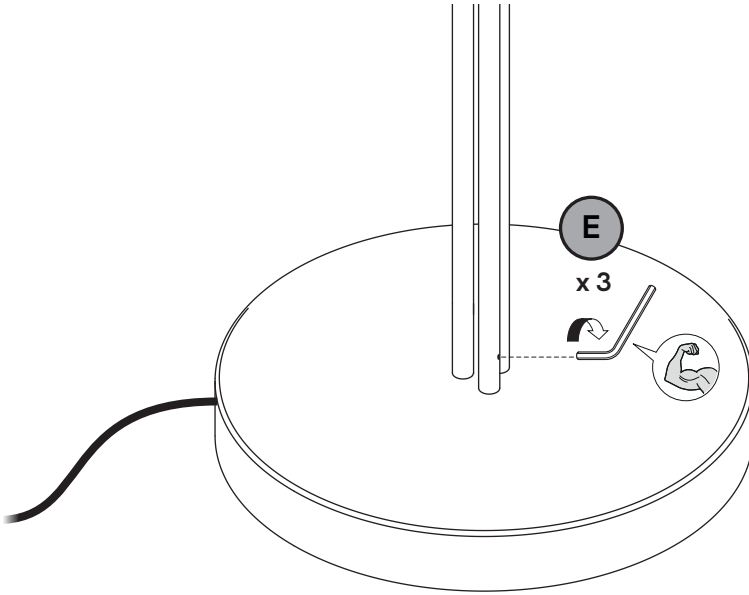

4

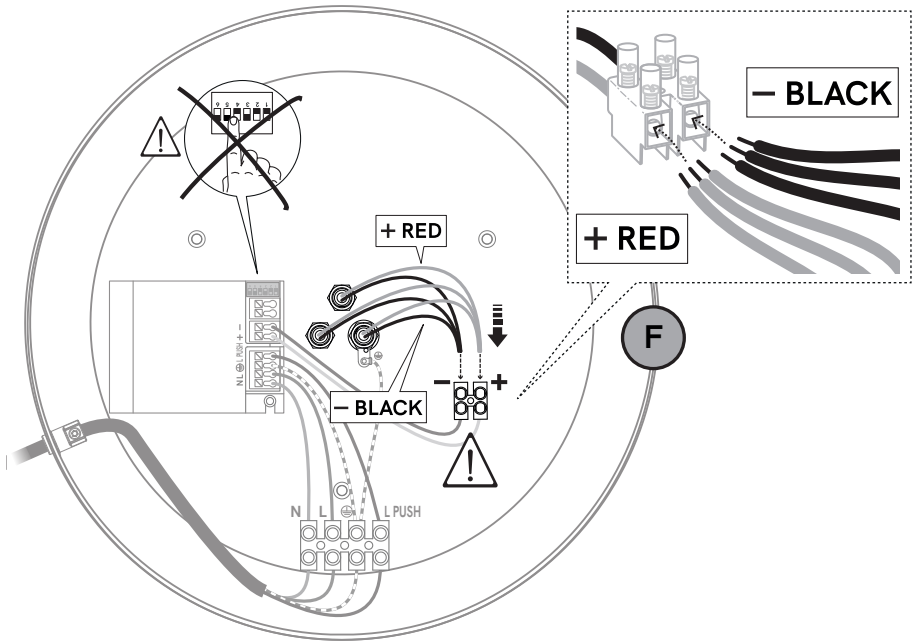

5

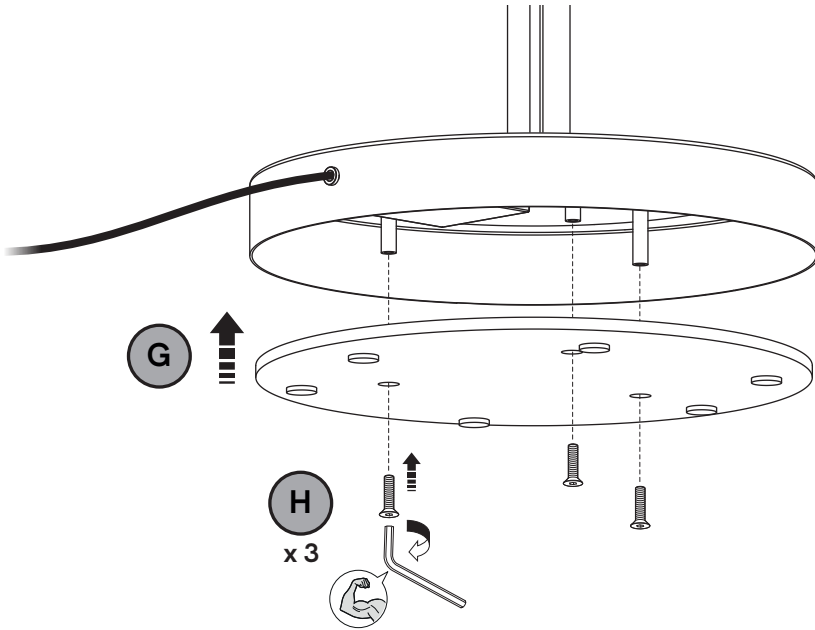

6

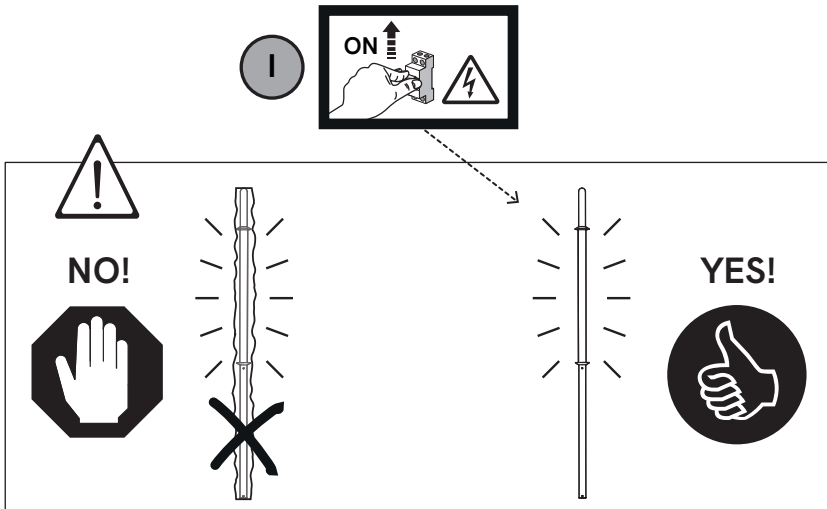

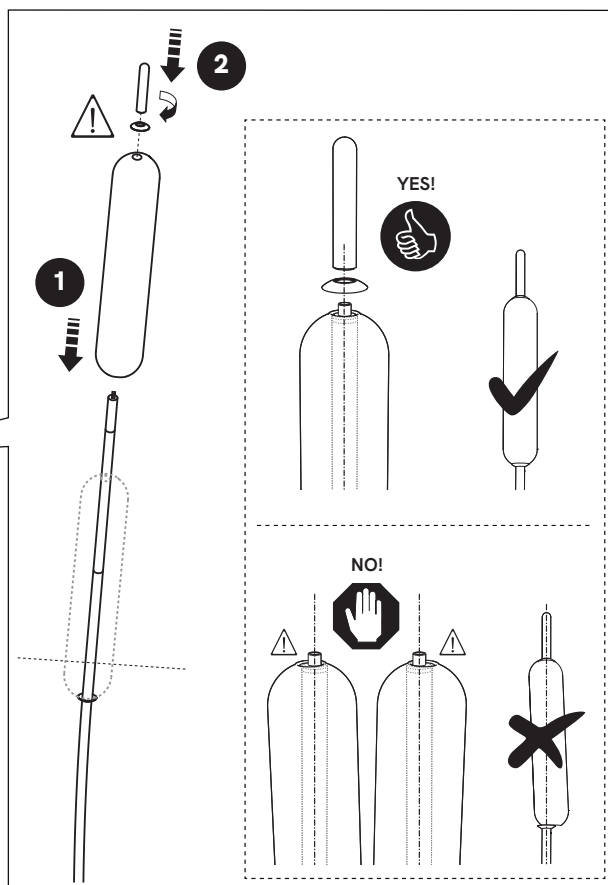
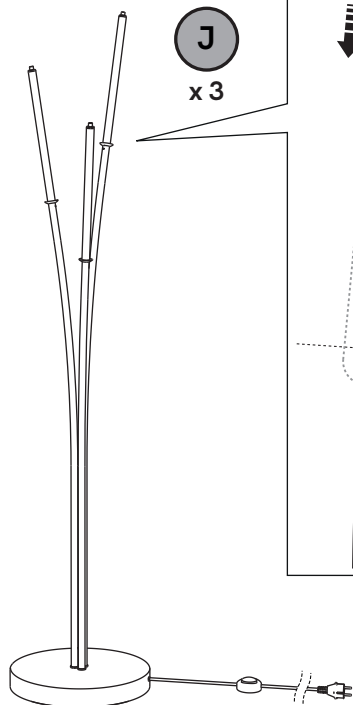

IT

**Accensione e spegnimento:** una pressione veloce sull'interruttore e rilascio.

**Regolazione luminosità (min. - max.):** per regolare il livello di luminosità è necessaria una pressione continua dell'interruttore e rilascio all'intensità raggiunta (inversione del senso di regolazione ad ogni rilascio e successiva pressione).

EN

**Turning on and off:** a quick press on the switch and release.

**Brightness adjustment (min. - max.):** to adjust the brightness level it is necessary to continuously press the switch and release it at the reached intensity (reversal of the direction of adjustment at each release and subsequent pressure).



# IL FANALE

---

**Il Fanale Group S.r.l.**

Via Olivo Bredariol, 15

31048 San Biagio di Callalta (TV) Italy

info@ilfanale.com

T +39 0422 895200

**ilfanale.com**