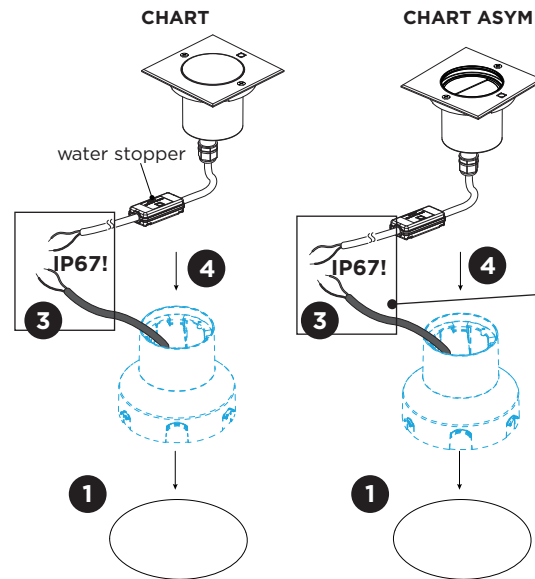

CHART 1.2/1.6 & CHART ASYM 1.2/1.6

INSTALLATION INSTRUCTIONS | NOVEMBER 2022

with ground housing



Do not cut off or open the water stopper on the cable.

Included:

waterproof connectors:



Optional:

IP68 connection box:

order ref. 73240706 = 2 WAYS 2x1,5 Ø6-8mm

Cut an opening in the ground housing to easier guide the cable sideways.

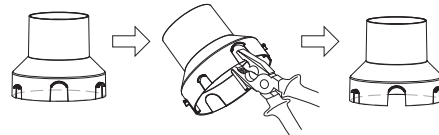

DIMENSIONS

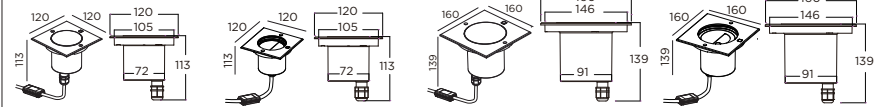

CHART 1.2

CHART ASYM 1.2

CHART 1.6

CHART ASYM 1.6

MOUNTING INSTRUCTION WITH GROUND HOUSING

- 1 Make a hole in the ground according to the prescribed dimensions (of the ground housing).
- 2 Drainage: we recommend that all exterior groundspots should be installed with a drainage level even when using a recessed housing.

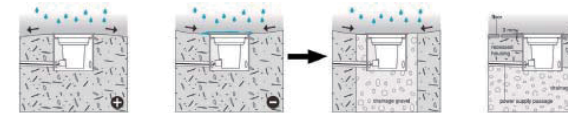

POWER CONNECTION

- 3 Connect to 220-240V.
- 4 Use screws to attach the fixture to the ground housing, screws are included.

optional ground housing

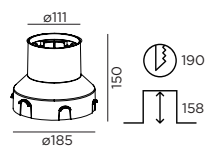

90012203
for CHART 1.2
for CHART ASYM 1.2

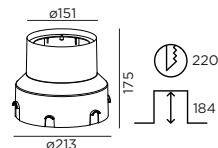

90012204
for CHART 1.6
for CHART ASYM 1.6

CHART 1.2/1.6 & CHART ASYM 1.2/1.6

INSTALLATION INSTRUCTIONS | NOVEMBER 2022

without ground housing

A. Attached to the floor (or wall, for wall mounting).

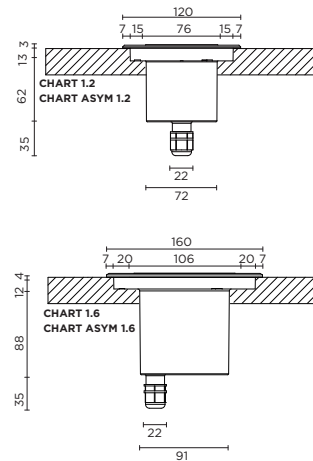
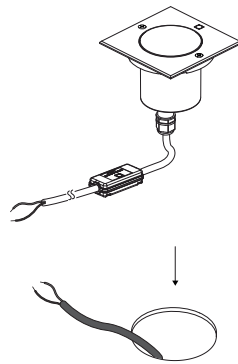

MOUNTING INSTRUCTION WITHOUT GROUND HOUSING

A. Attached to the floor (or wall, for wall mounting).

- 4** Use the screws (included) to attach the luminaire to the floor or wall. Make sure to measure correctly so that you can screw into a hard material.

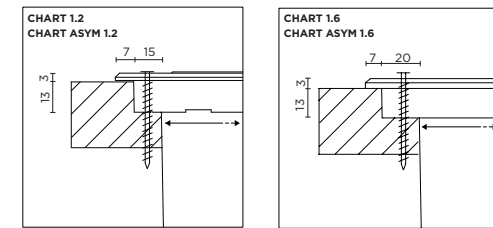

B. Rests on the stainless steel borders of the fixture.

- 4** Place the luminaire into the hole. No tool is needed to fix the luminaire as it will rest on the stainless steel frame.

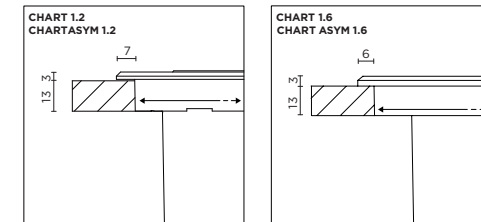

Note:
the bolts and
nuts can be used
for filling the
screwholes.

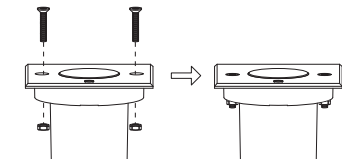

B. Rests on the stainless steel borders of the fixture.

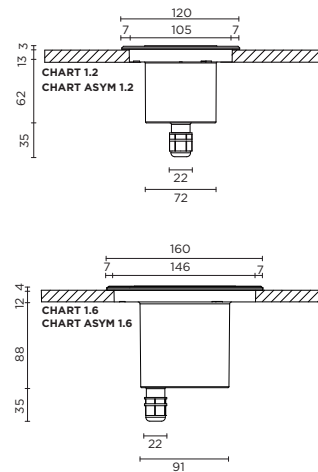
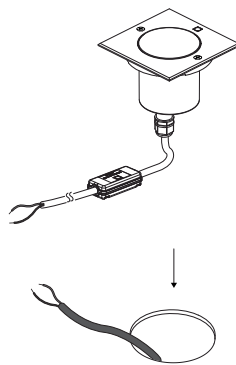
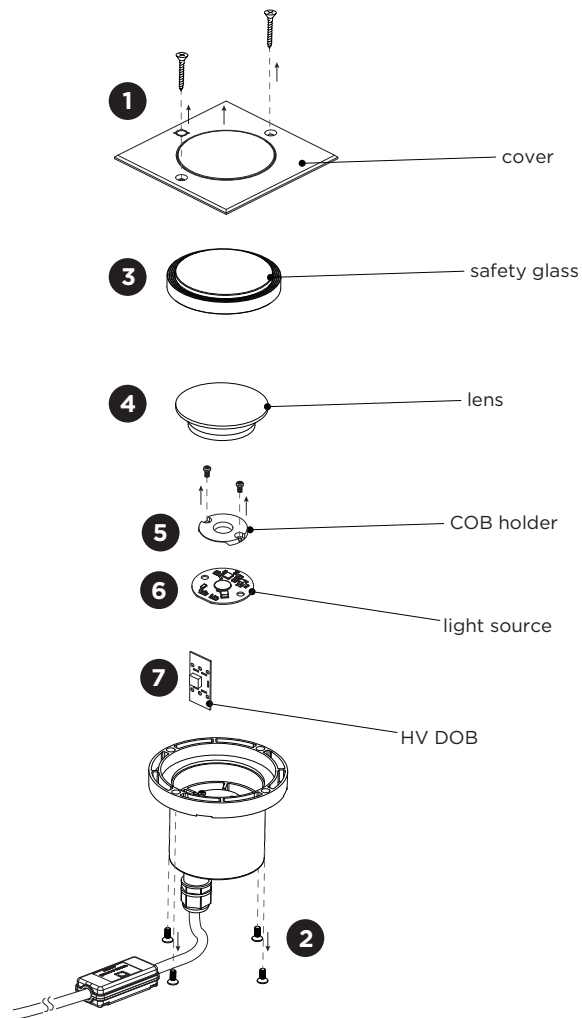

CHART 1.2/1.6 & CHART ASYM 1.2/1.6

INSTALLATION INSTRUCTIONS | NOVEMBER 2022



DISMOUNTING AND RECYCLING INSTRUCTIONS

Light source

- 1 Remove the screws and take out the fixture.
- 2 Remove the four screws below and remove the cover.
- 3 Remove the safety glass.
- 4 Remove the lens.
- 5 Remove the screws and the COB holder.
- 6 Disconnect the wires and remove the light source.
- 7 Remove the HV DOB.

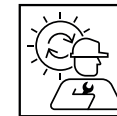

The light source is replaceable by an authorized professional.
For advice contact your Wever & Ducré customer service contact point.



This luminaire contains a light source with the energy class F.