

## INSTALLATION GUIDE

### *Alumina Lamp*

---

Thank you for making the switch to Tala.  
Discover the full Tala product family at [tala.co.uk](http://tala.co.uk)

---

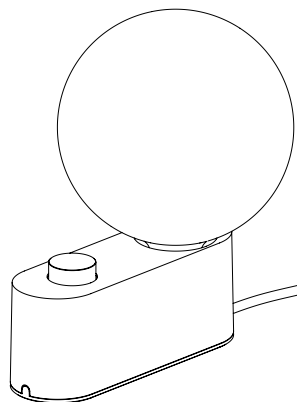

## BEFORE STARTING

Please read instructions thoroughly before installation and keep them for future reference. Please take extreme care when dealing with electrical equipment.

## IMPORTANT

Bulb must be installed in fixture before turning on.

## WARNING

Ensure power is turned OFF before inserting plug.

## CARE AND CLEANING

We recommend cleaning with a soft dry cloth. Do not use abrasive materials as these will damage the finish of the product.

## WARRANTY AND AFTER-CARE

This product has a three-year warranty. If there appears to be a functional defect with the product during this time, please contact our team at [customerservice@tala.co.uk](mailto:customerservice@tala.co.uk). The external flexible cable or cord of this luminaire cannot be replaced; if the cord is damaged, the luminaire shall be destroyed.

---

## Table Configuration

### STEP 1

Insert your bulb into the top of the lamp, rotating clockwise until tight. Take care not to tighten too much to avoid breakage.

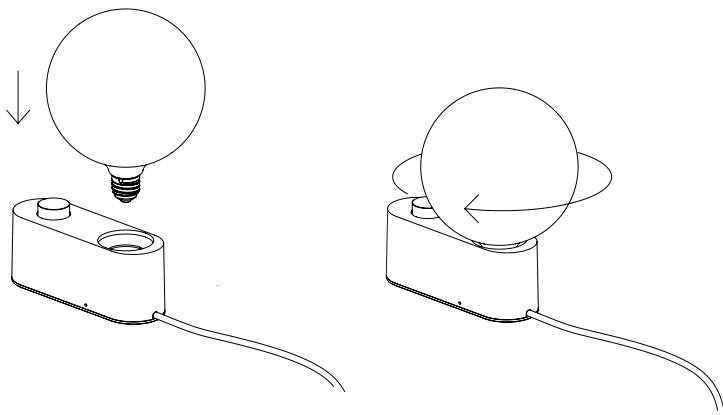

### STEP 2

Insert the lamp plug into your chosen wall socket, making sure the power is switched off.

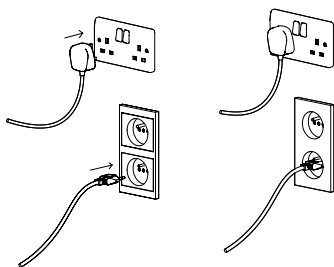

### STEP 3

Switch the power on and rotate the dial on your dimmer until the bulb lights up. Adjust the dimmer for your desired light output.

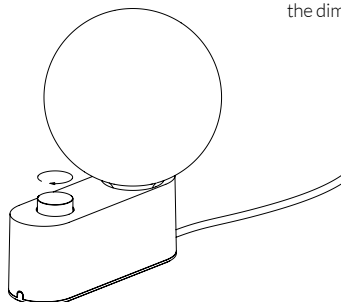

## Wall Configuration

### STEP 1

Remove your bulb from the lamp, rotating counter clockwise and set aside.

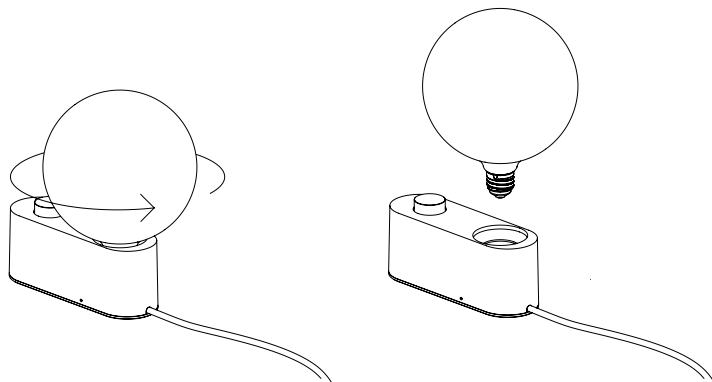

### STEP 2

Remove the small lock screw from the side of the lamp with the hex key provided.

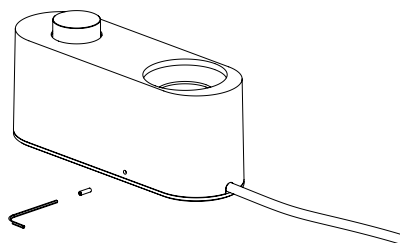

### STEP 3

Slide the lamp towards the cable to disconnect it from the base. Lift the lamp and set it aside.

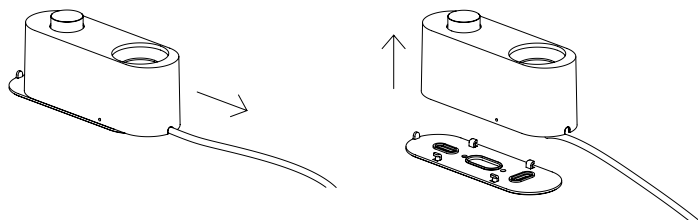

#### STEP 4

Attach the lamp base to the wall using the orientation displayed below. Always choose screws and plugs that are appropriate for the wall, and ensure the wall cavity is free from electrical cables or piping before commencing drilling.

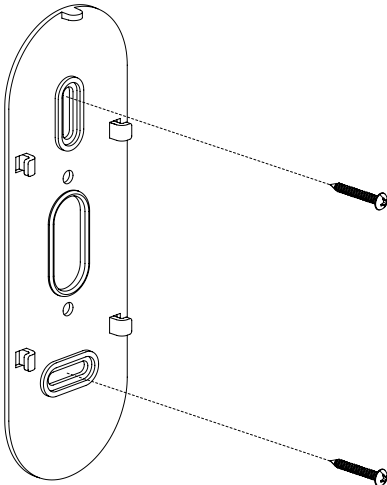

#### STEP 5 (OPTIONAL)

If you wish to hard wire the lamp into the household mains, please consult a qualified electrician before performing this modification. Note, junction boxes are not provided.

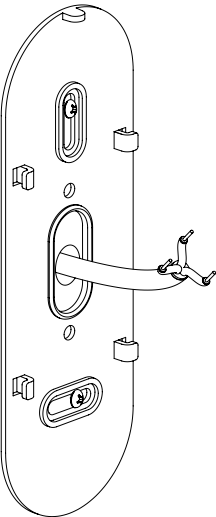

## STEP 6

Move the cable from the top to the bottom opening.

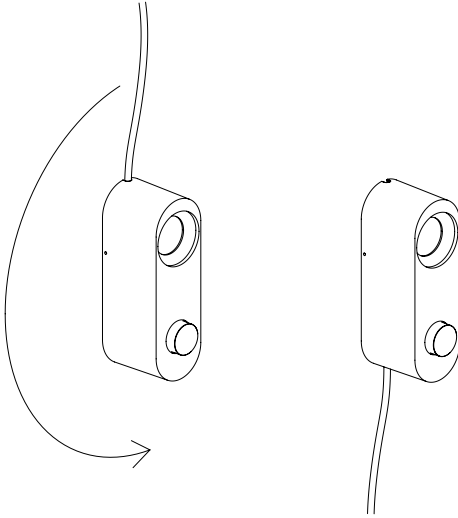

## STEP 7

Align the lamp above the base and slide down to lock in place.

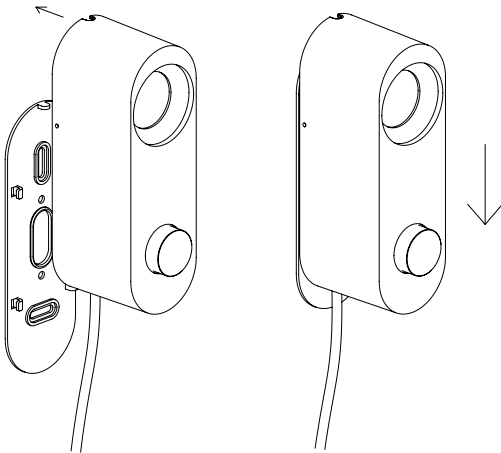

## STEP 8

Insert your bulb into the front of the lamp, rotating clockwise until tight. Take care not to tighten too much to avoid breakage.

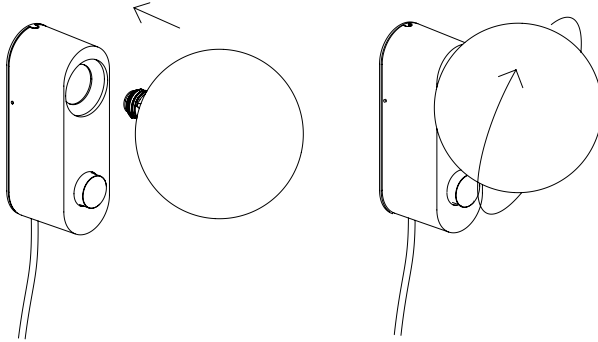

## STEP 9

Reattach the lock screw using the hex tool provided. Tighten until flush with the outside surface of the lamp. Over tightening may result in the screw becoming lost inside the lamp.

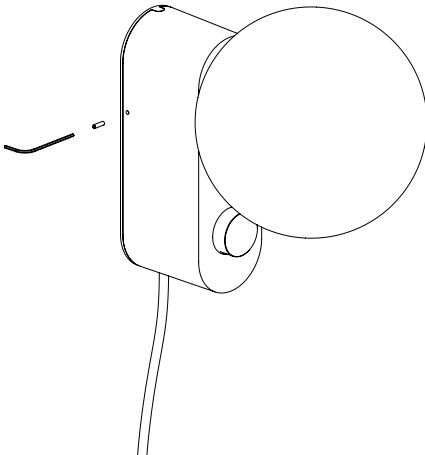

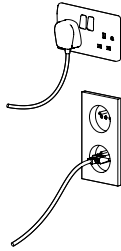
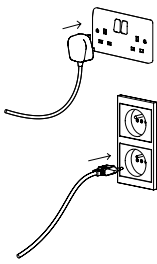

## STEP 10

Insert the lamp plug into your chosen wall socket, making sure the power is switched off.

## STEP 11

Switch the power on and rotate the dial on your dimmer until the bulb lights up. Adjust the dimmer for your desired light output.

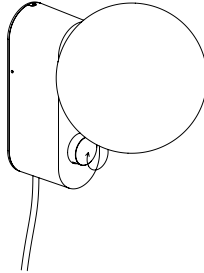

**Join the Community**

Instagram: @tala | Facebook: talaHQ | Pinterest: TalaLED | Tag: lighttoliveby  
Tala Studios, 25B Vyner Street, London E2 9DG | +44 20 3026 3246 | hello@tala.co.uk