

RF02178

Anodized aluminium rod for dimmer



WARNING! When installing and whenever acting on the appliance, ensure that the power supply has been switched off.
For the installation of the spare-part, it is necessary to consult a qualified electrician.

RF02178

Anodized aluminium rod for dimmer

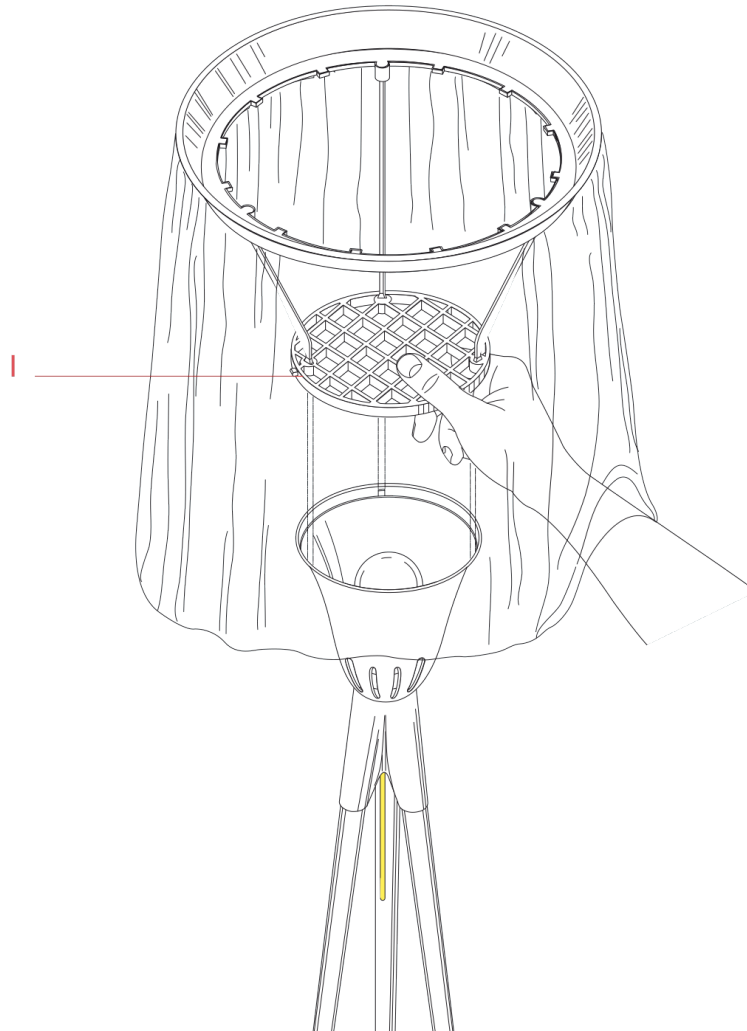

Fig.1

Remove the fabric diffuser and grid (I) from the lamp cup.

WARNING! When installing and whenever acting on the appliance, ensure that the power supply has been switched off.
For the installation of the spare-part, it is necessary to consult a qualified electrician.

RF02178

Anodized aluminium rod for dimmer

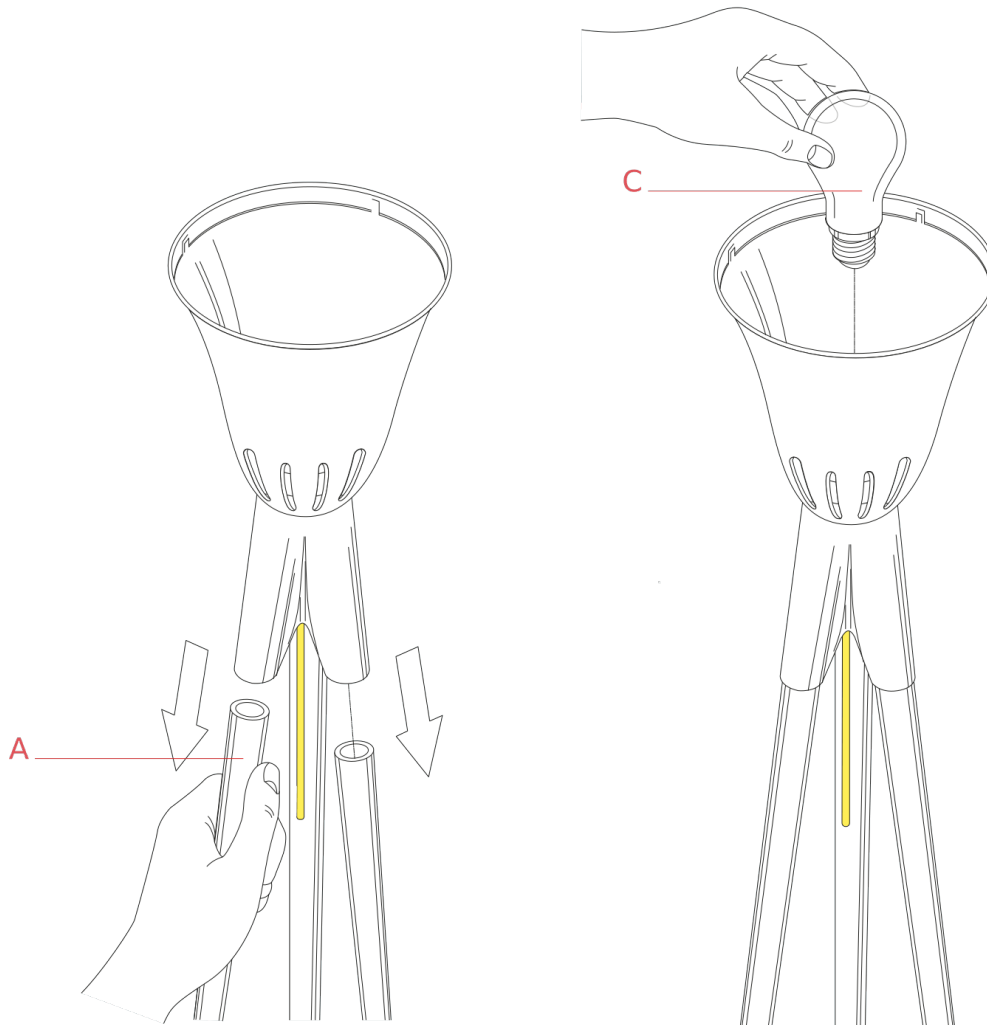

Fig.2

Detach the 2 lamp legs (A) from the lamp body (B).
Remove the bulb (C).

WARNING! When installing and whenever acting on the appliance, ensure that the power supply has been switched off.
For the installation of the spare-part, it is necessary to consult a qualified electrician.

RF02178

Anodized aluminium rod for dimmer

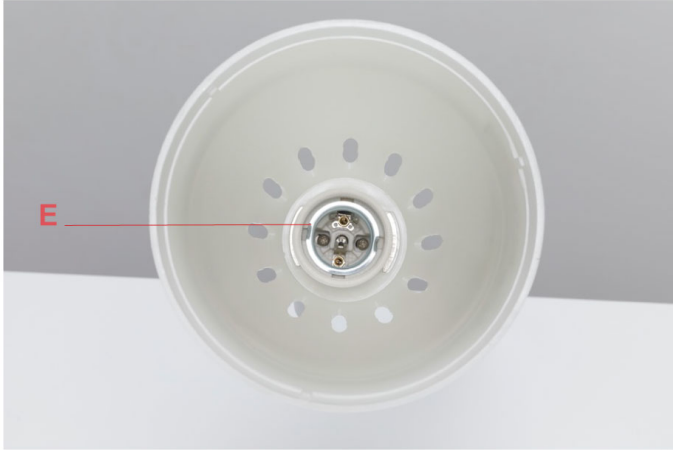

Fig.3

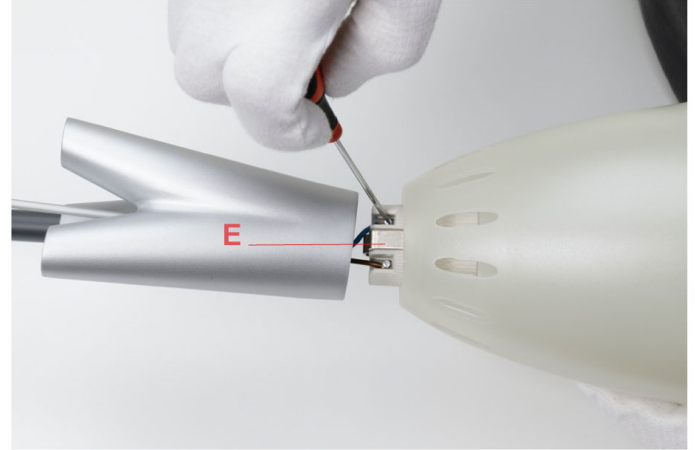

Fig.4

Unfasten the 2 screws (D) inside the lamp holder.
Disconnect the wires Blue (N) and Brown (L) from the lamp holder terminals (E) and remove the lamp holder through the lateral hooks from the lamp cup.

WARNING! When installing and whenever acting on the appliance, ensure that the power supply has been switched off.
For the installation of the spare-part, it is necessary to consult a qualified electrician.

RF02178

Anodized aluminium rod for dimmer

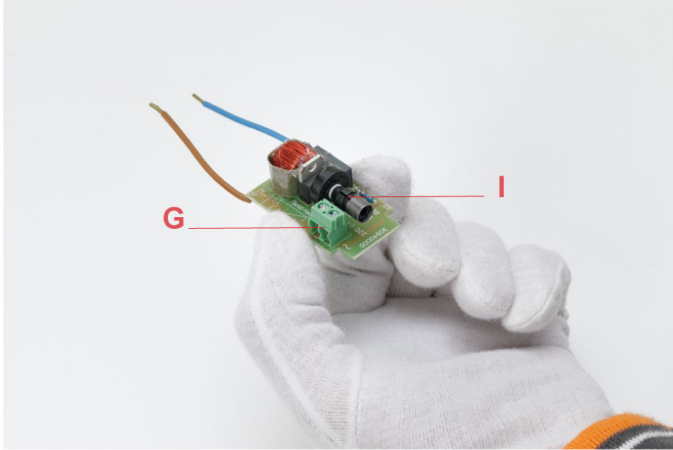

Fig.5

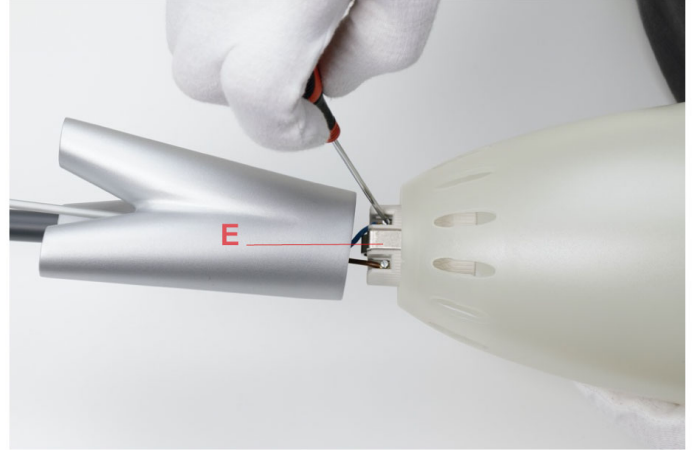

Fig.6

Pull-out the dimmer rod from the small drive shaft (I). Disconnect the electrical wires from the green terminal (G) and remove the PCB dimmer from the lamp body.

Assemble now the new spare-part: insert inside the lamp body the dimmer.

Insert the rod inside the small drive shaft (I).

Connect the electrical wires to the green terminals (G).

WARNING! When installing and whenever acting on the appliance, ensure that the power supply has been switched off.
For the installation of the spare-part, it is necessary to consult a qualified electrician.

RF02178

Anodized aluminium rod for dimmer

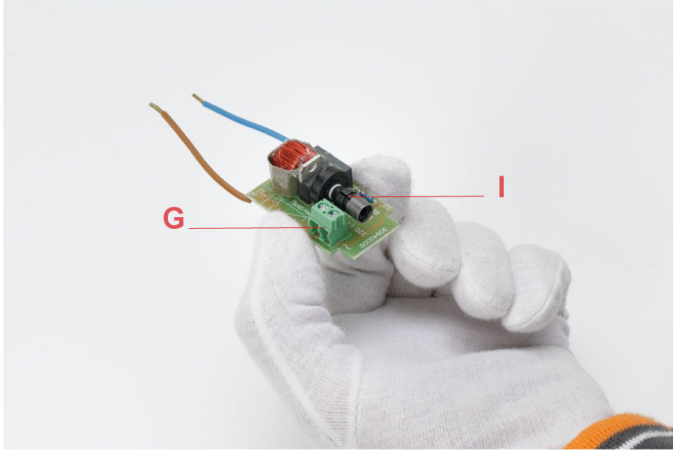

Fig.7



Fig.8

Pull-out the dimmer rod from the small drive shaft (I). Disconnect the electrical wires from the green terminal (G) and remove the PCB dimmer from the lamp body.

Assemble now the new spare-part: insert inside the lamp body the dimmer.

Insert the rod inside the small drive shaft (I).

Connect the electrical wires to the green terminals (G).

Install the lamp holder (J) to the new lamp cup (K).

WARNING! When installing and whenever acting on the appliance, ensure that the power supply has been switched off.
For the installation of the spare-part, it is necessary to consult a qualified electrician.

RF02178

Anodized aluminium rod for dimmer

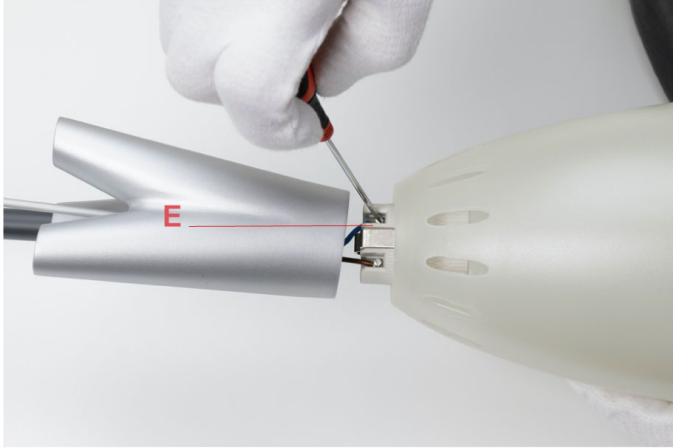

Fig.9



Fig.10

Connect the dimmer wires (Blue and Brown) to the lamp holder terminals (E) by respecting the polarities.
Assemble back the lamp holder and cup to the lamp body by fastening the 2 screws.

WARNING! When installing and whenever acting on the appliance, ensure that the power supply has been switched off.
For the installation of the spare-part, it is necessary to consult a qualified electrician.

©2021 Flos - All rights reserved - www.flos.com
Flos reserves the right to introduce any changes to its own models, without prior notice.

RF02178

Anodized aluminium rod for dimmer

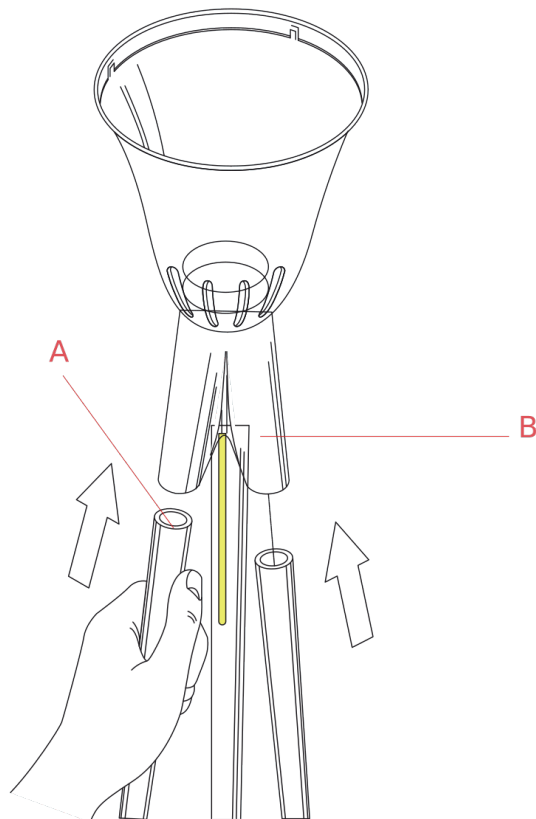

Fig.11

Insert the legs (A) in the body lamp (B).

WARNING! When installing and whenever acting on the appliance, ensure that the power supply has been switched off.
For the installation of the spare-part, it is necessary to consult a qualified electrician.

RF02178

Anodized aluminium rod for dimmer

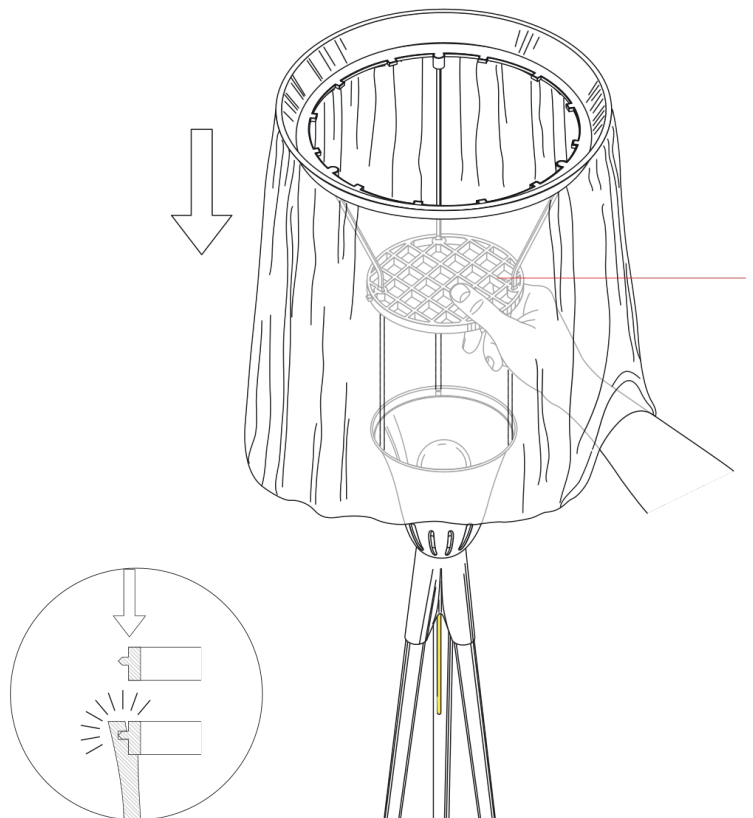

Fig.12

Insert the ring nut (I) and the fabric sheet (D) in the plastic diffuser housings (L) until they click into place as indicated in the figure.

REMARKS! For a correct installation, align the three supports with the plastic internal diffuser.

WARNING! When installing and whenever acting on the appliance, ensure that the power supply has been switched off. For the installation of the spare-part, it is necessary to consult a qualified electrician.