

General use

- The product is designed for indoor and outdoor use*.
* Please note that copper and brass with Lacquered surface are only for indoor use.
- The lamp gets hot after prolonged use, therefore, do not cover the product.
- The surface of raw copper and brass will patinate over time.

Cleaning instructions

- Wipe surface of lamp shade with a soft cloth.
- Do not use any abrasive cleaning tools such as steel wool, scouring sponges or stiff brushes.
- Never use strong cleaning agents such as white spirit, household glass cleaner or cellulose thinners.
- Finish cleaning of stainless steel surface with acid free oil to prevent rust-like tarnishes.

Safety precautions

- Dispose of plastic bag from packaging and do not allow children to play with it.
- Consult a qualified electrician if in any doubt.

Certificates and approvals

LIGHT-POINT declares that this product is in compliance with essential requirements and relevant provisions:

 Declaration of Conformity.
Contact LIGHT-POINT for more information.

 The product conforms with Class II or double insulated electrical appliance, that has been designed in such a way that it does not require a safety connection to electrical earth (ground).

Certificates and approvals

Continued...



Electrical and electronic equipment (WEEE) contains materials, components and substances that may be dangerous and hazardous to human health and to the environment when waste from electrical and electronic equipment is not disposed of correctly.

IP23

Protected from water spray less than 60 degrees from vertical.



RØRHAT Wall is available in 3 versions:
- G23 Bulb
- E14 Bulb
- LED 10,5W

International warranty

Your product has gone through rigorous testing in order to live up to the highest quality standards. It therefore carries a 7-year warranty in Europe from the date of the original retail purchase receipt, covering defects in materials and workmanship when used normally in accordance with the published LIGHT-POINT guid elines.

These guidelines include but are not limited to information contained in technical speci cations, safety instructions and quick start guides. LIGHT-POINT is not responsible for damage arising from failure to follow instructions relating to the use of the product.

LIGHT-POINT is a registered trademark of NORDIC LIVING GROUP.

For more information, please visit LIGHT-POINT.COM



RØRHAT
H A N D C R A F T E D

User Instructions
RØRHAT Wall

1

Before installation, make sure the power supply is switched off

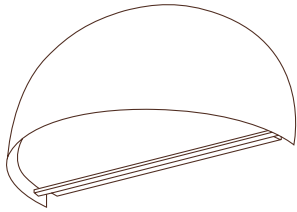
The lamp comes assembled and has to be disassembled before mounting



2

Remove the acrylic cover

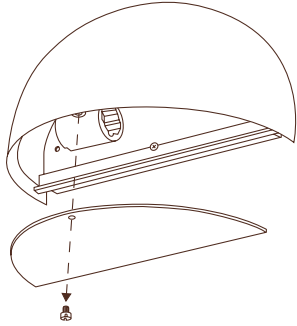

3

Remove the lamp shade

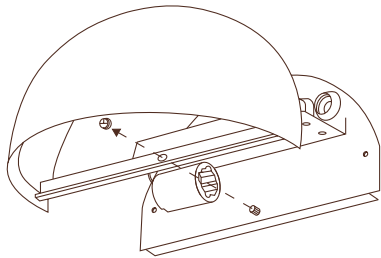

4

Use the lamp base as a template to mark the position of the holes on the wall

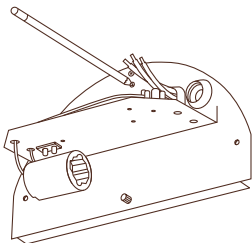

5

Drill the three holes

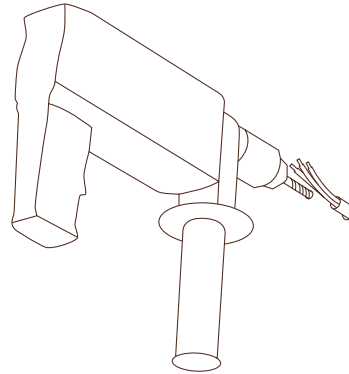

6

Mount the lamp base and connect the power supply

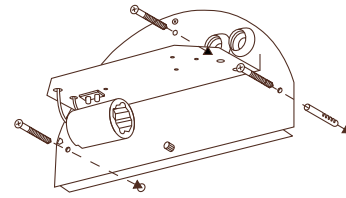

7

Mount the lamp shade

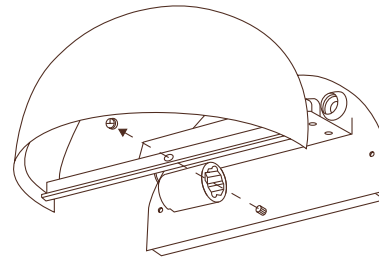

8

Install the light bulb and acrylic cover

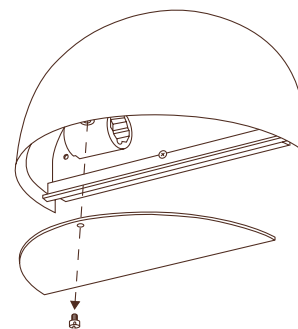

9

Finished

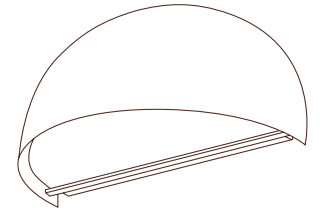

Base measurement drawing

Front

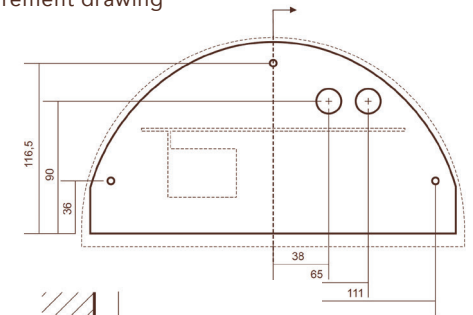

Section

