

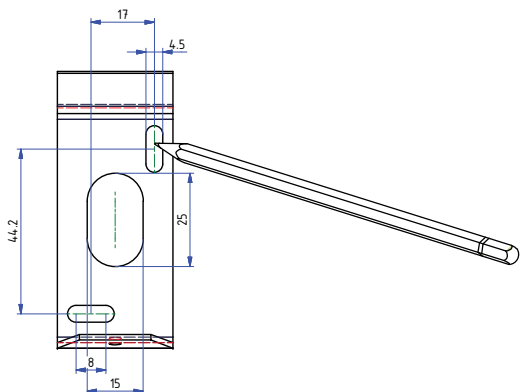

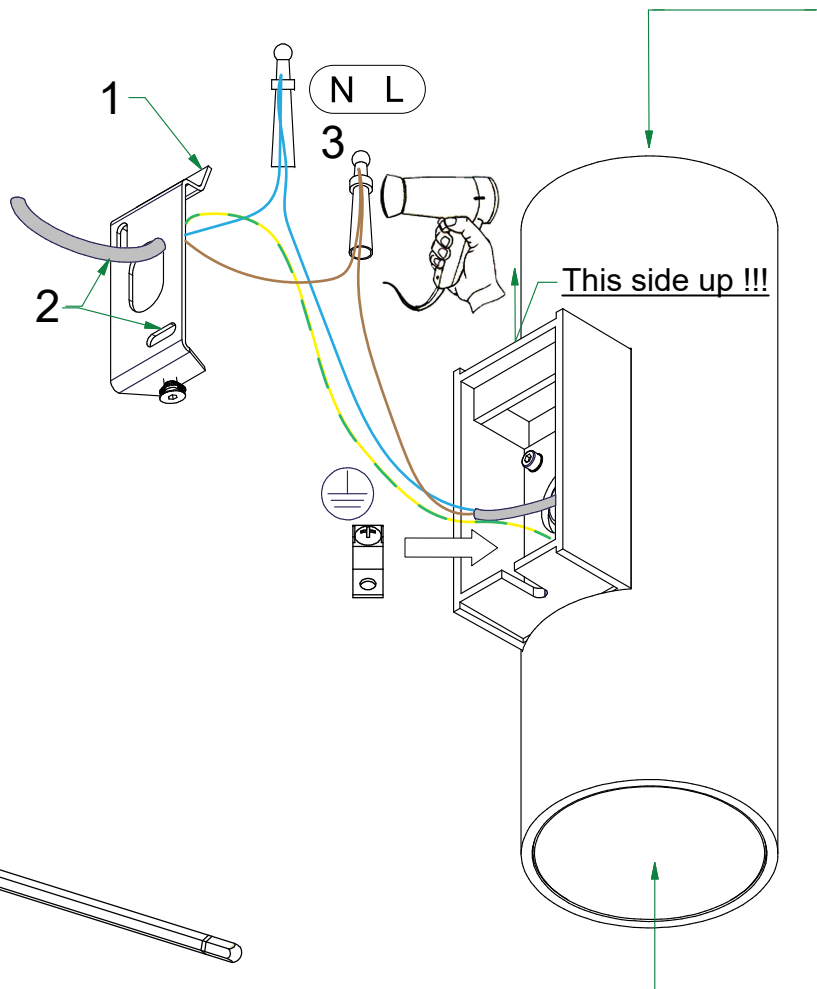

# NudeWall IP 2xLED 3KF





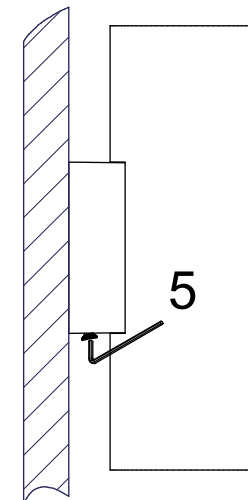
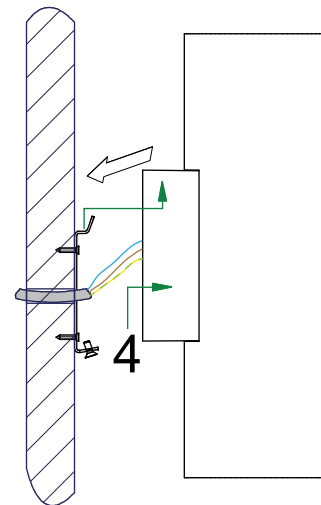



109231XX



 Replace protective shields when broken  
The luminaire shall only be used complete with its protective shields (reference number 1009285)



 The light source contained in this luminaire shall only be replaced by the manufacturer or his service agent or a similar qualified person

	220-230V 50-60Hz							
---	---------------------	---	---	---	---	---	---	---