

TAB LED F

Designed by E. Barber and J. Osgerby, 2011

F6564031

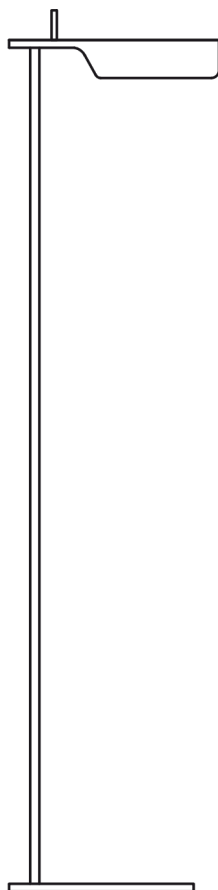

TAB LED F

F6564031

IT

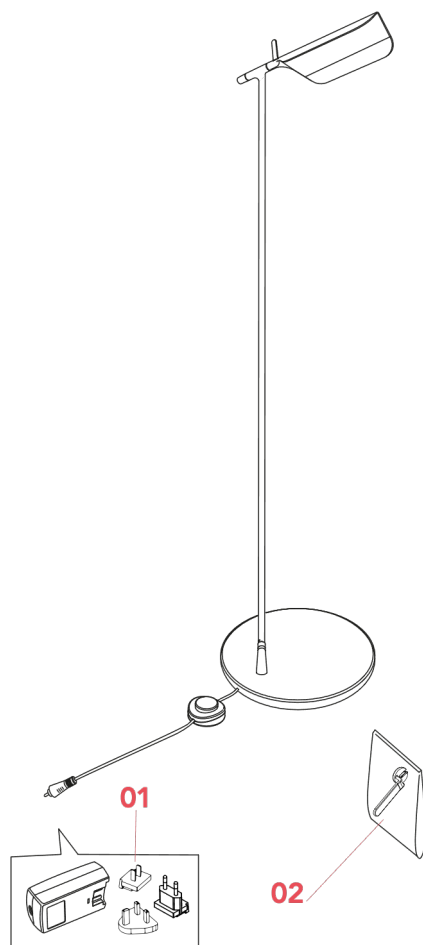

01. RF3320100 – Black Plug kit + driver spare part

02. RF13905 – Locking key tool

TAB LED F F6564031

EN

RF3320100

PLUG KIT + DRIVER SPARE PART

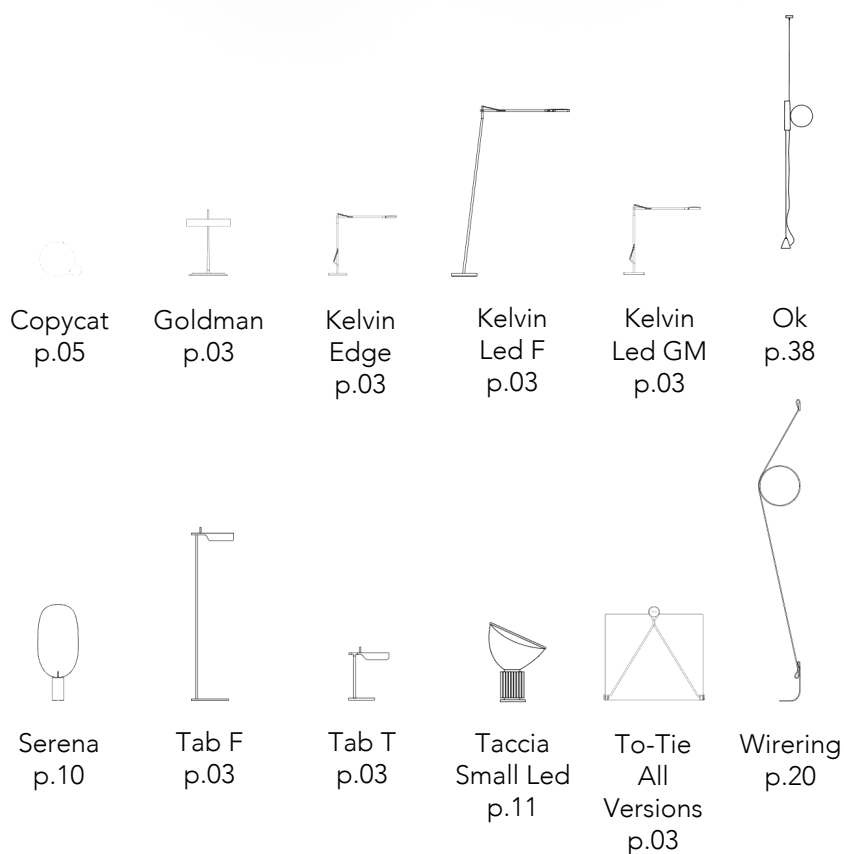

WARNING! When installing and whenever acting on the appliance, ensure that the power supply has been switched off. For the installation of the spare-part, it is necessary to consult a qualified electrician.

TAB LED F F6564031

EN

RF3320100

PLUG KIT + DRIVER SPARE PART

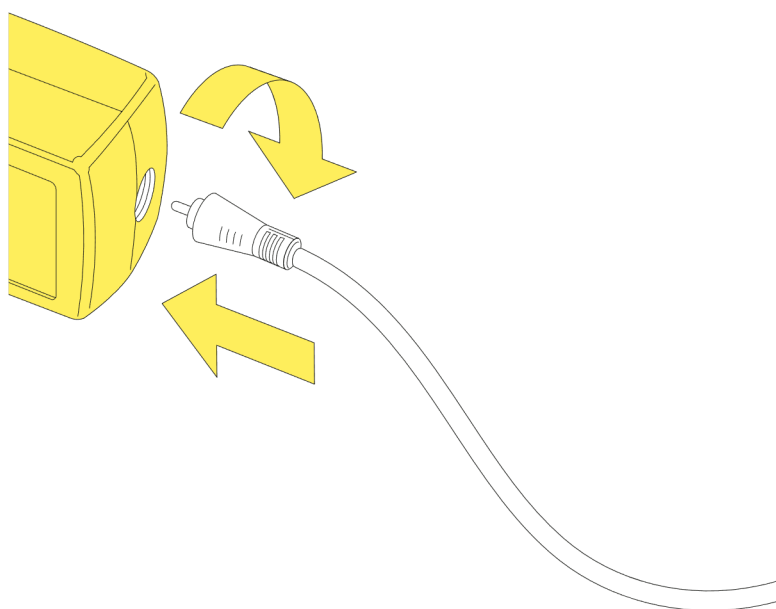

Fig.1

Insert the plug into the driver unit by using the guides snap it inside its apposite slot (use the correct type of plug for area in which the device must be installed), connect the plug to the feeder unit locking it in by rotating it 90° clockwise.

WARNING! When installing and whenever acting on the appliance, ensure that the power supply has been switched off. For the installation of the spare-part, it is necessary to consult a qualified electrician.

TAB LED F F6564031

EN

RF13905

LOCKING KEY TOOL



Bedside
Gun
p.15

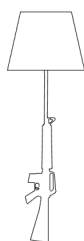

Lounge
Gun
p.17



Tab led
F
p.05

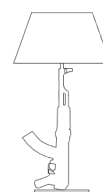

Table
Gun
p.15

WARNING! When installing and whenever acting on the appliance, ensure that the power supply has been switched off. For the installation of the spare-part, it is necessary to consult a qualified electrician.

TAB LED F F6564031

EN

RF13905

LOCKING KEY TOOL

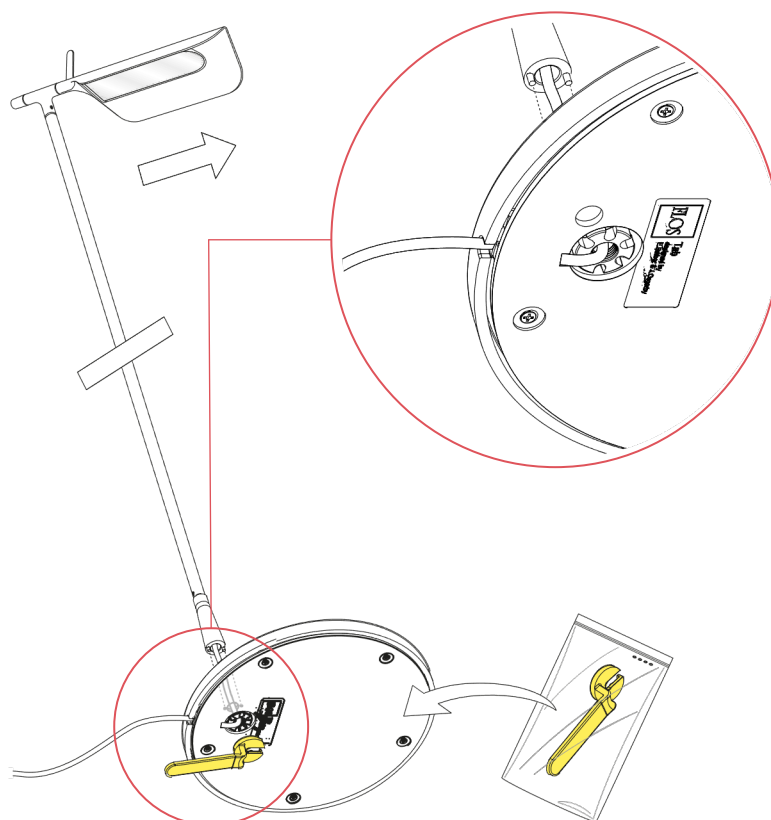

Fig.1

Fasten the screw (A) by utilizing the key (B).

WARNING! When installing and whenever acting on the appliance, ensure that the power supply has been switched off. For the installation of the spare-part, it is necessary to consult a qualified electrician.