

## IC F2

Designed by Michael Anastassiades, 2014

F3174057

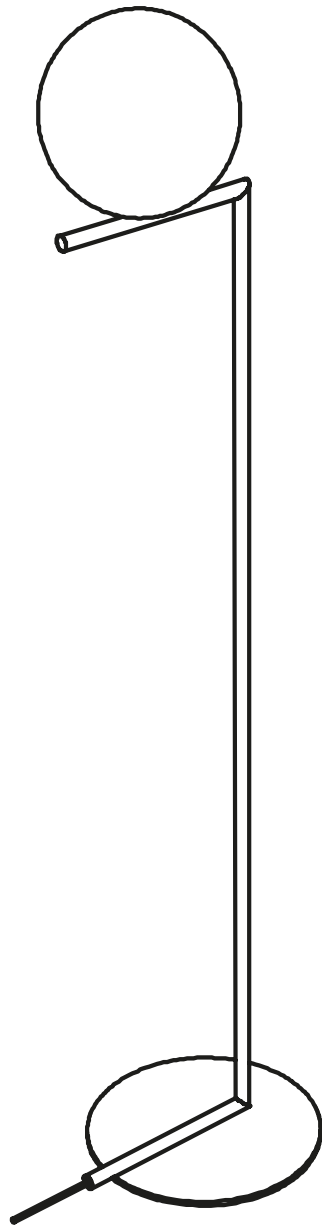

## IC F2

F3174057

EN

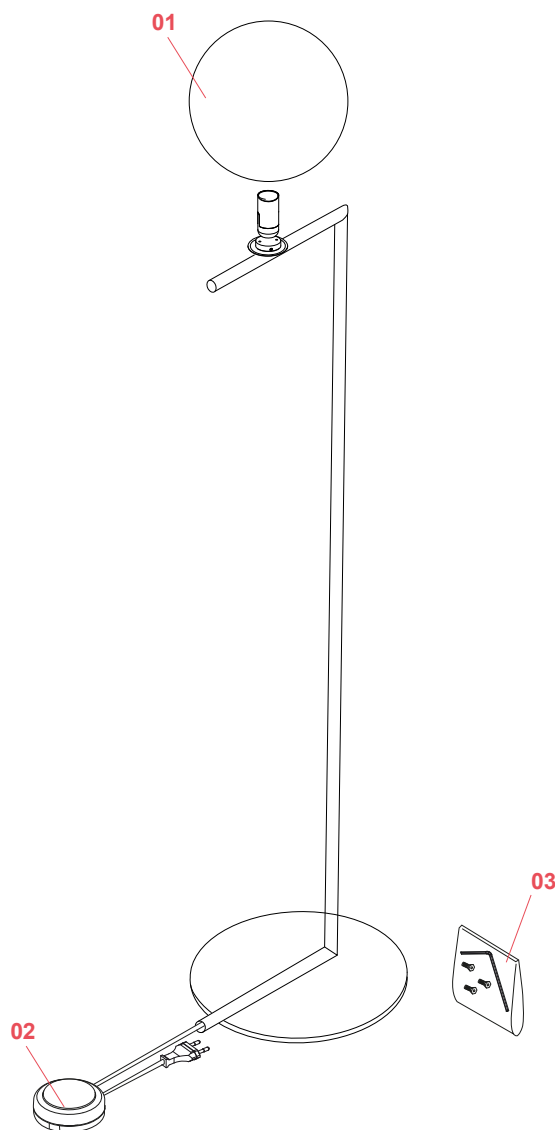

**01. F3137057** – Glass diffuser 2 assembly for chrome version

**02. RF28045** – LED 220-240V Rondò dimmer

**03. RF3130100** – Screw kit with Allen key for base assembly

IC F2 F3174057

EN

## F3137057

GLASS DIFFUSER 2 ASSEMBLY FOR CHROME VERSION



Ic-CW2  
p.03

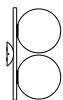

Ic-CW2  
double  
p.03



Ic-F2  
p.03



Ic-S2  
p.03



Ic T2  
p.03

WARNING! When installing and whenever acting on the appliance, ensure that the power supply has been switched off.  
For the installation of the spare-part, it is necessary to consult a qualified electrician.

IC F2 F3174057

EN

**F3137057**

GLASS DIFFUSER 2 ASSEMBLY FOR CHROME VERSION

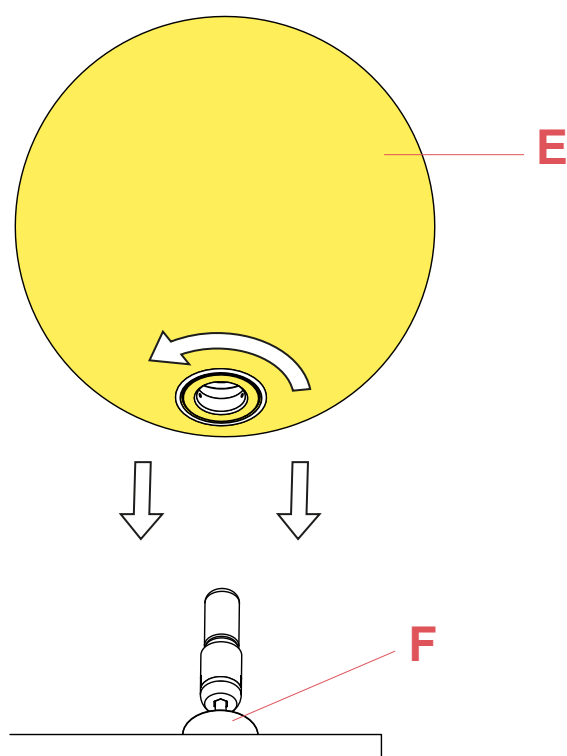

Fig.1

Assemble the glass diffuser (E) by fastening it delicately to the lamp body's ferrule (F).

WARNING! When installing and whenever acting on the appliance, ensure that the power supply has been switched off.  
For the installation of the spare-part, it is necessary to consult a qualified electrician.

IC F2 F3174057

EN

## RF28045

LED RONDÒ DIMMER 220-240V 40-250W 4-100W

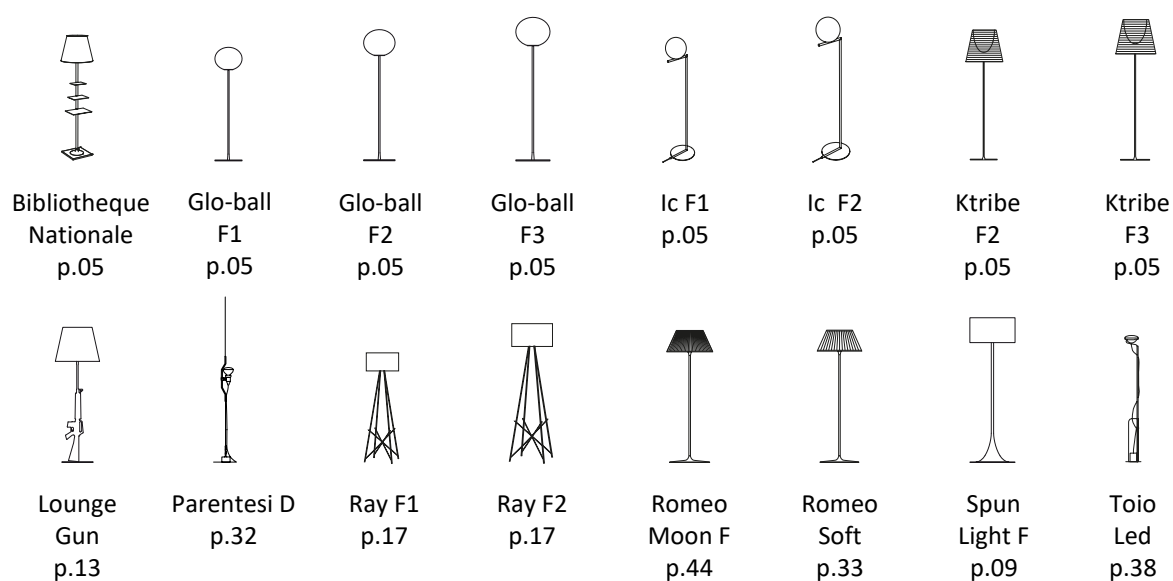

WARNING! When installing and whenever acting on the appliance, ensure that the power supply has been switched off.  
For the installation of the spare-part, it is necessary to consult a qualified electrician.

IC F2 F3174057

EN

## RF28045

LED RONDÒ DIMMER 220-240V 40-250W 4-100W



Fig.1

Open the box of the damaged dimmer.  
For the opening, it is necessary to remove the rubber pad from underneath the dimmer box;



Fig.2

Unfasten the screw that locks the triangle terminal cover.

**WARNING!** When installing and whenever acting on the appliance, ensure that the power supply has been switched off.  
For the installation of the spare-part, it is necessary to consult a qualified electrician.

IC F2 F3174057

EN

## RF28045

LED RONDÒ DIMMER 220-240V 40-250W 4-100W



Fig.3

Turn the dimmer box and remove the terminal cover;



Fig.4

Unfasten the three screws of the cable clamps;

**WARNING!** When installing and whenever acting on the appliance, ensure that the power supply has been switched off. For the installation of the spare-part, it is necessary to consult a qualified electrician.

IC F2 F3174057

EN

## RF28045

LED RONDÒ DIMMER 220-240V 40-250W 4-100W



Fig.5

Remove the cable clamp and disconnect the cables from the green terminal box.



Fig.6

Assemble now the new dimmer:  
Connect the cables respecting the polarities, lock the wires by positioning the cable clamp and then fasten the three screws, cover the green terminal box with the triangle cover, turn the dimmer box, fasten the screw and stick-on the rubber pads.

**WARNING!** When installing and whenever acting on the appliance, ensure that the power supply has been switched off.  
For the installation of the spare-part, it is necessary to consult a qualified electrician.



IC F2 F3174057

EN

## RF3130100

SCREW KIT WITH ALLEN KEY FOR BASE ASSEMBLY

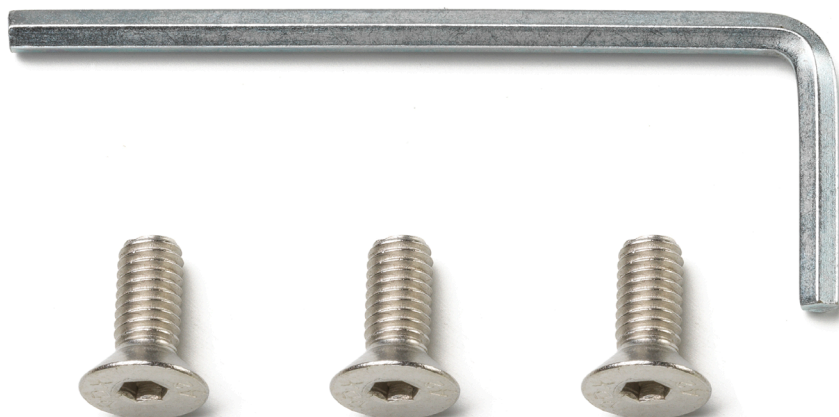

Ic F1  
p.09



Ic F2  
p.09

WARNING! When installing and whenever acting on the appliance, ensure that the power supply has been switched off.  
For the installation of the spare-part, it is necessary to consult a qualified electrician.

IC F2 F3174057

EN

**RF3130100**

SCREW KIT WITH ALLEN KEY FOR BASE ASSEMBLY

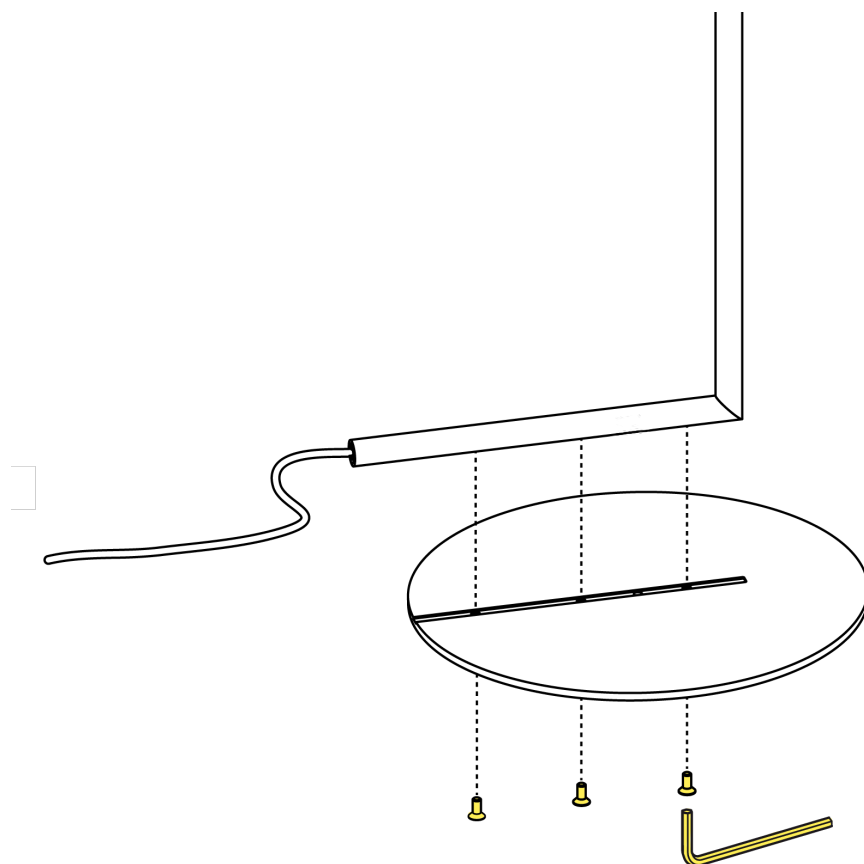

Fig.1

Assemble the base (C) onto the lamp body (B) by fastening the 3 screws (D) with the Allen key supplied with the kit.

WARNING! When installing and whenever acting on the appliance, ensure that the power supply has been switched off.  
For the installation of the spare-part, it is necessary to consult a qualified electrician.

©2021 Flos - All rights reserved - [www.flos.com](http://www.flos.com)  
Flos reserves the right to introduce any changes to its own models, without prior notice.