



WEVER & DUCRÉ
LIGHTING

SQUBE on track 3.0 LED

144558W3

Project

Type

Notities

Kwantiteit

Datum

ALGEMEEN

Plafond, Track

Max. kantelhoek 90°

Rotatie 355°

Mat wit

RAL 9003^a

IP20

Interieur

Output: 1400 lm

CIE flux code: 95 99 100 100 100

LED

2700 K

CRI ≥ 90

L70 / 55000h

3 SDCM

OPTISCH

Medium, Stralingshoek 27°

ELEKTRISCH

phase-cut dim

220 - 240 V

Totaal aangesloten vermogen 14.6 W

Klasse 1

FYSISCH

Diameter 80 mm

Hoogte 110 mm

0.75 kg

70 (adapter) mm

incl. adapter 3-fase track

^a De kleur kan vanwege productieomstandigheden iets afwijken.



Spot voor van gegoten aluminium incl. adapter 3-fase track; oppervlak Mat wit; gepoedercoat; mat textuur; RAL 9003; binnenring zwart; met COB (Chip on Board) technologie voor maximale efficiëntie; phase-cut dim; lichtkleur 2700 K; binning initial MacAdam ≤ 3 SDCM; CRI ≥ 90; 220 - 240 V; stralingshoek 27°; spotkop 355° draaibaar en 90° kantelbaar; beschermingsgraad IP20; Klasse 1; lichtbron vervangbaar door gekwalificeerd personeel;

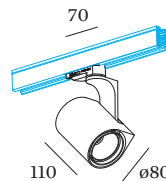

LICHTVERDELING

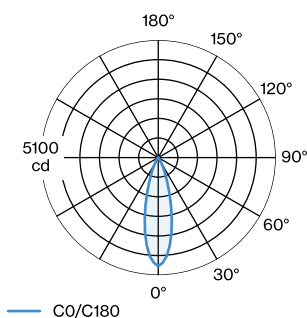



WEVER & DUCRÉ
LIGHTING

SQUBE

on track 3.0 LED

144558W3

KEGELDIAGRAM

medium 28°

h (m)	EO° (lx)	ø (m)
1	4720	0.50
2	1180	1.00
3	520	1.50
4	290	2.00
5	190	2.50

Onderhoudsfactoren

Bedrijfstijd [h]	10 000	20 000	30 000	40 000	50 000
LLMF	0.95	0.91	0.86	0.82	0.79
LSF	1	1	1	1	1

MF	LMF × RSMF × LLMF × LSF	RSMF ^a	Onderhoudsfactor ruimte
MF	Onderhoudsfactor	LLMF	Lumenbehoudfactor lichtbron
LMF ^a	Behoudfactor armatuur	LSF	Overlevingsfactor lichtbron

^a Volgens "CIE 97, Maintenance of indoor electric lighting systems", 2005, ISBN 3-900-734-34-8. De waarden moeten bepaald worden door de planningverantwoordelijke.

ELEKTRISCH

Dimmer

TYPE	KLEUR	L · W · H (MM)	ORDERCODE
voor schakelaar		46-17.5-46	9 0 0 1 9 0 1 7
DIN RAIL	Wit	17-55-90	9 0 0 1 9 0 1 8

Snijgereedschap

TYPE	ORDERCODE
3-fase track en 48V track	9 0 0 1 4 1 6 5

L-Connector 1.0

TYPE	KLEUR	L · W · H (MM)	ORDERCODE
3-fase track links	Wit	143-140-38	9 0 0 1 4 2 2 0
3-fase track links	Zwart	143-140-38	9 0 0 1 4 2 2 1

L-Connector 2.0

TYPE	KLEUR	L · W · H (MM)	ORDERCODE
3-fase track rechts	Wit	143-140-38	9 0 0 1 4 2 2 2
3-fase track rechts	Zwart	143-140-38	9 0 0 1 4 2 2 3

Voeding midden

TYPE	KLEUR	L · H (MM)	ORDERCODE
3-fase track rechtdoor	Wit	253-38	9 0 0 1 4 2 2 4
3-fase track rechtdoor	Zwart	253-38	9 0 0 1 4 2 2 5



WEVER & DUCRÉ
LIGHTING

SQUBE on track 3.0 LED

144558W3

Rechte connector

TYPE	KLEUR	L · W · H (MM)	ORDERCODE
3-fase track rechtdoor	Wit	115-25-33	9 0 0 1 4 2 2 6
3-fase track rechtdoor	Zwart	115-25-33	9 0 0 1 4 2 2 7

T-Connector 1.0

TYPE	KLEUR	L · W · H (MM)	ORDERCODE
3-fase track	Wit	254-143-38	9 0 0 1 4 2 2 8
3-fase track	Zwart	254-143-38	9 0 0 1 4 2 2 9

T-Connector 2.0

TYPE	KLEUR	L · W · H (MM)	ORDERCODE
3-fase track	Wit	254-143-38	9 0 0 1 4 2 3 0
3-fase track	Zwart	254-143-38	9 0 0 1 4 2 3 1

T-Connector 3.0

TYPE	KLEUR	L · W · H (MM)	ORDERCODE
3-fase track	Wit	254-143-38	9 0 0 1 4 2 3 2
3-fase track	Zwart	254-143-38	9 0 0 1 4 2 3 3

T-Connector 4.0

TYPE	KLEUR	L · W · H (MM)	ORDERCODE
3-fase track	Wit	254-143-38	9 0 0 1 4 2 3 4
3-fase track	Zwart	254-143-38	9 0 0 1 4 2 3 5

Eindvoeding | links

TYPE	KLEUR	L · W · H (MM)	ORDERCODE
3-fase track	Wit	148-32-38	9 0 0 1 4 2 3 8
3-fase track	Zwart	148-32-38	9 0 0 1 4 2 3 9

Eindvoeding | rechts

TYPE	KLEUR	L · W · H (MM)	ORDERCODE
3-fase track	Wit	148-32-38	9 0 0 1 4 2 4 0
3-fase track	Zwart	148-32-38	9 0 0 1 4 2 4 1

X-voeding

TYPE	KLEUR	L · W · H (MM)	ORDERCODE
3-fase track	Wit	254-254-38	9 0 0 1 4 2 4 8
3-fase track	Zwart	254-254-38	9 0 0 1 4 2 4 9

OPBOUW

Trackprofiel 1m

TYPE	KLEUR	L · W · H (MM)	ORDERCODE
3-fase track opbouw/pendel	Wit	1000-32-38	9 0 0 1 4 2 0 0
3-fase track opbouw/pendel	Zwart	1000-32-38	9 0 0 1 4 2 0 1



WEVER & DUCRÉ
LIGHTING

SQUBE on track 3.0 LED

144558W3

Trackprofiel 2m

TYPE	KLEUR	L · W · H (MM)	ORDERCODE
3-fase track opbouw/pendel	Wit	2000-32-38	9 0 0 1 4 2 0 2
3-fase track opbouw/pendel	Zwart	2000-32-38	9 0 0 1 4 2 0 3

Trackprofiel 3m

TYPE	KLEUR	L · W · H (MM)	ORDERCODE
3-fase track opbouw/pendel	Wit	3000-32-38	9 0 0 1 4 2 0 4
3-fase track opbouw/pendel	Zwart	3000-32-38	9 0 0 1 4 2 0 5

Flexibele connector

TYPE	KLEUR	L · W · H (MM)	ORDERCODE
3-fase track	Wit	143-143-38	9 0 0 1 4 2 8 8
3-fase track	Zwart	143-38-31	9 0 0 1 4 2 8 9

PENDEL

Ophangset 1.5m

TYPE	KLEUR	Ø · H (MM)	ORDERCODE
3-fase track pendel	Wit	∅32-1500	9 0 0 1 4 2 0 6
3-fase track pendel	Zwart	∅32-1500	9 0 0 1 4 2 0 7

Ophangset 3.0m

TYPE	KLEUR	Ø · H (MM)	ORDERCODE
3-fase track pendel	Wit	∅32-3000	9 0 0 1 4 2 0 8
3-fase track pendel	Zwart	∅32-3000	9 0 0 1 4 2 0 9

Trackadapter

TYPE	KLEUR	ORDERCODE
3-fase track	Wit	9 0 0 1 4 2 7 9
3-fase track	Zwart	9 0 0 1 4 2 8 0

Haak

TYPE	KLEUR	L · W · H (MM)	ORDERCODE
3-fase track	Wit	26-28-48	9 0 0 1 4 2 8 4
3-fase track	Zwart	26-28-48	9 0 0 1 4 2 8 5

COVER en EINDKAP

Eindkap

TYPE	KLEUR	L · W · H (MM)	ORDERCODE
3-fase track links/rechts	Wit	32-32-38	9 0 0 1 4 2 1 6
3-fase track links/rechts	Zwart	32-32-38	9 0 0 1 4 2 1 7

Track Cover

TYPE	KLEUR	L · W (MM)	ORDERCODE
3-fase track 1,0 m	Wit	1000-26	9 0 0 1 4 2 3 6
3-fase track 1,0 m	Zwart	1000-26	9 0 0 1 4 2 3 7