

AURA Collection

The AURA wall lamp is realised without aesthetic distraction. Its design is based on the distinctive design style of LIGHT-POINT, combining clean lines with technical precision.

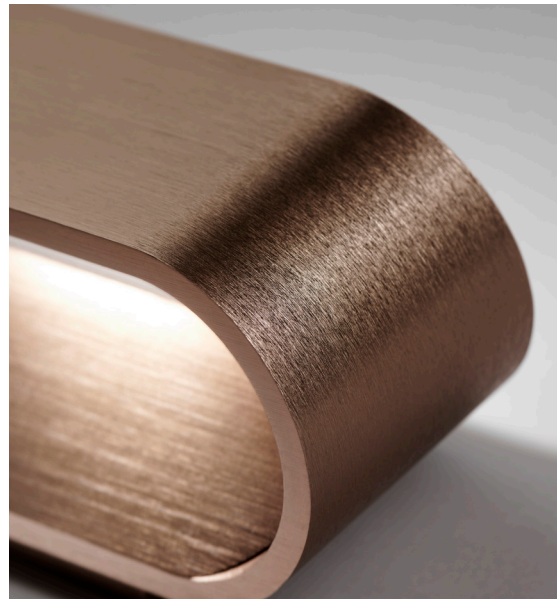

AURA User instructions



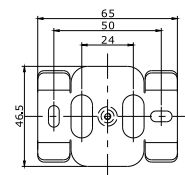
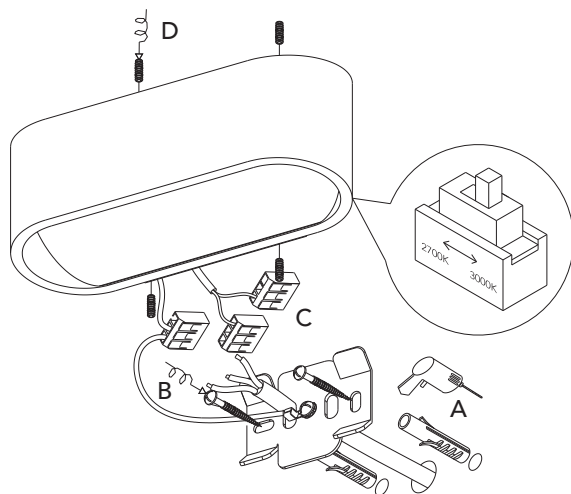

AURA W1

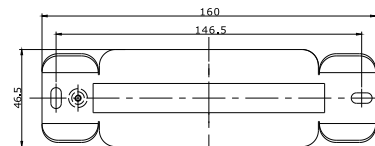

AURA W2

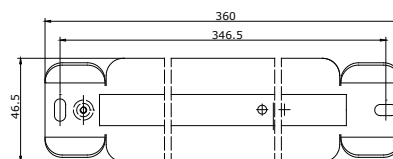

AURA W3

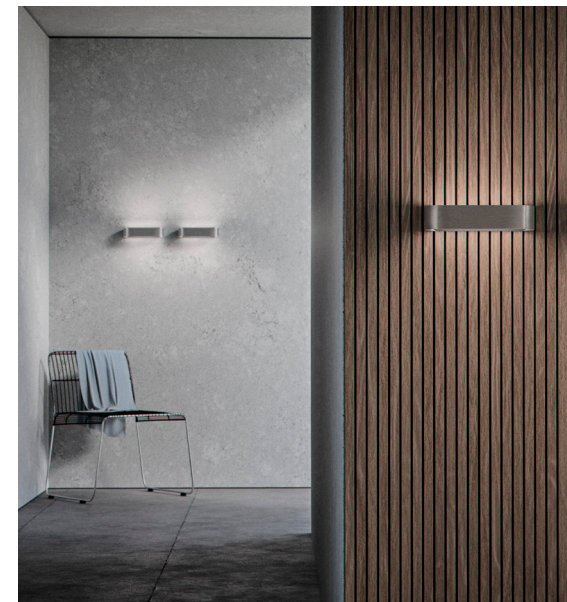

Installation instructions

- Before installing, make sure the power supply is switched off.
- Follow the steps as the figure for installation.
 - After drilling, pull out the wires.
 - Fix the mounting bracket onto the wall with screws.
 - Connect the wires to the terminal block.
 - Fix the fixture to the mounting bracket with screws.
- After finishing every step, tighten the screws, have the fixture fixed, and then connect the power supply.

NOTE: In case of any doubt, please contact the qualified electrician.

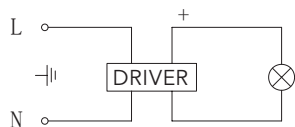

General use

The product is designed for indoor use.
The lamp gets hot after prolonged use, therefore, do not cover the product.

Cleaning instructions

- Before cleaning, ensure that the power supply is switched off.
- Wipe surface of lamp shade with a soft cloth.
- Do not use any abrasive cleaning tools such as steel wool, scouring sponges or stiff brushes.
- Never use strong cleaning agents such as white spirit, household glass cleaner or cellulose thinners.

Safety precautions

- The appliance should be installed, connected and tested by qualified electrician and in accordance with local regulations.
- Turn off the power supply before installation or maintenance of the lamp, and make sure that the cables are not squeezed or damaged by sharp edges during installation.
- The lamp should not be covered by insulation blankets or similar materials.

International warranty

Your product has gone through rigorous testing in order to live up to the highest quality standards. It therefore carries a 7-year warranty from the date of the original retail purchase receipt, covering defects in materials and workmanship when used normally in accordance with the published LIGHT-POINT guidelines.

These guidelines include but are not limited to information contained in technical specifications, safety instructions and quick start guides. LIGHT-POINT is not responsible for damage arising from failure to follow instructions relating to the use of the product.

LIGHT-POINT is a registered trademark of NORDIC LIVING GROUP.

For more information, please visit
LIGHT-POINT.COM

