



LIGHT·POINT

INSTRUCTION MANUAL

LANTERNG1 Code 257526	
LANTERNG2 Code 257530	
LANTERNG3 Code 257534	
INPUT: 220-240V ~ 50/60Hz CLASS I 	IP54  
LAMP-HOUSE: LED-1x8W/1x12W/1x15W	
MATERIAL: ALUMINIUM	

INSTALLATION INSTRUCTION

1. Before installing, make sure the power supply is switched off.
2. Follow the steps as the figure for installation 1:
 - A. drilling and pull out the wires
 - B. connect the wires.
 - C. fix the body to the bracket.
3. After finishing every step, tighten the screws, have the fixture fixed, and then connect the power supply.

CLEANING INSTRUCTION

1. Before cleaning, ensure that the power supply is switched off.
2. Use only a soft cloth to clean the lamp, dampened with mild cleanser if needed for resistant dirt.
3. Warning: do not use alcohol or other solvents

CAUTION:

In case of any doubt, please contact the qualified electrician.

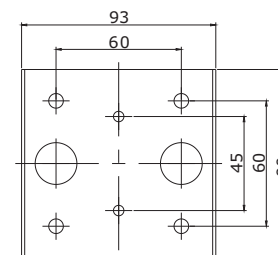
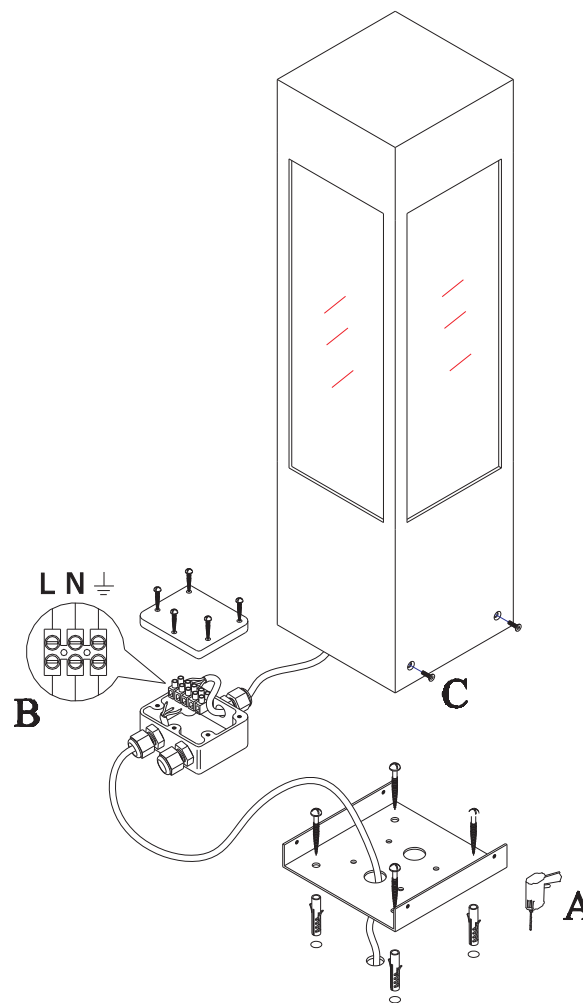
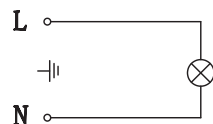

LANTERNG1

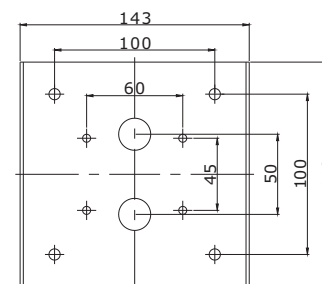

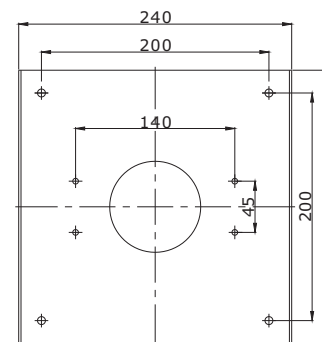

LANTERNG2



LANTERNG3

LIGHT·POINT

MONTAGEANLEITUNG

LANTERNG1 Code 257526	
LANTERNG2 Code 257530	
LANTERNG3 Code 257534	
INPUT: 220-240V ~ 50/60Hz CLASS I	⊕
LAMP-HOUSE: LED-1x8W/1x12W/1x15W	
MATERIAL: ALUMINIUM	
IP54  	

MONTAGEANLEITUNG

1. Stellen Sie vor der Installation sicher, dass die Stromversorgung abgestellt wurde.
2. Führen Sie die Schritte anhand der Anleitung für die Anbringung
 1. A. Ziehen Sie die Kabel heraus, nachdem Sie die Löcher gebohrt haben.
B. verbinden sie die Kabel.
C. befestigen Sie das Gehäuse.
3. Nachdem Sie jeden Schritt ausgeführt haben, ziehen Sie bitte die Schrauben fest, um den Aufsatz zu fixieren und verbinden Sie diese mit der Stromversorgung.

Reinigungsanweisung

1. Stellen Sie vor der Reinigung unbedingt sicher, dass die Stromversorgung abgeschaltet ist.
2. Nutzen Sie zur Reinigung der Lampe nur ein weiches Tuch - je nach Schmutzintensität mit einem milden Reiniger getränkt.
3. Warnung: Nutzen Sie keine Alkohole oder andere Lösungsmittel.

Achtung:

Kontaktieren Sie im Zweifelsfall einen qualifizierten Elektriker.

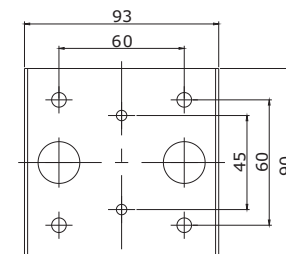
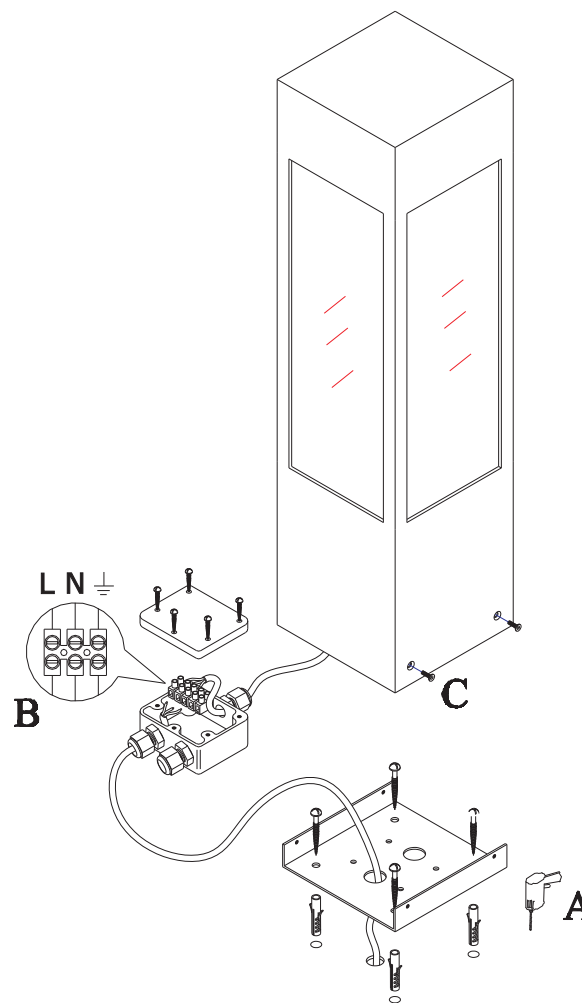
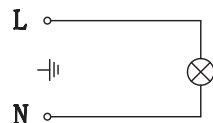

LANTERNG1

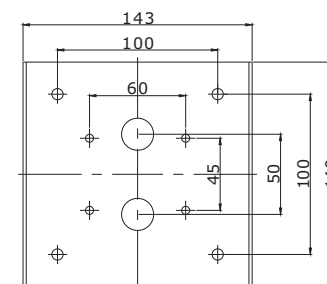

LANTERNG2

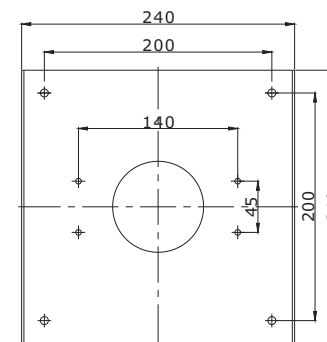

LANTERNG3