

Luna L Black Corner
2869.650

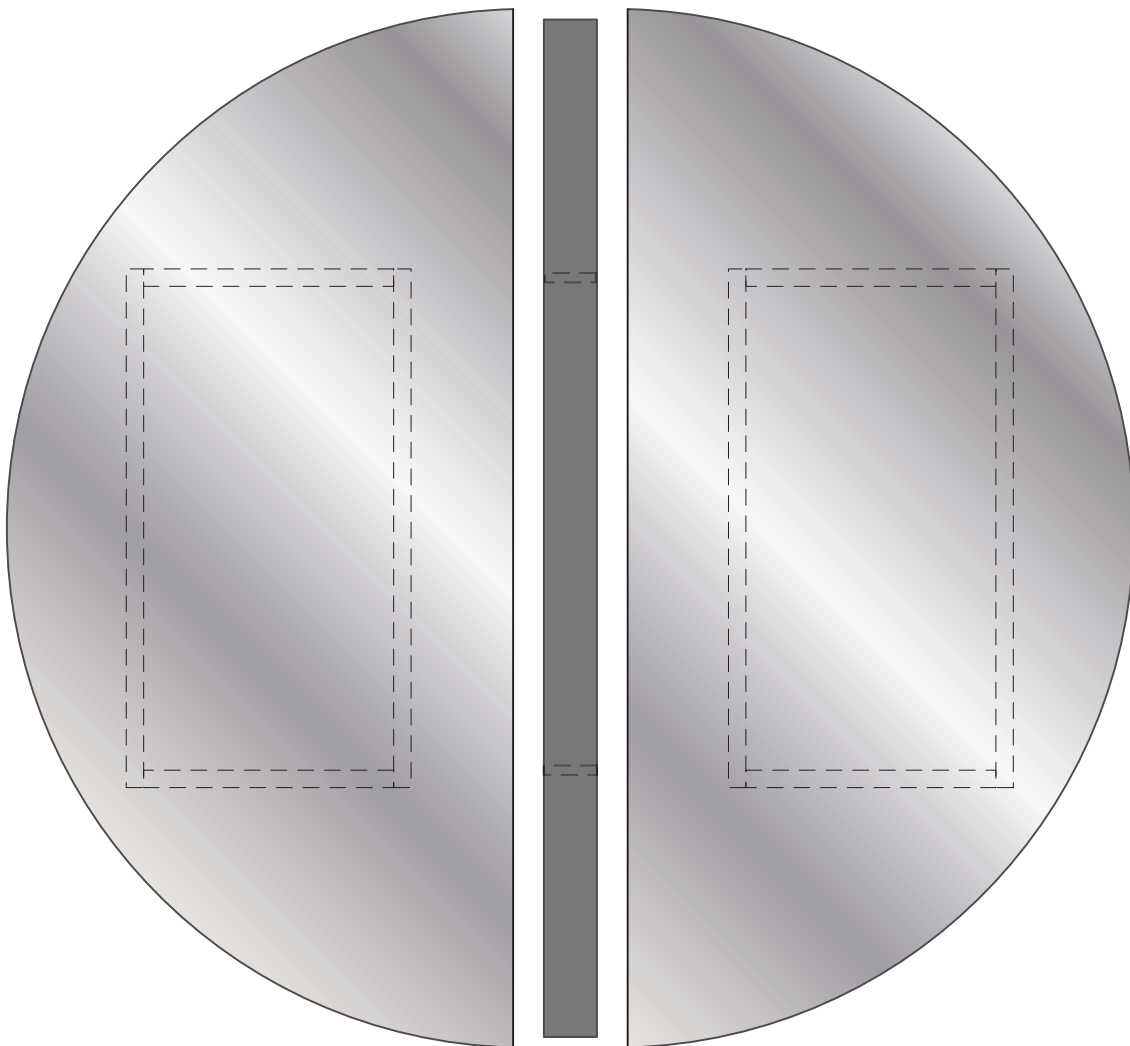

deknudtmirrors.com | Products | Luna L Black corner | scroll to INSTRUCTION MANUAL

suspension accessories delivered with the mirror

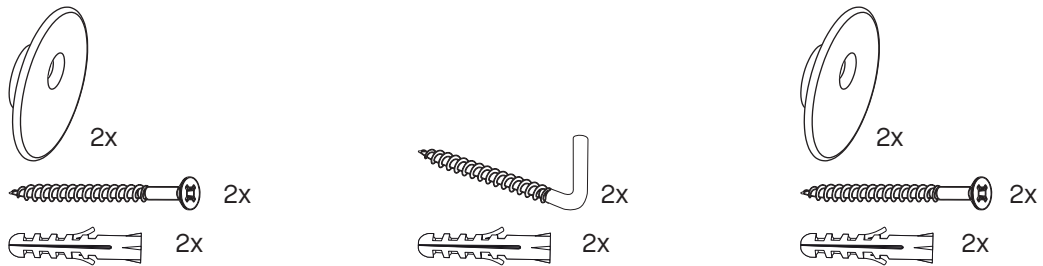

mark the suspension point on your wall
drill holes and place the plugs, washers and screws or plugs and hooks

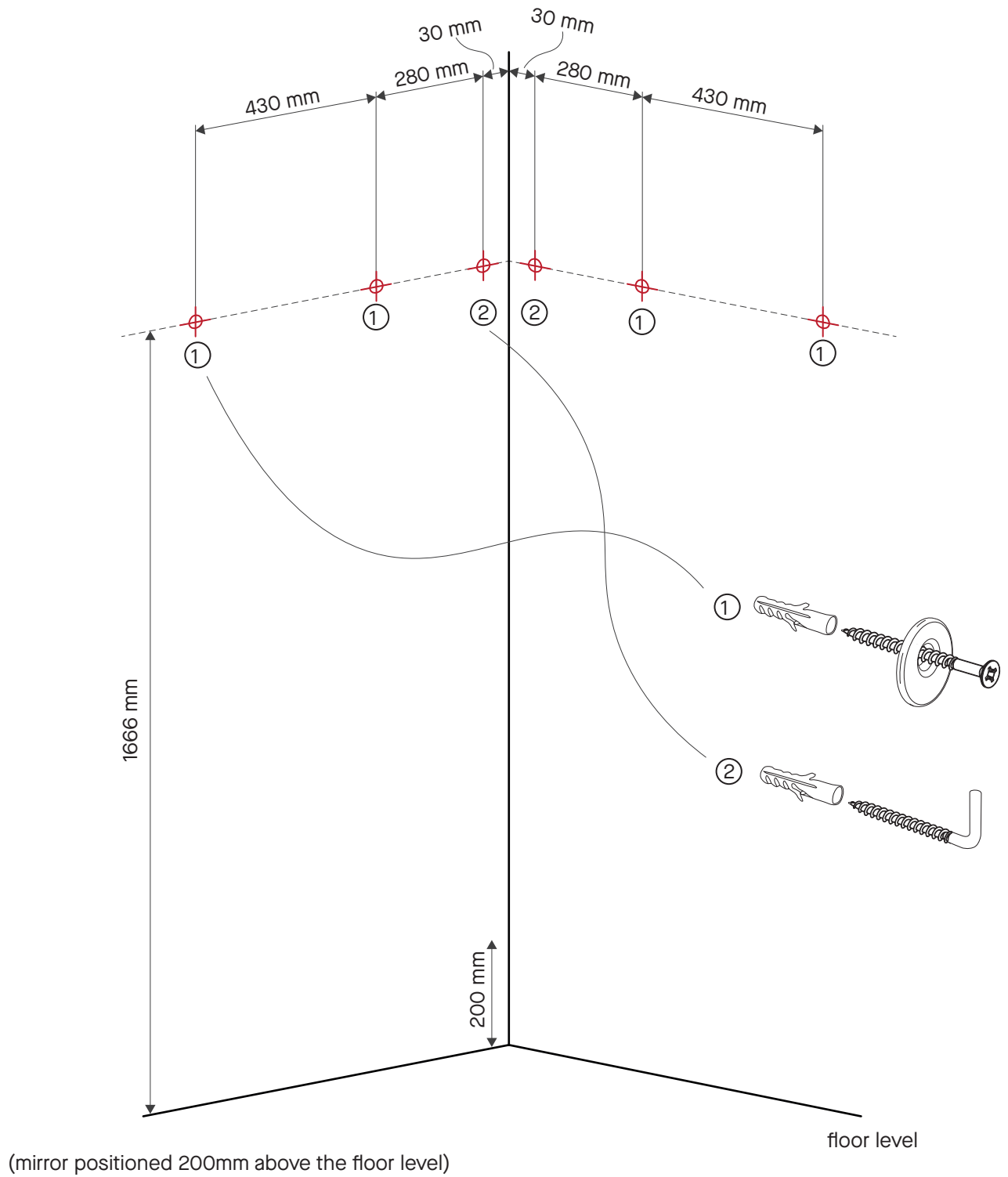

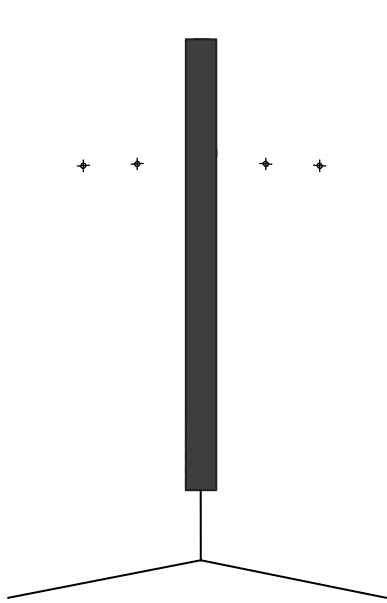

place the central element on the hooks making sure the hooks are inserted in the slots

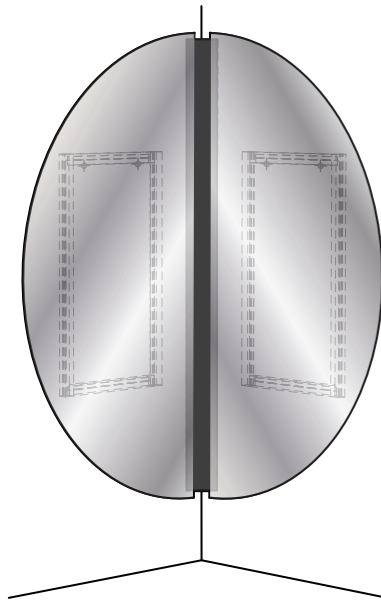

place the 2 mirrors on the washers

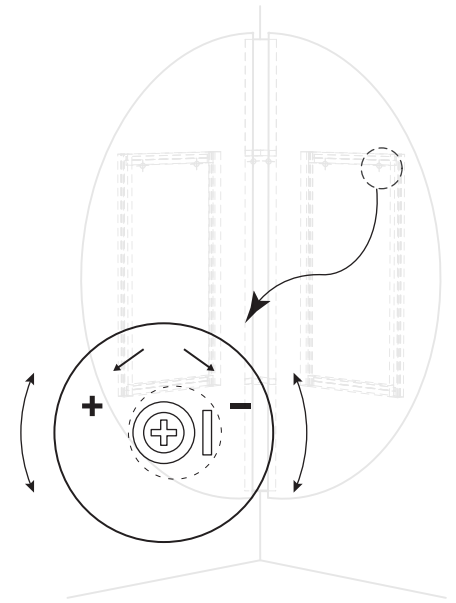

by turning the washers you can slightly adjust the level of the mirrors

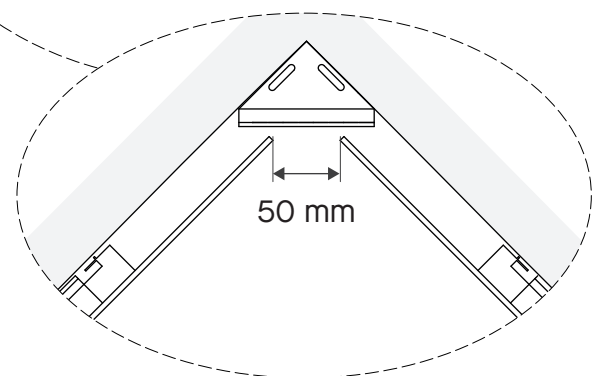
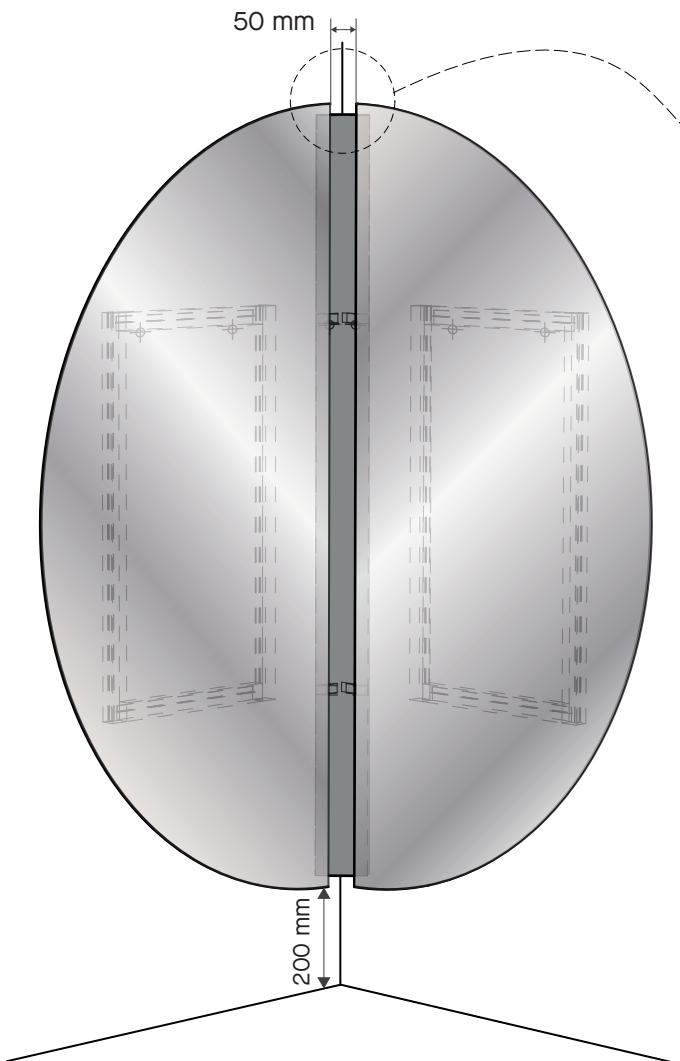

slide the mirrors in order to leave a 50mm gap and show the central element