

CENO semi recessed

INSTALLATION INSTRUCTIONS | NOVEMBER 2022

DIMENSIONS

1.0 SEMI RECESSED

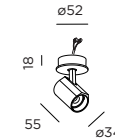

MOUNTING INSTRUCTION

- 1 Make a ceiling cut-out according to shown measurements and place the driver in the ceiling. Note that some drivers will not fit through this cut-out and will have to be placed through an inspection hole.
- 2 Push the mounting base horizontally as shown to unlock it from the luminaire and mount it on the ceiling with screws (screws are not included).
- 3 POWER CONNECTION
Always use a driver according to the specifications of the LED module.

Single connection



Connect to driver.

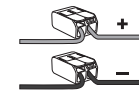

Multiple connection

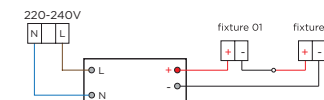

- 4 Attach the luminaire back to the mounting base.
- 5 Lock the luminaire on the mounting base by pushing the luminaire horizontally as shown.

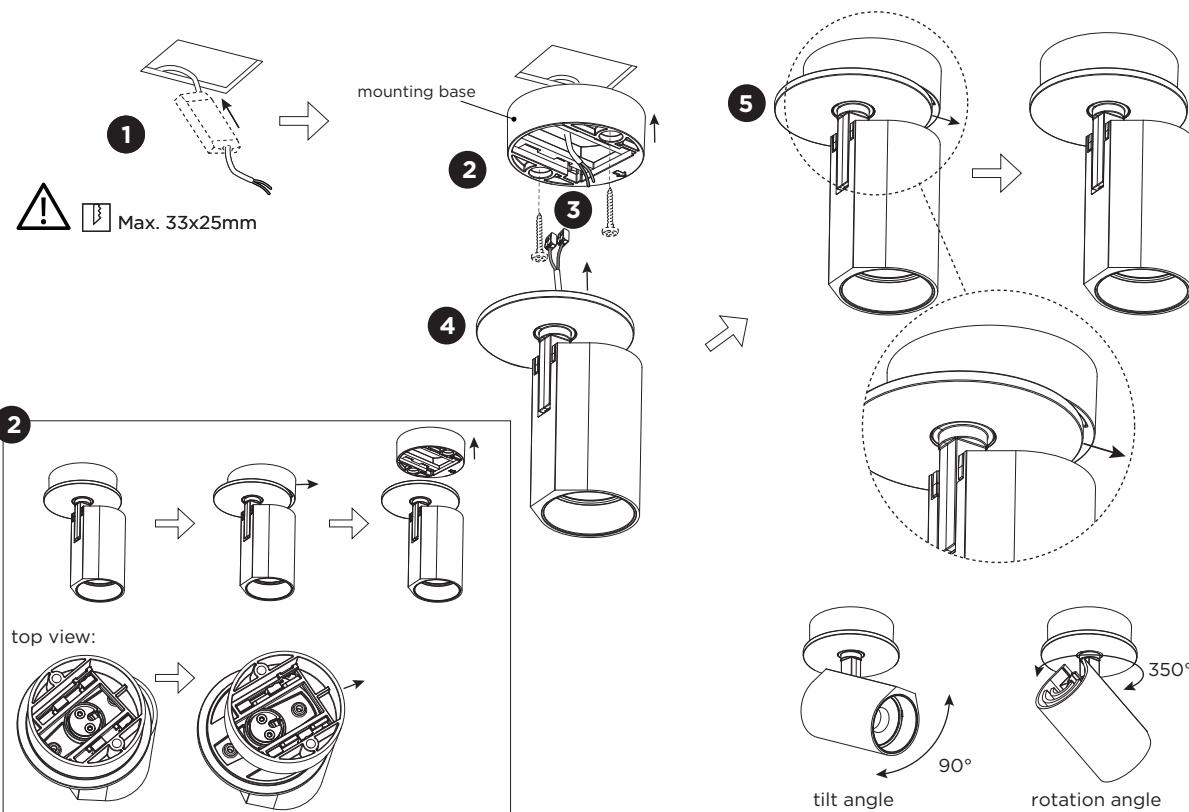

Mounting base:

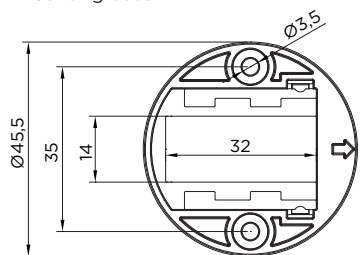

Only to be installed outside arms reach.

Driver must be powered off before connecting cables.

Before connecting the luminaire/LED module to the driver please make sure the driver is not powered but disconnected from the mains. The driver can only be powered when the luminaire/LED module is already connected. Disregarding this instruction might damage or even destroy the luminaire/LED module.

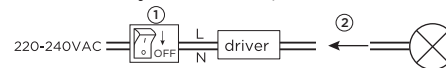

CENO semi recessed

INSTALLATION INSTRUCTIONS | NOVEMBER 2022

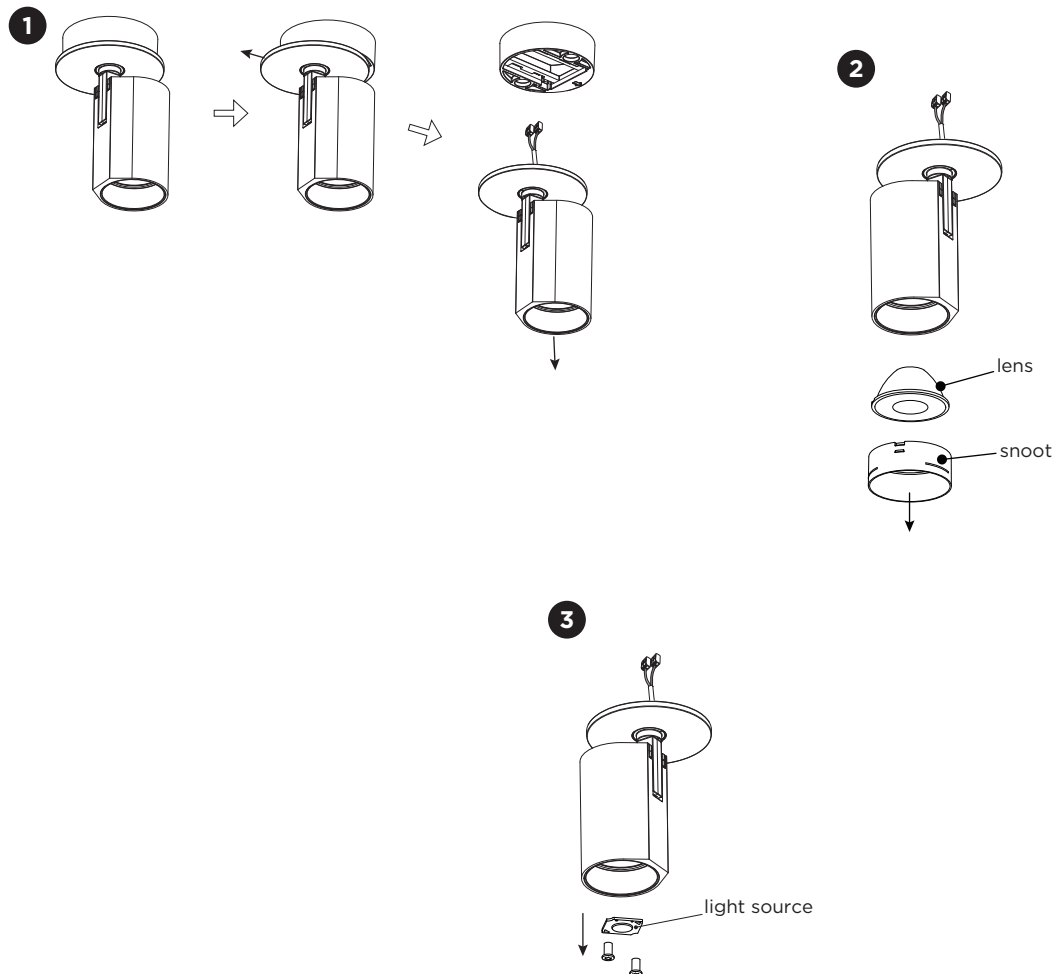

DISMOUNTING AND RECYCLING INSTRUCTIONS

Light source

- 1** Dismount the fixture from the ceiling by sliding it in the opposite direction on the mounting base and loosening the wiring.
- 2** Pull out the snoot and lens.
- 3** Unscrew the screws and remove the light source.



The light source is replaceable by an authorized professional.
For advice contact your Wever & Ducre customer service contact point.



This luminaire contains a light source with the energy class E.